



aquatherm green pipe

Pipe system made of polypropylene
for potable water supply

aquatherm blue pipe

Pipe system made of polypropylene
for chilled, hot fluid and various industrial applications

aquatherm lilac pipe

Pipe system made of polypropylene
for reclaimed water



aquatherm
state of the pipe



NEW SINCE THE LAST VERSION

D10101

aquatherm green pipe

aquatherm blue pipe

aquatherm lilac pipe

Page	Change
23	Ring Stiffness of aquatherm blue pipe and aquatherm green pipe
31	Revision Fire Protection
97	Form Chemical Resistance
106	Planning & design of compressed air applications
from 109	The article list was updated



Dear readers,

We are always making decisions – in every minute of every hour of every day. At this moment, you have decided to open our catalogue to consciously find out more about our company aquatherm.

Without knowing the reason behind your decision, we can promise you one thing, namely that the insight into our colourful, yet always slightly green tinged, aquatherm world is sure to impress you!

As a family business which is passionate about all it does we, together with our employees, confidently meet all challenges and, in doing so, are able to trustfully call upon values which have defined our company for already more than four successful decades.

We know where we want to go without forgetting where we came from. Hereby we like to live with the role of not being a “normal” business. The characteristics “being different” and “special” represent our motivation in all that we do to be the best.

We are “state of the pipe” because we act independently and decisively and are hereby always reliable which makes us the leading manufacturer of polypropylene pipes.

We were, are and will remain as this – promise!

But see for yourself and decide upon aquatherm not only in the next few moments but also in the long term.

Best wishes

Dirk Rosenberg
Managing Director

Maik Rosenberg
Managing Director

Christof Rosenberg
Managing Director

Gerhard Rosenberg
President of the Advisory Board

- 1973 aquatherm founded by Gerhard Rosenberg
- 1977 First exports to Jordan and Belgium
- 1978 Move to the first building at the current site in Biggen
- 1984 Opening up of further foreign markets including Italy and Greece
- 1990 Market launch of the fusiotherm stabi composite pipe
- 1991 Subsidiary plant opens in Radeberg
- 1996 Takeover of turning shop aquatherm Metall GmbH & Co. KG, Attendorf
- 1996 First certification of our quality management system in accordance with ISO 9001
- 1997 Independent sales in Italy
- 1999 Market launch of the fusiotherm fibre composite pipe
- 2001 aquatherm operates in more than 50 export markets
- 2004 Dirk and Maik Rosenberg join management
- 2005 Market launch of the aquatherm black system
- 2006 Market launch of the aquatherm blue pipe
- 2006 aquatherm products permanently represented on all 5 continents
- 2008 Market launch of the aquatherm red pipe
- 2010 System expansion of the pipe size to max. ø630 mm
- 2010 Dirk, Maik and Christof Rosenberg assume company management
- 2011 Market launch of aquatherm ti
- 2012 First time certification of our environment management system in accordance with ISO 14001
- 2012 Market launch of the material PP-RP
- 2013 First certification of our energy management system in accordance with ISO 50001
- 2013 Brand conversion “colours of innovation” and aquatherm 40th jubilee
- 2015 Independent sales in North America
- 2017 Opening of the new pipe extrusion
- 2018 Independent sales in England
- 2018 Move of the injection moulding department to the new hall complex

SERVICE

TECHNICAL HOTLINE +49 (0)2722 950 200

info@aquatherm.de www.aquatherm.de

Parent plant Attendorn

aquatherm GmbH
Biggen 5
D-57439 Attendorn
Phone: +49 (0) 2722 950-0
Fax: +49 (0) 2722 950-100

Subsidiary Radeberg

aquatherm GmbH
Wilhelm-Rönsch-Str. 4
D-01454 Radeberg
Phone: +49 (0) 3528 4362-0
Fax: +49 (0) 3528 4362-30



Field staff

Whether briefing on site, system briefing in your workshop or counter events and tool days at the specialized trade: In addition to the regular training in Attendorn, the aquatherm field staff is every day and everywhere in Germany on the way.

A list of our globally active partners can be found on our website www.aquatherm.de in the category „service“.



Training

In addition to the proven lectures and counter events in the specialized trade and the training at the guild associations, aquatherm regularly offers specialist seminars and information events at the training center in Attendorn.

Fairs

aquatherm is represented with its own booth at all important fairs relevant for the heating and sanitary sector in Germany and abroad. Information regarding exact dates in your area can be found on the internet at www.aquatherm.de in the „service“ area.

Certifications in accordance with ISO 9001, 14001 & 50001

Since 1996 aquatherm fulfills the requirements of the quality management system according to DIN ISO 9001. The 2012 TÜV certificate was extended by the environmental management system according to ISO 14001 and currently by the energy management system according to ISO 50001.

This success is another step towards strengthening our competitive position and to meet the high requirements and the responsibility for our customers, partners and the environment.



Management System
ISO 9001:2015
ISO 14001:2015
ISO 50001:2011

www.tuv.com
ID 0091005348



Laboratory

From testing of granulate properties to permanent process monitoring: Only perfect goods have the chance to leave aquatherm.



Software service

The aquatherm software service provides Datanorm files, BIM-compatible files, an independent graphical configuration program (liNear) as well as the appropriate training on site.



Brochures and more

No matter if brochures, catalogues or product lists: everything is developed in our in-house advertising department. All documents can be downloaded in PDF-form from our website www.aquatherm.de. For printed copies just send an e-mail to info@aquatherm.de.

SERVICE

TABLE OF CONTENTS

Systems	8–23
– Rebranding	8–9
– Short cuts & Symbols	10
– aquatherm pipe systems	11
– Comparison of the water content per meter	12
– aquatherm green pipe/Application	13–15
– aquatherm blue pipe/Application	16–18
– Composite technology	19
– aquatherm blue pipe OT	20
– aquatherm TI	21
– Ring stiffness aquatherm blue pipe/aquatherm green pipe	22
– aquatherm lilac pipe/Application	23
Features	25–39
– Permissible working pressure – Potable Water	25
– Permissible working pressure – Non Potable Water	26
– Permissible working pressure for general pressure pipe applications in permanent operation	27
– System overview	28–29
– Characteristic	28
– Installation	28
– Composite Technology	28
– Quality	28
– Guarantee	29
– Price	29
– Material	30
– fusiolen®	30
– Certificates/aquatherm & Ecology	31
– Sound Insulation/Hygienic suitability	31
– Environmental Product Declaration and LEED certification	32
– Fire protection/Fire load	33–36
– UV-resistance/Chemical and thermal disinfection	38
– Integration of other systems or components with aquatherm piping for pressure pipe applications	39
Quality assurance	40–44
– Quality assurance	40
– Compliance with the system standard/aquatherm quality management	41
– System control/Internal control	42–43
– External control	44
Welding technology	45–72
– Fusion	46–72
– Part A: assembly of welding tools	46
– Part A: Mounting of the tools	47
– Part A: Heating up phase/handling	48
– Part A: Guidelines	49
– Part B: Checking of devices and tools	49
– Part B: Heating of pipe and fitting	50
– Part B: Universal peeling tools	51–52
– Part C: Weld-in saddles	53–56
– Part D: Pulling jig (hitch)	57–59
– Part E: aquatherm welding machine	60
– Part E: Welding machine prisma-light	61
– Part E: Electrofusion device	62–64
– Part G: Possibilities of repair	65
– Part H: Butt-welding of pipe dimension 160–630 mm	66–67
– Welding defects and visual inspection of fusion seam	68–69
– Welding parameter	70–71
– Part E: Flange connections	72

TABLE OF CONTENTS

Installation principles	73–97
— Fastening technique/Fixed points/Sliding points	73
— Installation advice/Linear expansion/Concealed installation	73
— Installation in ducts	74
— Open installation/Calculation of the linear expansion	75
— aquatherm green pipe & aquatherm blue pipe	76
— aquatherm green pipe MF (faser composite pipe)	77
— aquatherm blue pipe MF (faser composite pipe)	77
— Pipe clamps	78
— Bending side/Expansion loop	79
— Pre-stress/Bellow expansion joint	80
— Length of bending side	81
— Length of bending side with pre-stress	82
— Support intervals	83–84
— Thermal insulation of hot water pipes	85
— Insulation thickness acc. to Decree for Energy Saving	86
— Pressure test/Test control/Measuring of the test pressures/Test record	87
— Leakage Test/Pressure diagram	88
— Test record	89
— Flushing of pipes/Earth wire/Transport and storage	91
— Water point connections	92
— Distribution block	93
— aquatherm distribution block	94
— Insulation for distribution block/aquatherm distribution block	95
— aquatherm distribution block: Example of applications – heating	96
— Chemical Resistance	97
Planning	99–107
— DIN 1988 T3/Maximum flow rate/ Principles of calculation/Calculation guide/Software	100
— Minimum flow pressure	101–103
— Coefficient of loss aquatherm green pipe fittings	104–106
— Planning & design of compressed air applications	106
— Coefficient of loss aquatherm green pipe distribution block	107
Product list	108
— aquatherm green pipe pipes	109
— aquatherm blue pipe pipes	116
— aquatherm lilac pipe pipes	120
— Fastening material	121
— Fittings	122
— Weld-in saddles	139
— Flange adapter & flanges	144
— Coupling Screws & back plate elbows	147
— Screwed connections and counter parts	147
— Electrofusion sockets	149
— Transition pieces & counterparts	151
— Distributors	164
— Valves and accessories	165
— Cutting tools, welding devices	174
— Welding machines and welding jig	175
— Butt welding machines & electrofusion device	176
— Peeling tools	177
— Saddle welding tools	180
— Drills & saddle peeling tool	182
— Hot tapping tool	184
Prefabrication	187
— Advantages aquatherm Prefabrication	187
— Product list	188

REBRANDING

The desire to avoid stagnation and continuously improve our products, as well as to find new fields of application and create solutions quickly, has resulted in some of the well-known aquatherm product groups. This often led to systems being named as they emerged and has resulted in naming conventions that no longer accurately convey the suitable applications for the pipe.

Another issue was that many of our pipes and systems have names that

do not relate to each other, and in turn do not relate those products to their parent company, aquatherm. Furthermore, other companies from different industries around the globe use similar names, creating confusion between aquatherm products and their products. The desired uniqueness of our system identification was lost.

Thus, the next logical step for us was to introduce a naming system that matches and unifies our products.

no.	new branding structure				Material/Glasfibrecontent GF[%]/ fire class. acc. ISO 11925	article-no.
	brand name	appendix				
		Standard Dimension Ratio	structure of pipe	special feature of pipe		
1	aquatherm green pipe	SDR 11	S		PP-R/GF0/E	10208 . . . 10248
2	aquatherm green pipe	SDR 7.4	S		PP-R/GF0/E	10806 . . . 10908
3	aquatherm green pipe	SDR 6	S		PP-R/GF0/E	10006 . . . 10110
4	aquatherm green pipe	SDR 7.4	MF		PP-R/GF7/E	70708 . . . 70738
5	aquatherm green pipe	SDR 7.4	MF	UV	inliner like 5 with black PE-coating	70758 . . . 70788
6	aquatherm green pipe	SDR 9	MF	TI	inliner like 5 with PU-Insulation and black PE-casing	1370711 . . . 1370738
7	aquatherm green pipe	SDR 9	MF	RP	PP-RP/GF7/E	370712 . . . 370744
8	aquatherm green pipe	SDR 9	MF	RP UV	inliner like 8 with black PE-coating	370762 . . . 370794
9	aquatherm blue pipe	SDR 11	S		PP-R/GF0/E	2010208 . . . 2010312
10	aquatherm blue pipe	SDR 7.4 / SDR 11 / SDR 17.6	MF		PP-R/GF7/E	2070708 . . . 2570154
11	aquatherm blue pipe	SDR 7.4 / SDR 11	MF	UV	inliner like 11 with black PE-coating	2070162 . . . 2070762
12	aquatherm blue pipe	SDR 7.4 / SDR 11	MF	OT	inliner like 11 with EVOH O2-barrier	2170114 . . . 2170712
13	aquatherm blue pipe	SDR 7.4 / SDR11	MF	TI	inliner like 11 with PU-Insulation and black PE-casing	2270111 . . . 2270142
14	aquatherm blue pipe	SDR 7.4 / SDR11	MF	OT-TI	inliner like 13 with PU-insulation and black PE-casing	2470711 . . . 2470138
15	aquatherm red pipe	SDR 7.4	MF	HI	PP-R/GF7/B-s1,d0	4170130 . . . 4170726
16	aquatherm lilac pipe	SDR 7.4 / SDR11	S		PP-R/GF0/E	9010212 . . . 9010808
17	aquatherm black system			OT		
18	aquatherm orange system		S	OT		
19	aquatherm grey pipe					

LEGEND			
S	single layer	UV	ultraviolet protected
M	multilayer	TI	isolated with PUR and external PE pipe
MF	multilayer faser	RP	raised pressure (resistance)
OT	oxygen tight	HI	hardly inflammable

fields of application										
potable water	HVACR	swimming pool	chemical fluids	recycled & reclaimed water	fire protection	compressed air	district heating	geothermal	shipbuilding sector	Refrigeration and air conditioning
●	○	●	●	○		○	●	●	●	○
●	○	●	●	○		○	●	●	●	○
●	○	●	●	○		○	●	●	●	○
●	○	●	●	○		○	●	●	●	○
●	○	●	●	○		○	●	●	●	○
●	○	●	●	○		○	●	●	●	○
●	○	●	●	○		○	●	●	●	○
●	○	●	●	○		○	●	●	●	○
	●	●	●	○		●	●	●	●	●
	●	●	●	○		●	●	●	●	●
	●	●	●	○		●	●	●	●	●
	●	●	●	○		●	●	●	●	●
	●	●	●	○		●	●	●	●	●
	●	●	●	○		●	●	●	●	●
					●					
				●						
	●									
	●									
●	○									

System recommended due to its technical advantages: ●
 Application of the system is suitable: ○

SHORT CUTS & SYMBOLS

short cuts structure of pipe	
S	single
M	multilayer
MF	multilayer faser
OT	oxygen tight
UV	UV resistant
TI	thermal insulation
HI	hardly inflammable

short cuts material	
PP	polypropylene
PP-R	polypropylene random
PP-RP	polypropylene with raised pressure
PB	polybutene
PE-RT	polyethylene with raised temperature resistance

FIELDS OF APPLICATION



Potable water application



Heating system construction



Connection heating and cooling



Underfloor heating



Wall heating



Ceiling heating and cooling



Industrial floor cooling



Industrial floor heating



Chilled water technology



Agriculture



Sports floor heating and cooling



Swimming-pool technology



Chemical transport



Rainwater application



Irrigation



Fire protection sprinkler-systems



Application in the field of ship building



District heating pipeline systems



Geothermal

aquatherm pipe systems

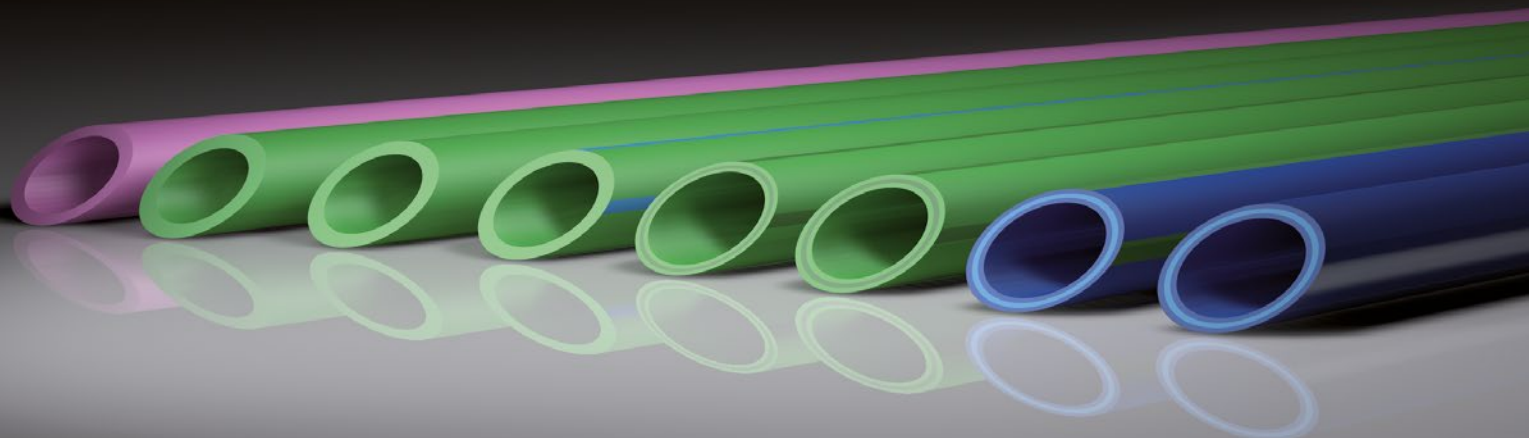

AQUATHERM PP-R-PIPE SYSTEMS

aquatherm offers pipe systems with many applications due to their special characteristics and versatility.

The aquatherm pipe systems are applied in all fields of

NEW INSTALLATION

REPAIR and

RENOVATION.

SYSTEM COMPONENTS

The systems including all elements for the pipe system installation for chilled, hot fluid and various industrial applications.

- Pipes in straight lengths and /or coils
- Fittings
- Flanged joints
- Water point connections and accessories
- Welding devices and machines
- Weld-in saddles
- Manifolds
- Shut-off devices
- Cutting and peeling tools
- Installation guide and fastenings
- Transition joints from PP-R to metal or from metal to PP-R

FIELDS OF APPLICATION

System recommended due to its technical advantages: ●

Application of the system is suitable: ○

aquatherm
green pipe

aquatherm
blue pipe

aquatherm
lilac pipe

	aquatherm green pipe	aquatherm blue pipe	aquatherm lilac pipe
Potable water application	●		
Heating system construction	○	●	
Climate technology	○	●	
Chilled water technology	○	●	
Swimming-pool technology	●	●	
Chemical transport due to high chemical resistance*	●	●	
Rainwater application	○		●
Irrigation	○	●	●
Compressed air systems	○	●	
Under-floor-heating-systems	○	●	
Application in the field of ship building	●	●	
District heating pipeline systems	●	●	
Geothermal		●	
Agriculture	●	●	●

* For resistance requirements, information regarding the medium and operating conditions (operating pressure and operating temperature) are required. The corresponding inquiry form can be found on page 97.

COMPARISON OF THE WATER CONTENT PER METER

Ø Dimension mm	aquatherm green pipe SDR 6 S	aquatherm green pipe SDR 7,4 MF aquatherm blue pipe SDR 7,4 MF SDR 7,4 MF OT aquatherm lilac pipe SDR 7,4 S	aquatherm green pipe SDR 9 MF RP	aquatherm green pipe SDR 11 S / MF aquatherm blue pipe SDR 11 MF SDR 11 MF OT SDR 11 S aquatherm lilac pipe SDR 11 S	aquatherm blue pipe SDR 17,6 MF
Ø 16	0,088	0,106	-	-	-
Ø 20	0,137	0,163	-	0,206	-
Ø 25	0,216	0,254	-	0,327	-
Ø 32	0,353	0,423	0,483	0,539	-
Ø 40	0,555	0,660	0,754	0,834	-
Ø 50	0,876	1,029	1,182	1,307	-
Ø 63	1,385	1,647	1,869	2,074	-
Ø 75	1,963	2,323	2,659	2,959	-
Ø 90	2,826	3,358	3,825	4,252	-
Ø 110	4,229	4,999	5,725	6,359	-
Ø 125	-	-	7,386	8,199	9,637
Ø 160	-	-	12,109	13,430	15,792
Ø 200	-	-	18,908	21,010	24,661
Ø 250	-	-	29,605	32,861	38,568
Ø 315	-	-	46,966	52,172	61,223
Ø 355	-	-	59,625	66,325	77,832
Ø 400	-	-	-	84,290	98,756
Ø 450	-	-	-	106,477	125,036
Ø 500	-	-	-	-	154,272
Ø 560	-	-	-	-	193,688
Ø 630	-	-	-	-	245,070

SDR = Standard Dimension Ratio (diameter/wall thickness ratio)

S = single layer

MF = multilayer faser

MF RP = multilayer faser – raised pressure (resistance)

OT = oxygen tight

aquatherm green pipe

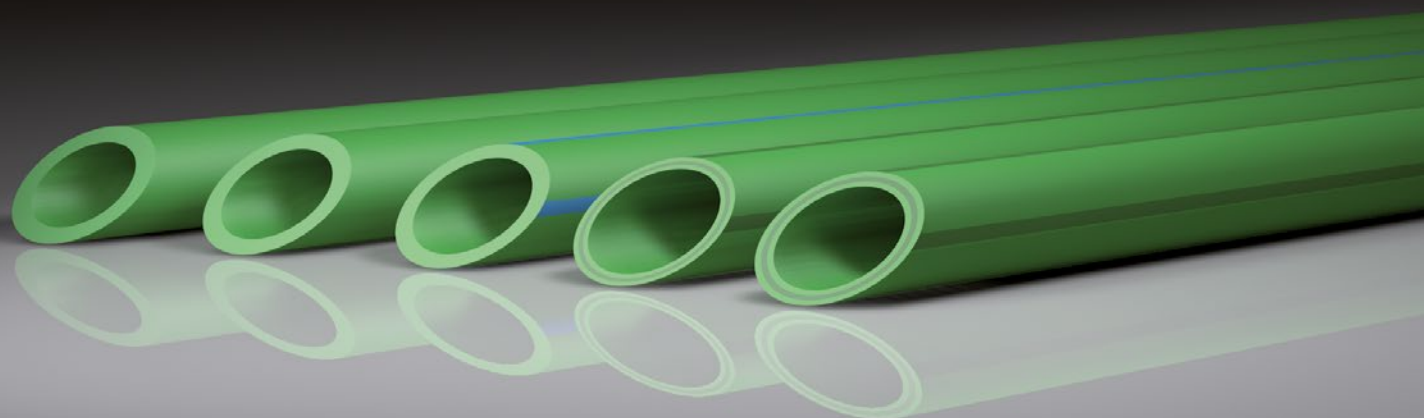

aquatherm green pipe

The innovative all-rounder, which revolutionized the plastic pipe sector, made a name for itself within a very short time that stands for highest quality and outstanding ecological properties. The system has proven its excellent technical suitability in more than 30 years of application worldwide, and among experts has long been one of the most extensive and at the same time best plastic pipe systems.

The system includes the different types of pipes SDR 6, SDR 7.4, SDR 9 and SDR 11. These are supplemented by the especially reinforced fiber composite pipe. More than 450 joining and connection elements as well as valves and ball valves complete the system.

The products are available from 16 mm to 450 mm external diameter.

aquatherm green pipe SDR9 RP

aquatherm sets the innovation standards in the production of PP-pipes and fittings worldwide. We continually bother to push developments for product improvement. The current level of evolution is called „fusiolen PP-RP“.

With „fusiolen PP-RP“ we can produce fibre-composite pipes with lower wall-thickness by keeping all the well-established advantages. Further advantages can be found on page 29.

The aquatherm green pipe system is applied in all fields of

- **NEW INSTALLATION**
- **REPAIR** and
- **RENOVATION.**

- **Potable water pipe networks**
cold and hot water installations e.g. in residential buildings, hospitals, hotels, office and school buildings, shipbuilding, sports facilities etc.
house connection
boiler connection
water distribution
rise
high rise (conventional or specially connected)
water point connection

- **Heating pipes for residential houses**
heat generator connections
heating manifolds
risers
high rise
manifold connections
radiator connections

- **Pipe networks in agriculture and horticulture**

- **Pipe networks for geothermal recovery**

- **Pipe networks for industry,**
the transport of aggressive fluids
(acids, leys etc.) considering the chemical resistance

Fields of application





aquatherm green pipe

POTABLE WATER AND HEATING INSTALLATIONS

From the house connection station, cold water distribution, boiler connection and hot water distributor to risers, installed with aquatherm green pipe composite pipe, with conventional high rise or high rise carried out with the aquatherm green pipe manifold system up to the last tap, installed conventionally or with the manifold, concealed or surface installation – the aquatherm green pipe system offers all possibilities of a complete installation with only one non-polluting material.

Types of installation

The aquatherm green pipe system is applicable for all common types of installation:

It is also possible to prefabricate pipe and fittings for risers and high rise.

aquatherm green pipe offers the perfect program for all types of installations.

With an extensive product range of pipe and fittings from Ø 16–450 mm external diameter and more than 450 fittings including fittings with brass threaded metal inserts, aquatherm green pipe offers ideal solutions for all fields of application.



House connection station

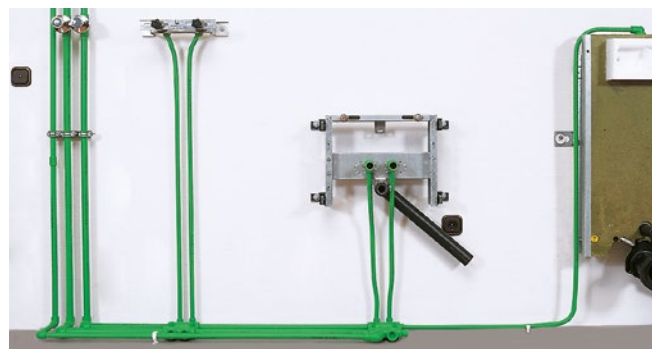

Surface installation



Concealed installation



Surface installation



Distribution network for domestic water and heating in residential buildings

All risers and distribution pipes are planned and assigned as usual.

1. Distribution piping with composite pipes

More dimensionally stable pipes are recommended for conventionally installed basement pipes, risers and multi storey pipe-systems.

Multi-storey installation can be done with the distribution blocks for plumbing and heating: quick processing is guaranteed.

Due to the low demand in fittings, the number of connections is reduced and thus time for installation.

High degree of pre-fabrication:

the special construction allows floor or wall installation (e. g. behind skirting boards) as one compact fitting with all branches provided.

2. Floor distribution with distribution blocks

The distribution blocks also offer further installation options: A simple opening of a side branch by drilling (18 mm borer) enables the connection of an additional pipe. e.g. the circulation pipe.

For further information concerning the distribution block plumbing and heating see page 93–95.

IMPORTANT:

The aquatherm grey pipe domestic water and radiator connection system is compatible with the aquatherm green pipe system.



Distribution piping



Floor distribution with distribution blocks



aquatherm grey pipe connection

aquatherm blue pipe

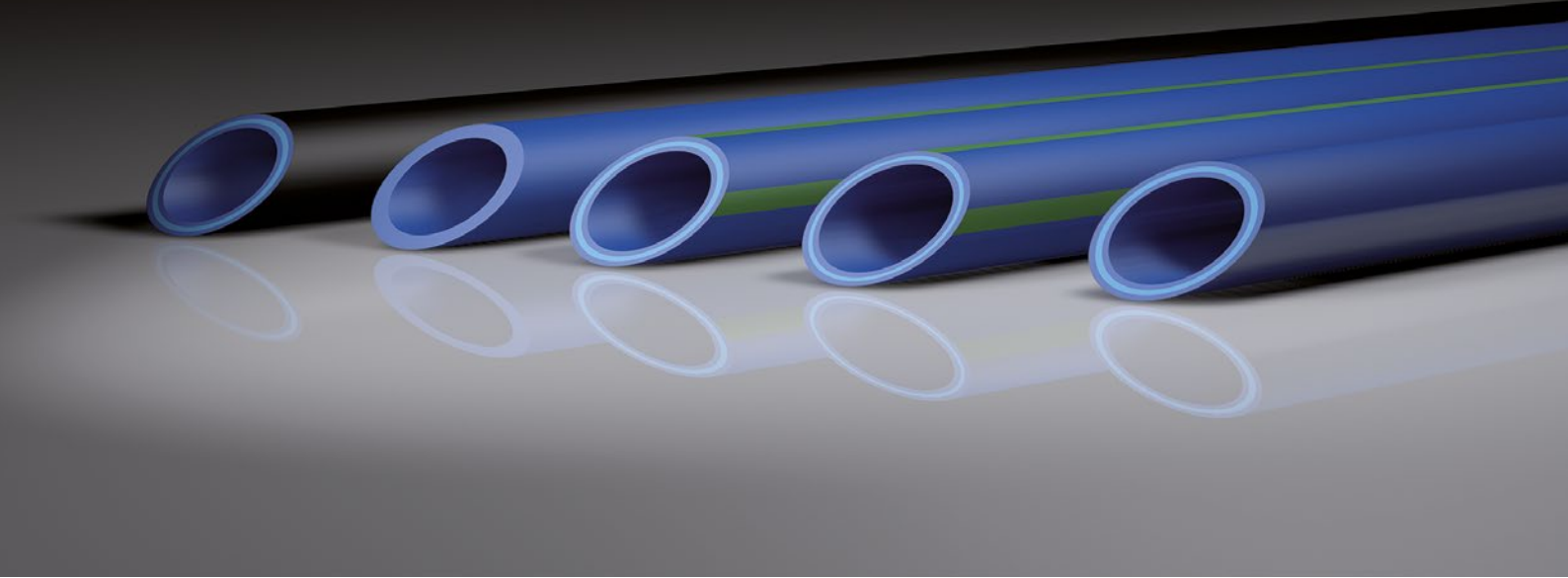

aquatherm blue pipe

aquatherm blue pipe, our specialty for distributing cooling and heating in closed and open systems as well as in several industrial applications. It was developed in order to prevent corrosion in heating system pipes and in cooling and refrigeration systems and quickly expanded its range of application, with many positive features for other fields of piping installation. It has gone on to find success around the world in hotels, stadiums, schools, offices, and industrial applications. In addition to the general advantages of the PP-R pipesystem aquatherm blue pipe in comparison with the aquatherm green pipe system it offers higher volumetric current values due to smaller wall thickness.

System components

The system has to be installed in combination with the aquatherm green pipe fittings – and includes all elements for the pipe system installation for chilled, hot fluid and various industrial applications.

aquatherm blue pipe stops corrosion damages!

Air conditioning systems (problems with dew-point) installed with steel pipes especially are affected by corrosion at the outer surface of the pipes. aquatherm blue pipe is manufactured from 100 % corrosion resistant materials which increase the life-time of air-conditioning pipe systems considerably.

Insulation against energy loss

Compared to metal pipes aquatherm blue pipes require a considerable thinner insulation.

The aquatherm blue pipe system is applied in all fields of

- **New installation**
- **Repair and**
- **Renovation.**

- **Heating pipes for residential houses**
 heat generator connections
 heating manifolds
 risers
 high rise
 manifold connections
 radiator connections

- **Pipe networks**
 climate technology
 chilled water technology
 swimming-pool technology
 chemical transport
 rainwater application
 compressed air systems
 under-floor-heating-systems
 ship building
 district heating
 geothermal

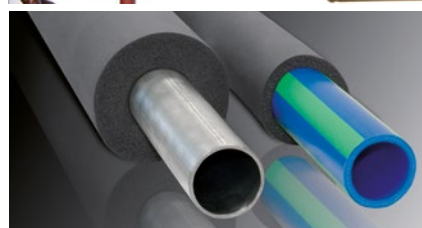

Fields of application



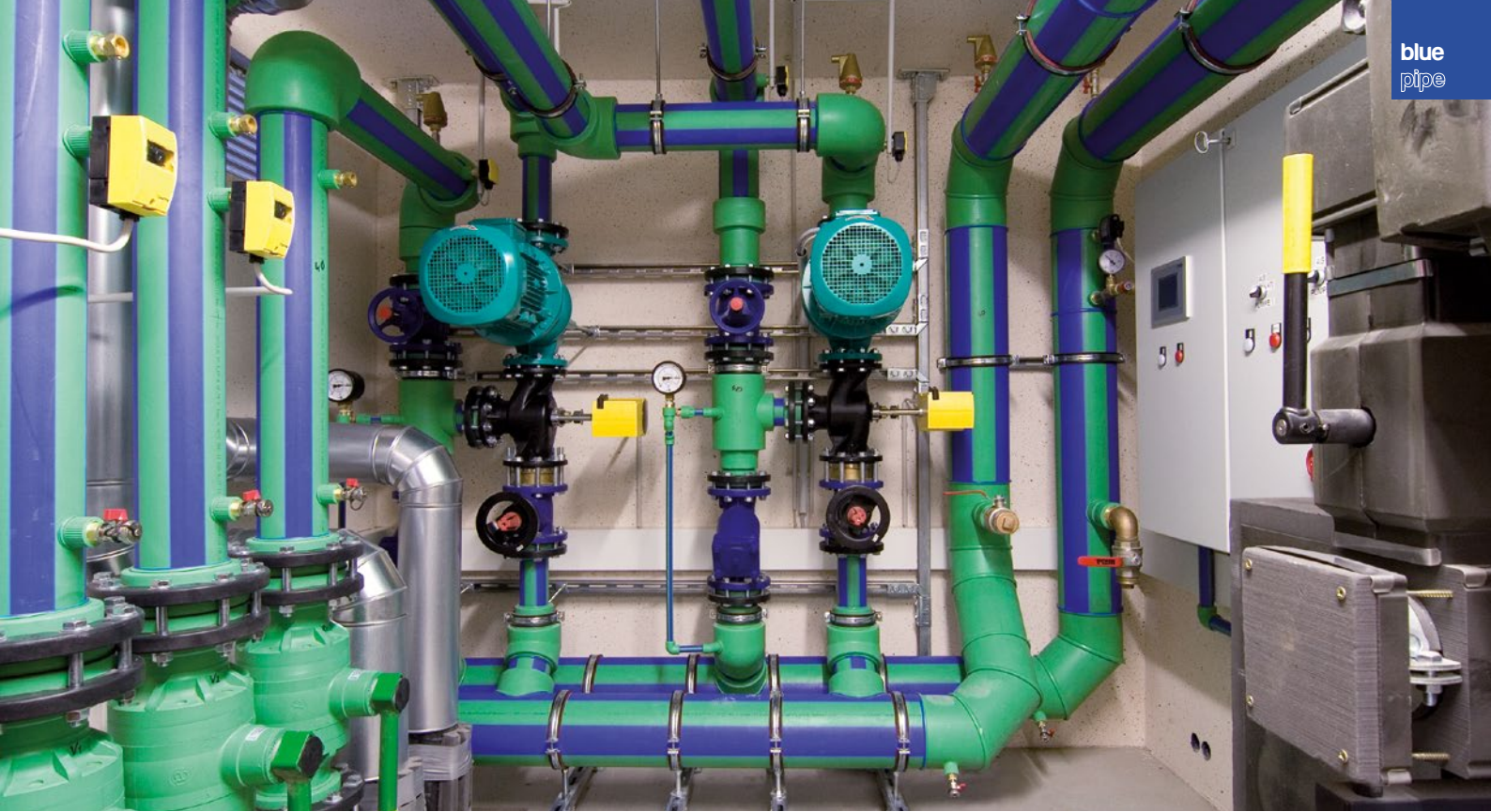

aquatherm blue pipe

Flange connections and transition joints enable the connection of all components to the central heating system and on the floor.



Risers and distribution piping for heating supply should be planned and installed with aquatherm blue pipe fiber composite pipes.

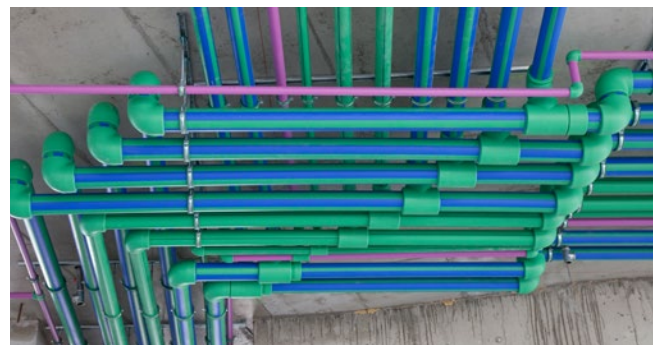

The connection of floor heating systems or the installation of radiator pipes up to the manifold can also be carried out with aquatherm blue pipe.





Heating and air-conditioning

aquatherm blue pipe includes all pipe installation components for chilled water, hot and various industrial applications. Reduced wall thickness offers higher flow rates and the products are stabilised under heat.



Ice surface cooling

The ice surface cooling system is made of an ideal combination of aquatherm blue pipe and aquatherm green pipe components. For the construction of mobile ice rink surfaces the pipework is completed with aquatherm blue pipe components.



The distribution pipes as well as the manifold connecting pipes are made from aquatherm blue pipes and connected by reverse return (Tichelmann-principle). The weld-in saddle technique, developed by aquatherm, is applied for the production of manifold branches.

Under soil heating

To keep a pitch with natural or artificial turf free from ice and snow aquatherm offers a system to provide an under soil heating efficiently and in consideration of environmental aspects.

The ideal combination of aquatherm blue pipe and aquatherm green pipe compounds creates this condition.



COMPOSITE TECHNOLOGY

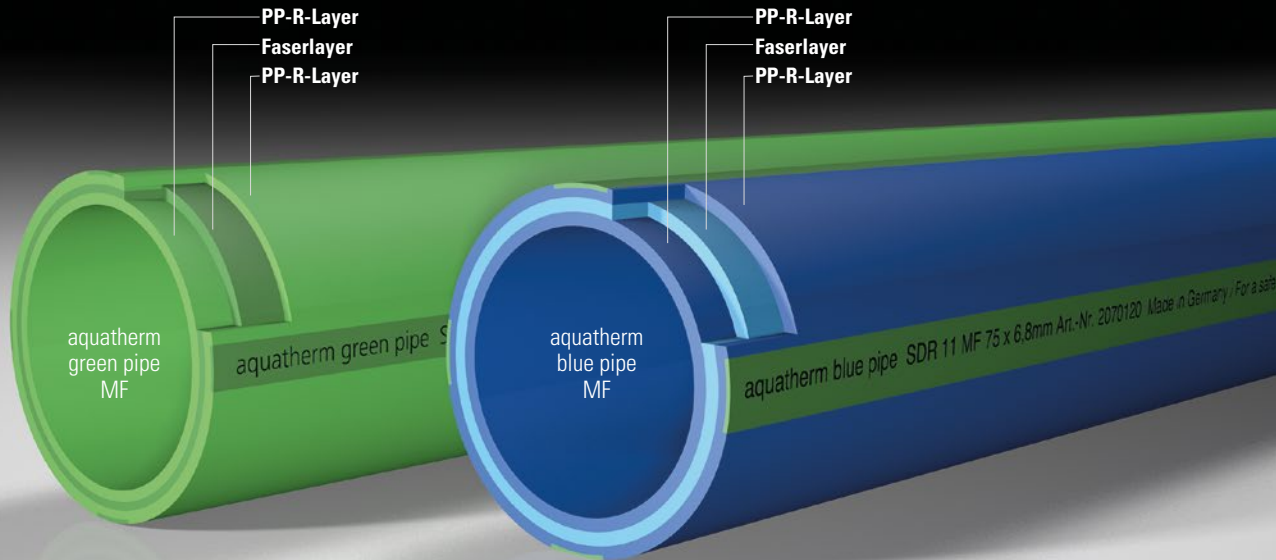

FASER COMPOSITE TECHNOLOGY

The composite pipes made in the multi-layer extrusion process produce a higher stability due to the fibre filling in the middle layer. Compared to customary PP-pipes there are further advantages:

- Reduced expansion
- Higher flow rate due to increased inner diameter
- Greater support spacings
- Less weight

The following types of pipe are produced according to this technology:

- aquatherm green pipe MF (Fasercomposite pipe)
- aquatherm blue pipe MF (Fasercomposite pipe)
- aquatherm red pipe MF (Fasercomposite pipe)

Expansion in comparison

Graph for determination of expansion

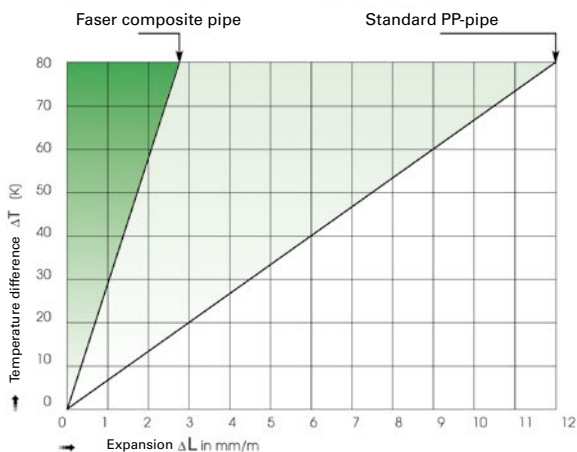

Support spacings PP-pipe and faser composite pipe

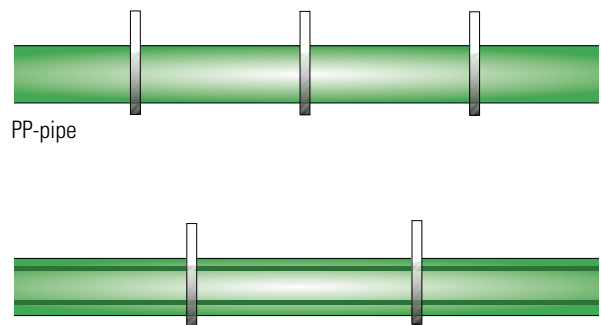

Faser composite pipe approx. 30 % more fixing distance

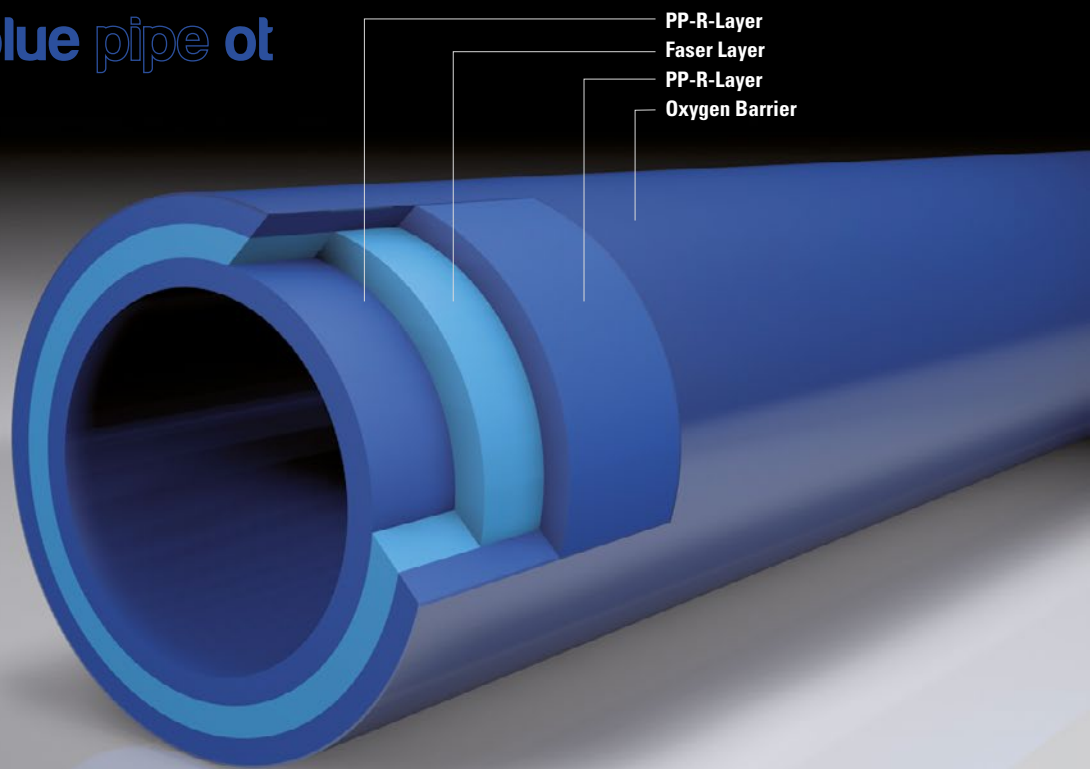

PP-R-Layer
Faser Layer
PP-R-Layer
Oxygen Barrier

aquatherm blue pipe ot

WITH OXYGEN BARRIER!

aquatherm blue pipe ot is an oxygen-tight pipe which is equipped with an oxygen barrier and thus corresponds to the requirements of DIN 4726.

The aquatherm blue pipe faser composite pipe OT in combination with the aquatherm blue pipe system includes all elements for the pipe installation of chilled, hot fluid and various industrial applications.

The advantages of aquatherm blue pipe ot:

- Oxygen tight by diffusion barrier
- Certified according to DIN 4726
- Absolutely corrosion resistant
- Less pipe friction
- High stability
- High heat-stability
- High environmental compatibility
- High impact rate
- Resistant against chemicals
- Heat- and sound insulating characteristics
- Very good welding properties
- Considerably thinner insulation

Easy and quick installation technology

aquatherm blue pipe faser composite pipe OT also convinces by easy but effective installation- and connection technology. By heating of pipe end and fitting the plastic melts after joining of the elements into a permanent connection.

aquatherm blue pipe faser composite pipes OT have to be peeled with peeling tools Art. no. 50479–50488 before processing.

aquatherm green pipe ti

aquatherm blue pipe ti

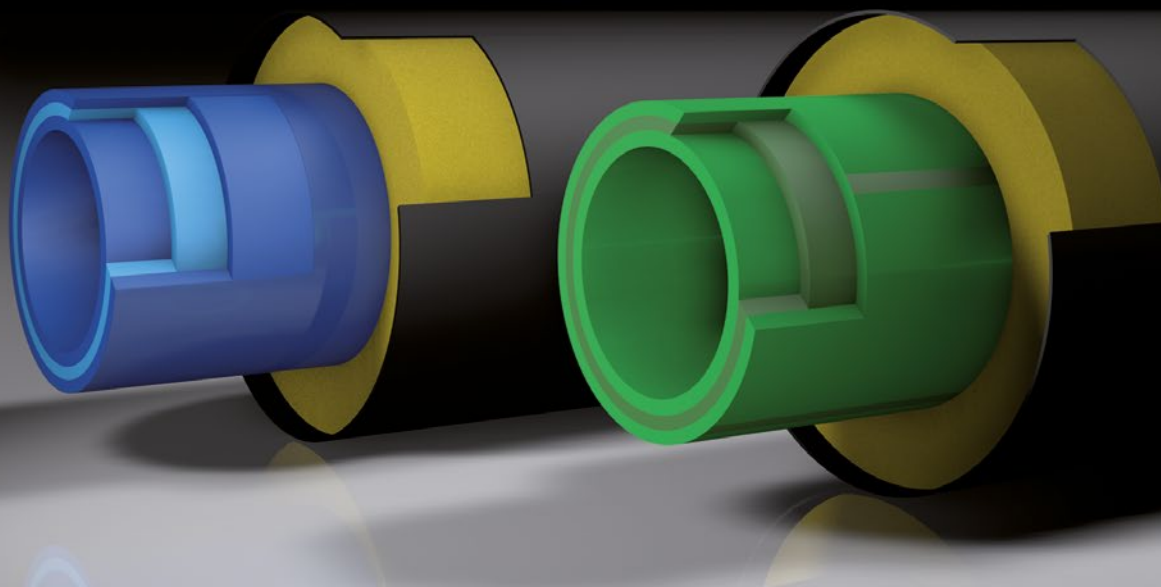

aquatherm ti – PRE INSULATED PIPE SYSTEMS

for district heating

One of the most energy-efficient methods of transporting hot potable water as well as heating or cooling water covering long distances is the application of underground piping. To achieve the necessary insulating characteristics for this type of application, aquatherm offers the factory-made pre-insulated aquatherm ti pipe system with different medium pipes.

These systems are insulated with closed cell PUR rigid foam and coated with a casing pipe made of HDPE.

All medium pipes are plastic-fibre composite pipes.

The pipe system is optionally also available with trace heating and mains monitoring. Special designs on request.

Medium pipes

- **aquatherm green pipe ti**
faser composite pipe system SDR 9 (7.4 on request available)
pipe system for potable water
in dimensions 32–315 mm
- **aquatherm blue pipe ti**
faser composite pipe system
SDR 11 in dimensions 32–315 mm and
SDR 17.6 in dimensions 160–315 mm
for heating, cooling and waste water
- **aquatherm blue pipe ot ti**
faser composite pipe system SDR 11
oxygen-tight pipe system for heating- and industrial
in dimensions 32–250 mm

Fields of application

	aquatherm green pipe ti	aquatherm blue pipe ti	aquatherm blue pipe ot ti
Potable water application	●		
Climate technology	○	●	●
Chilled water technology	○	●	●
Swimming pool technology	●	●	
Rainwater application	●	●	
Irrigation	●	●	
District heating pipeline systems	○	●	●
Application in the field of Shipbuilding	●	●	●
Industrial liquids considering the material resistance	●	●	●

System recommended due to its technical advantages: ●
Application of the system is suitable: ○

MORE INFORMATION

For more information on the aquatherm ti system, please see our aquatherm ti catalogue with the order-no. **E30000**. You can request at our Info-Service on telephone-no. **+49 2722 950-0** or download in the download area of our **www.aquatherm.de**.

RING STIFFNESS OF aquatherm blue pipe & aquatherm green pipe

The aquatherm blue pipes SDR 11 MF (90–400 mm) and SDR 17.6 MF (160–630 mm) have been tested according to DIN EN ISO 9969 with 3 % pipe deformation and have a ring stiffness of $\geq 16 \text{ KN/m}^2$. Thus, they are classified in the ring stiffness class SN16, which corresponds to the highest standard category. The same applies to aquatherm green pipe SDR 7.4 MF (20-355 mm).

Underground installation: The depth of the trench adds up from the depth of the frost line, the outer diameter of the pipe and the height of the bedding ($A+D_a+B$). The frost line must be observed: 0.5–9.0 m above the pipe peak (E). If the pipes are installed outside the specified laying depth, a load distribution by steel or concrete slabs must be installed.

Traffic load: SLW 60, heavy forklift (60 tons maximum load).

Trench design: Recommended calculation according to ATV A 127 (basis for calculation).

Laying conditions: We recommend laying the pipes in a narrow trench in which nevertheless sufficient space for working is available.

Bedding layer (B): In normal soil 100 mm sand with round graining size 0–8 mm.

When rock or rocky soils 150 mm sand with round graining size 0–8 mm.

This layer is equally compressed ($\geq 97 \%$ Proctor) with gaps in the socket area. Non sustainable soils are made stable by the choice of the bedding layer. Note planning requirements.

Backfilling: The building material 4/8 mm graining is filled in layers in order to construct the lateral bedding (C) and the covering (D). Thereby the peak of the pipe (E) is covered with minimum 100 mm. Then the main filling (F) with the excavation can be carried out. Note that the grain size does not exceed 300 mm respectively sharp and rough stones are removed. Planning requirements of the filling levels are always to be considered.

Each filling is compressed separately.

Compaction: The compression ($\geq 97 \%$ Proctor) of the lateral bedding (C) and the covering (D) is done by hand or with light equipment. If the main filling is made with minimum 20 cm, the trench can be compressed 95 % Proctor upwards from this layer with heavy equipment. The last 50 cm of the trench are compressed with 97–100 % Proctor.

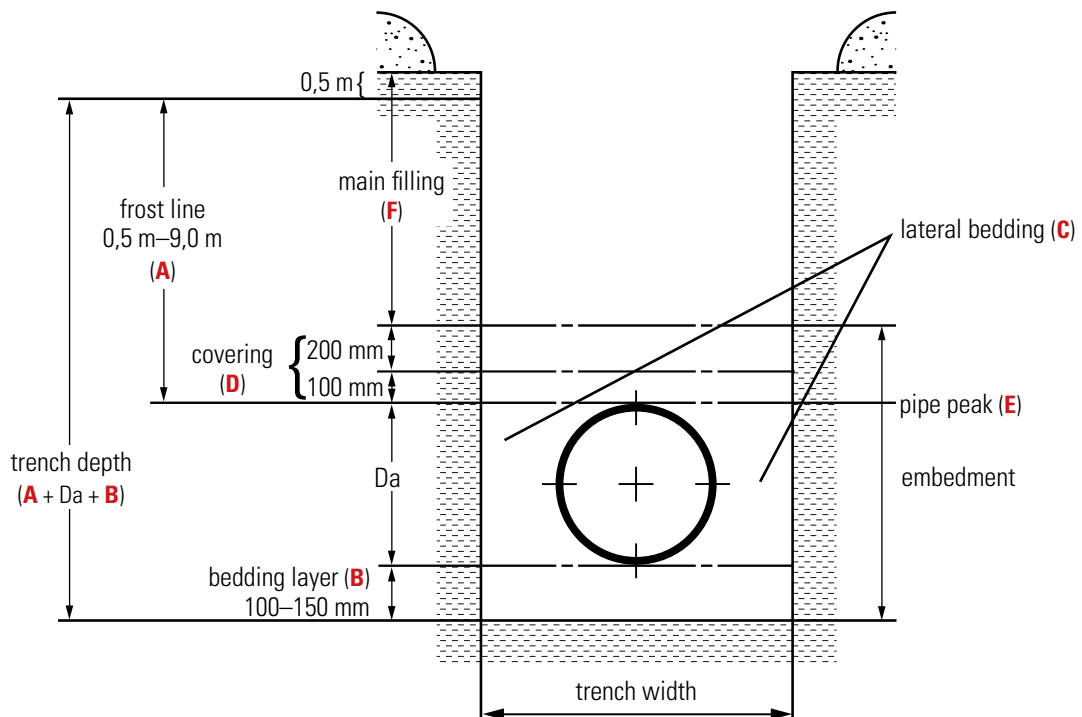

aquatherm ti MORE INFORMATION

For more information on the aquatherm ti system, please see our aquatherm ti catalogue with the order-no. **E30000**. You can request at our Info-Service on telephone-no. **+49 2722 950-0** or download in the download area of our website **www.aquatherm.de**.

aquatherm lilac pipe

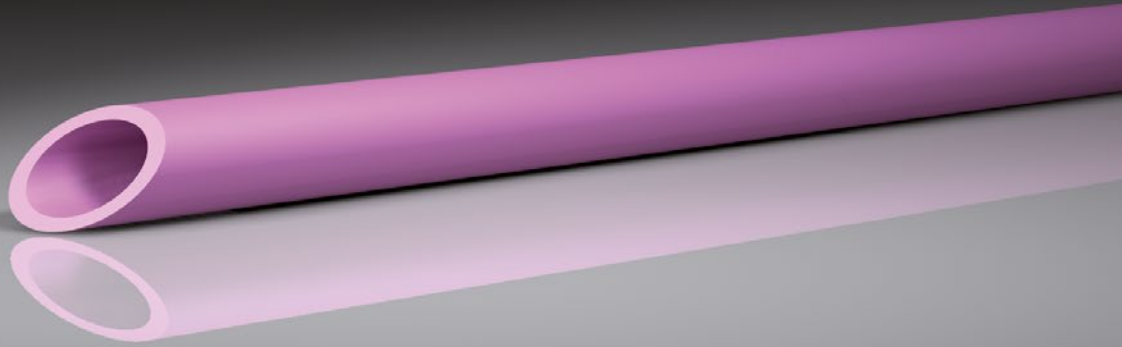

aquatherm lilac pipe

aquatherm lilac pipe was developed exclusively for the field of water recycling. In countries that are highly committed to the environment, like Australia and California, it is already standard to reduce daily water consumption by using recycled water when possible. Now lilac is also regarded in other countries as a standard colour for greywater pipes.

For technical, commercial, agricultural or domestic applications, cost-effective process water is often required. In the private sector, water recycling-systems are increasingly used. Thanks to the long-lasting and corrosion-resistant material Polypropylene, the aquatherm lilac pipe is ideally suited for process water (grey/rainwater).

System components

The system has to be installed in combination with the aquatherm green pipe fittings – and includes all elements for the pipe system installation for rainwater application and irrigation.

The aquatherm lilac pipe system is applied in all fields of

- **NEW INSTALLATION**
- **REPAIR** and
- **RENOVATION.**

Rainwater application

Irrigation

Agriculture

Fields of application



PERMISSIBLE WORKING PRESSURE – POTABLE WATER

Fluid transported: water acc. to DIN 2000

Temperature	Years of service	aquatherm green pipe SDR 11 S aquatherm lilac pipe SDR 11 S		aquatherm green pipe SDR 7,4 S		aquatherm green pipe SDR 6 S		aquatherm green pipe SDR 7,4 MF		aquatherm green pipe SDR 9 MF RP	
		Permissible working pressure in bar and (psi)									
		bar	(psi)	bar	(psi)	bar	(psi)	bar	(psi)	bar	(psi)
20 °C 68 °F	1	15,0	(218)	23,8	(345)	30,0	(435)	28,6	(415)	25,0	(363)
	5	14,1	(205)	22,3	(323)	28,1	(408)	26,8	(389)	24,2	(351)
	10	13,7	(199)	21,7	(315)	27,3	(396)	26,1	(379)	23,9	(347)
	25	13,3	(193)	21,1	(306)	26,5	(384)	25,3	(367)	23,5	(341)
	50	12,9	(187)	20,4	(296)	25,7	(373)	24,5	(355)	23,1	(335)
30 °C 86 °F	1	12,8	(186)	20,2	(293)	25,5	(370)	24,3	(352)	21,7	(315)
	5	12,0	(174)	19,0	(276)	23,9	(347)	22,8	(331)	21,0	(305)
	10	11,6	(168)	18,3	(265)	23,1	(335)	22,0	(319)	20,6	(299)
	25	11,2	(162)	17,7	(257)	22,3	(323)	21,3	(309)	20,2	(293)
	50	10,9	(158)	17,3	(251)	21,8	(316)	20,7	(300)	20,0	(290)
Potable water (cold) Potable water (warm)	40 °C 104 °F	1	17,1	(248)	21,5	(312)	20,5	(297)	18,7	(271)	
		5	16,0	(232)	20,2	(293)	19,2	(278)	18,0	(261)	
		10	15,6	(226)	19,6	(284)	18,7	(271)	17,7	(257)	
		25	15,0	(218)	18,8	(273)	18,0	(261)	17,4	(252)	
		50	14,5	(210)	18,3	(265)	17,5	(254)	17,0	(247)	
	50 °C 122 °F	1	14,5	(210)	18,3	(265)	17,5	(254)	15,9	(231)	
		5	13,5	(196)	17,0	(247)	16,2	(235)	15,3	(222)	
		10	13,1	(190)	16,5	(239)	15,7	(228)	15,1	(219)	
		25	12,6	(183)	15,9	(231)	15,2	(220)	14,8	(215)	
		50	12,2	(177)	15,4	(223)	14,7	(213)	14,5	(210)	
	60 °C 140 °F	1	12,2	(177)	15,4	(223)	14,7	(213)	13,5	(196)	
		5	11,4	(165)	14,3	(207)	13,7	(199)	13,0	(189)	
		10	11,0	(160)	13,8	(200)	13,2	(191)	12,8	(186)	
		25	10,5	(152)	13,3	(193)	12,6	(183)	12,5	(181)	
		50	10,1	(146)	12,7	(184)	12,1	(175)	12,3	(178)	
	65 °C 149 °F	1	11,6	(168)	14,6	(212)	13,9	(202)	12,4	(180)	
		5	10,8	(157)	13,6	(197)	12,9	(187)	11,9	(173)	
		10	10,4	(151)	13,1	(190)	12,5	(181)	11,7	(170)	
		25	10,0	(145)	12,6	(183)	12,0	(174)	11,4	(165)	
		50	8,8	(128)	11,1	(161)	10,6	(154)	11,2	(162)	
70 °C 158 °F	1	10,3	(149)	13,0	(189)	12,4	(180)	11,4	(165)		
	5	9,5	(138)	11,9	(173)	11,4	(165)	10,9	(158)		
	10	9,3	(135)	11,7	(170)	11,1	(161)	10,7	(155)		
	25	8,0	(116)	10,1	(146)	9,6	(139)	10,5	(152)		
	30	7,0	(102)	8,8	(128)	9,3	(135)	10,3	(149)		
50	6,7	(97)	8,5	(123)	8,1	(117)	10,2	(148)			

Faser composite pipe: high working stress at lower wall thickness and higher flow rate

SDR = Standard Dimension Ratio (diameter/wall thickness ratio)

S = single layer

MF = multilayer faser

MF RP = multilayer faser – raised pressure (resistance)

The determination of the allowable pressures resulted from the specific conditions to which pipe system components in the drinking water domestic installation are exposed to.

Limiting factors such as increased flow rates, the use of disinfectants, increased content of oxygen, etc. were considered by the use of the appropriate safety factors.

For fittings of butt-welded pipe segments a reduction factor of 0.75 (reduction of the table values by 25 %) is effective.

PERMISSIBLE WORKING PRESSURE

For heating systems or closed systems considering the seasonal periods of operation – non potable water application

Heating period	Temperature	Years of service	aquatherm blue pipe SDR 11 MF, OT & S		aquatherm blue pipe SDR 17,6 MF		aquatherm green pipe SDR 7,4 MF		aquatherm green pipe SDR 9 MF RP			
			Permissible working pressure in bar and (psi)									
			bar	(psi)	bar	(psi)	bar	(psi)	bar	(psi)		
constant operating temperature 70 °C / 158 °F incl. 30 days per year at	75 °C 167 °F	5	9,38	(136)	5,38	(78)	14,27	(207)	12,90	(187)		
		10	9,08	(132)	5,21	(76)	13,79	(200)	12,60	(183)		
		25	7,82	(113)	4,48	(65)	11,74	(170)	12,20	(177)		
		45	6,77	(98)	3,89	(56)	10,18	(148)	12,00	(174)		
	80 °C 176 °F	5	8,88	(129)	5,09	(74)	13,50	(196)	11,70	(170)		
		10	8,46	(123)	4,86	(70)	12,80	(186)	11,40	(165)		
		25	7,38	(107)	4,24	(61)	11,14	(162)	11,10	(161)		
	85 °C 185 °F	42,5	6,49	(94)	3,72	(54)	9,79	(142)	10,90	(158)		
		5	8,17	(118)	4,69	(68)	12,42	(180)	10,70	(155)		
		10	7,82	(113)	4,49	(65)	11,87	(172)	10,40	(151)		
		25	6,70	(97)	3,85	(56)	10,14	(147)	10,10	(146)		
	90 °C 194 °F	37,5	6,07	(88)	3,49	(51)	9,18	(133)	10,00	(145)		
		5	7,50	(109)	4,30	(62)	11,39	(165)	9,80	(142)		
		10	7,19	(104)	4,13	(60)	10,94	(159)	9,50	(138)		
		25	5,85	(85)	3,36	(49)	8,86	(129)	9,20	(133)		
	constant operating temperature 70 °C / 158 °F incl. 60 days per year at	75 °C 167 °F	35	5,39	(78)	3,09	(45)	8,16	(118)	9,10	(132)	
5			9,26	(134)	5,31	(77)	14,11	(205)	12,30	(178)		
10			8,90	(129)	5,11	(74)	13,57	(197)	12,10	(175)		
25			7,62	(111)	4,37	(63)	11,58	(168)	11,70	(170)		
80 °C 176 °F		45	6,60	(96)	3,79	(55)	10,05	(146)	11,50	(167)		
		5	8,61	(125)	4,94	(72)	13,12	(190)	11,40	(165)		
		10	8,24	(120)	4,73	(69)	12,54	(182)	11,20	(162)		
		25	6,93	(101)	3,98	(58)	10,56	(153)	10,80	(157)		
85 °C 185 °F		40	6,18	(90)	3,55	(51)	9,41	(136)	10,70	(155)		
		5	7,91	(115)	4,54	(66)	12,03	(174)	10,40	(151)		
		10	7,56	(110)	4,34	(63)	11,52	(167)	10,20	(148)		
		25	6,05	(88)	3,47	(50)	9,22	(134)	9,90	(144)		
90 °C 194 °F		35	5,57	(81)	3,20	(46)	8,48	(123)	9,80	(142)		
		5	7,25	(105)	4,16	(60)	11,04	(160)	9,50	(138)		
		10	6,40	(93)	3,67	(53)	9,76	(142)	9,30	(135)		
		25	5,12	(74)	2,94	(43)	7,81	(113)	9,10	(132)		
constant operating temperature 70 °C / 158 °F incl. 90 days per year at	75 °C 167 °F	30	4,90	(71)	2,81	(41)	7,46	(108)	9,00	(131)		
		5	9,17	(133)	5,26	(76)	14,02	(203)	12,20	(177)		
		10	8,79	(127)	5,04	(73)	13,38	(194)	12,00	(174)		
		25	7,45	(108)	4,27	(62)	11,33	(164)	11,60	(168)		
	80 °C 176 °F	45	6,45	(94)	3,70	(54)	9,82	(142)	11,40	(165)		
		5	8,46	(123)	4,85	(70)	12,90	(187)	11,30	(164)		
		10	8,11	(118)	4,65	(67)	12,35	(179)	11,00	(160)		
		25	6,60	(96)	3,78	(55)	10,05	(146)	10,70	(155)		
	85 °C 185 °F	37,5	5,98	(87)	3,43	(50)	9,09	(132)	10,60	(154)		
		5	7,76	(113)	4,45	(65)	11,81	(171)	10,30	(149)		
		10	7,03	(102)	4,04	(59)	10,72	(155)	10,10	(146)		
		25	5,63	(82)	3,23	(47)	8,58	(124)	9,80	(142)		
	90 °C 194 °F	32,5	5,28	(77)	3,03	(44)	8,03	(116)	9,70	(141)		
		5	6,96	(101)	3,99	(58)	10,59	(154)	9,40	(136)		
		10	5,88	(85)	3,37	(49)	8,96	(130)	9,20	(133)		
		25	4,70	(68)	2,70	(39)	7,17	(104)	8,90	(129)		

* SDR = Standard Dimension Ratio (diameter / wall thickness ratio)

SDR = 2 x S + 1 ≈ d/s (S = Pipe series index from ISO 4065)

PERMISSIBLE WORKING PRESSURE

for general pressure pipe applications in permanent operation

charted application ranges on page 25 and 26

Temperature	Years of service	aquatherm blue pipe SDR 17,6 MF		aquatherm blue pipe SDR 11 MF & MF OT aquatherm lilac pipe SDR 11 S		aquatherm green pipe SDR 7,4 MF		aquatherm green pipe SDR 9 MF RP			
		Permissible working pressure in bar and (psi)									
		bar	(psi)	bar	(psi)	bar	(psi)	bar	(psi)		
10 °C 50 °F	1	12,8	(186)	27,8	(403)	30,2	(438)	28,8	(418)		
	5	12,0	(174)	26,2	(380)	28,2	(409)	27,9	(405)		
	10	11,7	(170)	25,6	(371)	27,7	(402)	27,5	(399)		
	25	11,4	(165)	24,7	(358)	26,9	(390)	27,1	(393)		
	50	11,1	(161)	24,1	(350)	26,1	(379)	26,7	(387)		
	100	10,8	(157)	23,5	(341)	25,2	(366)	26,3	(381)		
15 °C 59 °F	1	11,8	(171)	25,7	(373)	29,4	(426)	26,9	(390)		
	5	11,1	(161)	24,2	(351)	27,4	(397)	26,0	(377)		
	10	10,8	(157)	23,6	(342)	26,9	(390)	25,7	(373)		
	25	10,5	(152)	22,8	(331)	26,1	(379)	25,2	(366)		
	50	10,2	(148)	22,2	(322)	25,3	(367)	24,9	(361)		
	100	9,9	(144)	21,6	(313)	24,5	(355)	24,5	(355)		
20 °C 68 °F	1	10,9	(158)	23,8	(345)	28,6	(415)	25,0	(363)		
	5	10,3	(149)	22,3	(323)	26,8	(389)	24,2	(351)		
	10	10,0	(145)	21,7	(315)	26,1	(379)	23,9	(347)		
	25	9,6	(139)	21,0	(305)	25,3	(367)	23,5	(341)		
	50	9,4	(136)	20,4	(296)	24,5	(355)	23,1	(335)		
	100	9,1	(132)	19,9	(289)	23,7	(344)	22,8	(331)		
30 °C 86 °F	1	9,3	(135)	20,2	(293)	24,3	(352)	21,7	(315)		
	5	8,7	(126)	18,9	(274)	22,8	(331)	20,9	(303)		
	10	8,5	(123)	18,4	(267)	22,0	(319)	20,6	(299)		
	25	8,2	(119)	17,8	(258)	21,3	(309)	20,2	(293)		
	50	7,9	(115)	17,3	(251)	20,7	(300)	19,9	(289)		
	100	7,7	(112)	16,8	(244)	20,0	(290)	19,7	(286)		
40 °C 104 °F	1	7,9	(115)	17,1	(248)	20,5	(297)	18,6	(270)		
	5	7,4	(107)	16,0	(232)	19,2	(278)	18,0	(261)		
	10	7,2	(104)	15,6	(226)	18,7	(271)	17,7	(257)		
	25	6,9	(100)	15,0	(218)	18,0	(261)	17,3	(251)		
	50	6,7	(97)	14,6	(212)	17,5	(254)	17,1	(248)		
	100	6,5	(94)	14,1	(205)	16,8	(244)	16,8	(244)		
50 °C 122 °F	1	6,7	(97)	14,5	(210)	17,5	(254)	15,9	(231)		
	5	6,2	(90)	13,5	(196)	16,2	(235)	15,3	(222)		
	10	6,0	(87)	13,1	(190)	15,7	(228)	15,1	(219)		
	25	5,8	(84)	12,6	(183)	15,2	(220)	14,7	(213)		
	50	5,6	(81)	12,2	(177)	14,7	(213)	14,5	(210)		
	100	5,5	(80)	11,9	(173)	14,1	(205)	14,3	(207)		
60 °C 140 °F	1	5,6	(81)	12,2	(177)	14,7	(213)	13,5	(196)		
	5	5,2	(75)	11,4	(165)	13,7	(199)	13,0	(189)		
	10	5,1	(74)	11,0	(160)	13,2	(191)	12,7	(184)		
	25	4,9	(71)	10,6	(154)	12,6	(183)	12,4	(180)		
	50	4,7	(68)	10,3	(149)	12,1	(175)	12,2	(177)		
	100	4,7	(68)	10,3	(149)	12,4	(180)	11,3	(164)		
70 °C 158 °F	1	4,7	(68)	10,3	(149)	12,4	(180)	11,3	(164)		
	5	4,4	(64)	9,6	(139)	11,4	(165)	10,9	(158)		
	10	4,2	(61)	9,2	(133)	11,1	(161)	10,7	(155)		
	25	3,7	(54)	8,0	(116)	9,6	(139)	10,4	(151)		
	50	3,1	(45)	6,8	(99)	8,1	(117)	10,2	(148)		
	100	4,3	(62)	9,4	(136)	11,7	(170)	10,4	(151)		
75 °C 167 °F	1	4,3	(62)	9,4	(136)	11,7	(170)	10,4	(151)		
	5	4,0	(58)	8,7	(126)	10,8	(157)	9,9	(144)		
	10	3,7	(54)	8,0	(116)	10,0	(145)	9,7	(141)		
	25	3,0	(44)	6,4	(93)	8,0	(116)	9,5	(138)		
	50	2,5	(36)	5,4	(78)	6,7	(97)	9,3	(135)		
	100	4,0	(58)	8,6	(125)	10,4	(151)	9,5	(138)		
80 °C 176 °F	1	4,0	(58)	8,6	(125)	10,4	(151)	9,5	(138)		
	5	3,5	(51)	7,7	(112)	9,2	(133)	9,0	(131)		
	10	3,0	(44)	6,5	(94)	7,8	(113)	8,9	(129)		
	25	2,4	(35)	5,2	(75)	6,2	(90)	8,6	(125)		
	50	3,3	(48)	7,2	(104)	8,7	(126)	7,8	(113)		
	100	2,3	(33)	5,1	(74)	6,0	(87)	7,4	(107)		
90 °C 194 °F	1	2,3	(33)	5,1	(74)	6,0	(87)	7,4	(107)		
	10	2,0	(29)	4,3	(62)	5,1	(74)	7,3	(106)		

SDR = Standard Dimension Ratio (diameter/wall thickness ratio)
 S = single layer
 MF = multilayer faser
 MF RP = multilayer faser – raised pressure (resistance)

For fittings of butt-welded pipe segments a reduction factor of 0.75 (reduction of the table values by 25 %) is effective.

aquatherm green pipe

Pipe system made of polypropylene
for potable water supply

SDR: 6
ø: 16–110 mm

Type of pipe:
aquatherm green pipe S

SDR: 7.4
ø: 16–63 mm

Type of pipe:
aquatherm green pipe S

SDR: 11
ø: 20–450 mm

Type of pipe:
aquatherm green pipe S SDR 11

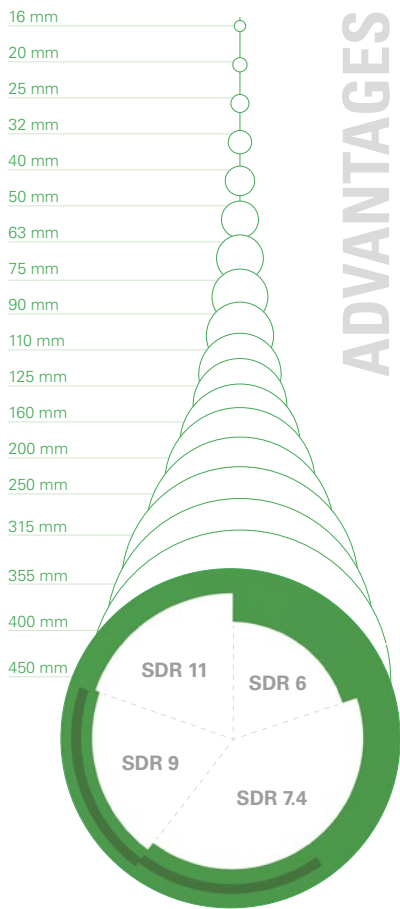

ADVANTAGES

Characteristic

aquatherm PP-R-pipe systems stopping corrosion damages. All materials are corrosion resistant and – compared to metallic pipes – have less noise flow rate. aquatherm PP-R-pipes are opaque – no danger of algae development.

Installation

aquatherm offers an unique and unrivalled connection process: material union by fusion. Shortest connection times are convincing:

e.g. outside diameter 20 mm = 8 sec.

aquatherm pipe connections can be hydraulic pressure tested or put into operation directly after their fusion. There are no extended waiting times.

Quality

This is reflected in national and international certificates, but above all in the satisfaction of aquatherm clients, installers and planners. For more details regarding quality and certificates see page 41.

Composite Technology

aquatherm developed a manufacturing method, realizing the integration of a special faser mixture within the material polypropylene.

The result of this innovative technology is the singular compound of the different materials.

- The linear expansion is reduced by at least 75 % compared with standard PP-pipes
- The flow rate is increased by 20 % due to smaller wall thickness
- High stability
- The coefficient of linear expansion is nearly identical to that of metal pipes, so that compared with usual plastic pipes the support intervals can be enlarged and the number of clamps can be reduced
- Optimum cost-performance ratio
- Lower weight
- High impact rate
- Simply cut and weld

aquatherm blue pipe

Pipe system made of polypropylene
for chilled, hot fluid and various industrial applications

SDR: 11
ø: 20–32mm

Type of pipe:
aquatherm blue pipe S

SDR: 7.4 / 11 / 17.6
ø: 20–630 mm

Type of pipe:
aquatherm blue pipe MF

SDR: 7.4 / 11
ø: 20–250 mm

Type of pipe:
aquatherm blue pipe MF OT



SDR: 7.4 / 9
ø: 20–355 mm

Type of pipe:
aquatherm green pipe MF

SDR: 7.4 / 9
ø: 20–355 mm

Type of pipe:
aquatherm green pipe MF UV

SDR: 9
ø: 32–315 mm

Type of pipe:
aquatherm green pipe MF TI



Advantages PP-RP

- Lower wall-thickness
- 14 % higher flow rate at same velocity compared to faser composite pipe SDR 7.4
- The permissible working pressures are on the same level like those of PP-R-faser composite pipes SDR 7.4 or are even exceeding them in the higher temperature range
- Identical expansion as faser pipe SDR 7.4
- 16 % lower weight than faser composite pipe PP-R SDR 7.4
- Lower weight than stainless steel, steel and copper pipes, thereby easier handling for transport and at site
- Quicker processing by shorter butt-welding times
- Trouble-free welding with all aquatherm PP-R-fittings

Guarantee

As a statement to aquatherm quality standards the aquatherm PP-R-pipe systems carries a 10 year guarantee for pipe and fittings with a product liability of 20 Mio. EUR per damage event.

Price

aquatherm PP-R-pipe systems are perfected pipe systems of high quality material with an optimum cost-performance ratio.

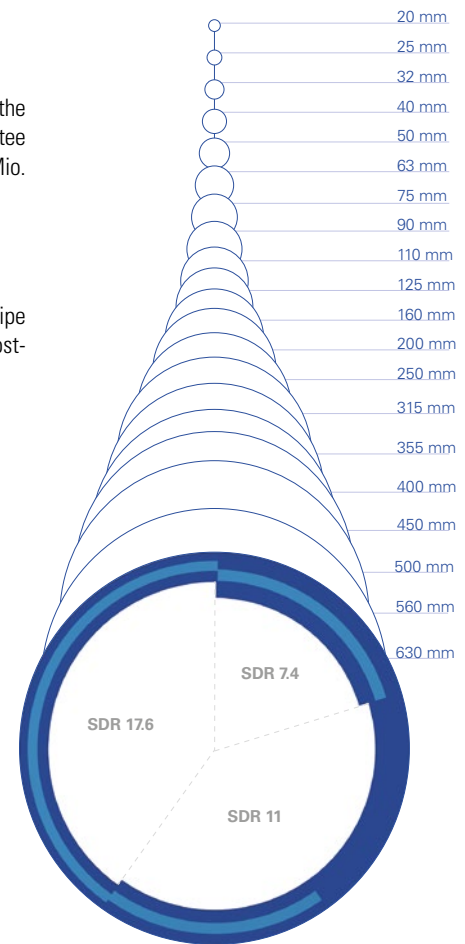

SDR: 7.4 / 11 / 17.6
ø: 20–630 mm

Type of pipe:
aquatherm blue pipe MF UV

SDR: 7.4 / 11 / 17.6
ø: 32–315 mm

Type of pipe:
aquatherm blue pipe MF TI

aquatherm lilac pipe

Pipe system made of polypropylene for reclaimed water

SDR: 7.4 / 11
ø: 20–125 mm

Type of pipe:
aquatherm lilac pipe S





The advantages

of aquatherm pipes and fusiolen® PP-R:

- Absolutely corrosion resistant
- Resistant against chemicals
- High environmental compatibility
- High impact rate
- Less pipe roughness
- Heat and soundinsulating characteristics
- Very good welding properties
- High heat-stabilized
- Noticeable less insulation – recommended are 10 mm of insulation for all pipe dimensions
- High stability
- Lighter in weight
- Easy processing
- Well-priced
- Installation aids and fixings

fusiolen®

OUR MATERIAL FUSIOLEN PP-R

Decades of experience in the production and the application of PP-R-pipe systems and the current ambition of continuous development led to numerous improvements of the aquatherm system technology.

Newly opened markets set a high standard of quality to make even larger demands against the pipe material. Various fields of application require the greatest possible independence of the material to be processed. Raw materials with new properties are required. aquatherm has developed and produced their own, innovative PP-R-materials which meet the requirement of a global market in the potable water and heating technology, in the airconditioning and chilling engineering, in the industrial and agriculture economy, in shipbuilding as well as in fire protection. Successful results of this research are fusiolen® PP-R, fusiolen® PP-R C or fusiolen® PP-R FS.

All aquatherm PP-R-pipes and fittings are made of fusiolen® PP-R.

Special heat and extraction stability are only two of the features of this material. Its physical and chemical properties are well-suited to the transfer of potable water and to the heating field. Above all, the good welding properties and fusion, resulting in a permanent connection, have made the aquatherm systems and the raw material fusiolen® PP-R well known worldwide.

Environment

The environmentally friendly material polypropylene fusiolen® PP-R is recyclable and can be ground, melted and reutilised for various applications e.g. motor-protections, wheel linings, laundry baskets and other kinds of transport boxes. There are no polluting substances with PP-R either in its processing or in its disposal.

fusiolen® PP-R – for the benefit of our environment!

Use of metal deactivators

By adding suitable food-approved additives the risk of amaterial damage caused by metal under extreme conditions of application is substantially reduced.

Higher long-term heat stabilization

The long-term heat stabilization has been increased to resist to the potential effects of peak temperatures within higher safety parameters.

MATERIAL PROPERTIES

Potable water is one of the most controlled commodity goods. The domestic supply system should influence the water on its way up to the taps as less as possible. The choice of the right potable water pipe system and its material is of decisive importance.

aquatherm green pipe systems are suitable for all different qualities of potable water. The environmentally friendly and hygienically enhanced potable water pipe system made from fusiolen® is physiologically and microbiologically harmless. The technical suitability of the aquatherm pipe systems has been evident worldwide for decades.

The extrapolated service life of aquatherm PP-R-pipes is more than 50 years. Peak temperatures of 100 °C arising from short disruptions are unproblematic. Permanent temperatures from 70°C up to 90 °C reduce the service life of the pipe (see table “Permissible Working Pressure”, page 25–27).

Using aquatherm PP-R-pipes for heating or air conditioning applications the pressure- and temperature conditions according to table “Permissible Working Pressure” are valid. The following table shows the operating conditions related to pressure and temperature as a basis for pipe and pipe connections. These figures refer to potable water installations based on a theoretical service life of 50 years.

	Working pressure bar (psi)	Temperature °C	Annual working hours h/a
Cold water	0 up to 10 (145) transient	to 25 (77) *	8760
Hot water	0 up to 10 (145) transient	to 60 (140) to 85 (185)	8710 50

* Reference temperature for the creep rupture strength: 20 °C (68 °F)

HYGIENIC SUITABILITY

According to DIN 1988 T2 all installation parts coming directly in contact with potable water are commodity goods acc. to the Law for Food and Commodity Goods. Plastic pipes have to comply with the KTW-recommendations of the Federal Public Health Department.

Certificates

Numerous international certificates testify to the high quality standard of the green pipes.

- DVGW, SKZ, HIG** (Germany)
- AENOR** (Spain)
- ÖVGW** (Austria)
- WRAS** (UK)
- SAI-Global** (Australia)
- CSTB, CARSO** (France)
- SII** (Israel)
- TIN** (Poland)
- SITAC, KIWA, SWEDCERT** (Sweden)
- IIP** (Italy)
- BNQ** (Canada)
- BRANZ** (New Zealand)
- CERTIF** (Portugal)
- EMI** (Hungary)
- a.m.m.**



Material:

The hygienic suitability of the material used for the aquatherm green pipe system is independently verified through test certificates from the Hygienic Institute in Gelsenkirchen. The suitability for potable water pipes in the field of cold and hot water is confirmed by current tests.

Processing:

The joining method requires no additives such as fluxes or solder. The connection is made by socket fusion.

Potable water – our most precious commodity good:

The increasing use of PP in the field of foodpacking confirms the hygienic qualities of the material. This makes aquatherm green pipe the optimal packing for our most precious commodity goods – potable water.

SOUND INSULATION

The sound insulation qualities of the PP-R-pipe system, related to water flow and hydraulic shock within a building, provide a sound proofing effect on noise transmission. Therefore the sound transmission is much lower compared to metallic pipes.

AQUATHERM & ECOLOGY

Environmental protection is very important to aquatherm.

Products, such as the aquatherm green pipe system are characterized not only by their long service life, but also by their excellent environmental compatibility. Since its foundation, aquatherm attaches great importance to the fact that its products and manufacturing processes do not pollute our sensitive ecosystems. Through the development of fully recyclable materials, it is possible that these can easily be fed into new productions.

Long before environmental protection was recognised as a global issue aquatherm fulfilled ecological standards which are demanded today. For now 40 years aquatherm has underlined its philosophy that ecological and economic interests are not contradictory, neither during production and sales, nor in the product application.

The environmentally friendly raw material fusiolen® is used for the manufacture of the aquatherm pipe systems. To ensure its environmental compatibility the basic material polypropylene, as well as all contained additives (colour pigments and stabilizers) were extensively tested, not only by aquatherm's own laboratory, but also by independent laboratories. Their results show that the material fusiolen® and the pipe systems from which it is manufactured, comply with the highest ecological standards and are thus future-oriented.

TECHNICAL DATA SHEET

Technical properties	fusiolen PP-R (80)	fusiolen PP-R (80) faserpipe
Melt-flow index 190°C/5 kg	0.5 g/10 min.	0.5 g/10 min.
Melt-flow index 230°C/2.16 kg	0.3 g/10 min.	0.3 g/10 min.
Modulus of elasticity	800 N/mm ²	1200 N/mm ²
Yield stress	25 N/mm ²	30 N/mm ²
Density	0.9 g/cm ³	1.0 g/cm ³
Tensile strength	25 MPa	35 MPa
Inflammation temperature	430 °C – 450 °C	490 °C – 500 °C
Thermal expansion coefficient	1.5 *10 ⁻⁴ K ⁻¹	0.35 *10 ⁻⁴ K ⁻¹
Coefficient of thermal conduction	0,15 W/mK (measured at pipe)	0,15 W/mK (measured at pipe)
Coefficient of friction in pipes	0.007	0.007
Bending radius	6 x d	
Water absorption	< 0.02 %	< 0.02 %
Electrical properties	fusiolen PP-R (80)	fusiolen PP-R (80) Faser
Relative permittivity	2,3 (in case of 1 MHz)	2,3 (in case of 1 MHz)
Puncture voltage	500 kV/cm	500 kV/cm
Specific resistance	> 10 ¹⁷ Ω cm	> 10 ¹⁷ Ω cm
Surface resistance	10 ¹⁴ Ω	10 ¹⁴ Ω
Dissipation coefficient	0.0002 (in case of 50 Hertz)	0.0002 (in case of 50 Hertz)

ENVIRONMENTAL PRODUCT DECLARATION AND LEED CERTIFICATION

As the world’s first pipe system manufacturer, aquatherm has developed an Environmental Product Declaration (EPD) for its products. Thus the aquatherm products contribute to the attainment of points in the LEED system. Learn more about the importance of life cycle assessments, environmental product declarations and LEED for planners, engineers and builders.

Life-Cycle Assessments (LCAs)

LCAs provide a comprehensive evaluation of the upstream and downstream energy and environmental impacts associated with a product. They are comprised of five parts: Goal, Scope, Life-Cycle Inventory Analysis, Results, and Interpretation. aquatherm has chosen the cradle-to-gate approach for its LCA „Life Cycle of Polypropylene Pressure Piping Systems“ encompassing the product life cycle from the extraction of raw materials through manufacturing and product distribution.

Environmental Product Declarations (EPDs)

The EPD is the document used to convey the LCA’s results to the products’ users and specifiers. It focuses on information about a product’s environmental impact such as global warming, ozone depletion, water pollution, ozone creation, and greenhouse gas emissions.

EPDs typically are verified following the processes described in ISO 14025, EN 15804, and ISO 21930 for construction products. These steps include: 1) Finding or developing a Product Category Rule (PCR); 2) Generating the input data and performing an LCA according to a specific PCR; 3) Compiling information in the EPD; 4) Verification of the EPD and LCA; and 5) Registration and publication.

aquatherm utilized ThinkStep as independent third party to conduct an ISO-conformant LCA for its following product lines: green pipe, blue pipe, lilac pipe, red pipe and the black system for radiant heating and cooling, and red pipe. In the study, one meter (3.2 ft) length of pipe was selected as functional unit per the requirements of the respective PCR “Piping Systems for Use for Sewage and Storm Water (Under Gravity)”. The declared product was defined as a representative average of the five aquatherm product offerings.

Two different test methodologies were chosen to analyze the products in the LCA: Tool for Reduction and Assessment of Chemical and Other Environmental Impacts (TRACI) 2.1 and CML 2001, a method developed by the Institute of Environmental Sciences at the University of Leiden in the Netherlands. The TRACI 2.1 method utilized impact categories, including Global Warming Potential (GWP), Acidification Potential (AP), Eutrophication Potential (EP), Ozone Depletion Potential (ODP), and Smog Formation Potential (SFP). The results of the findings are summarized in the following table.

Environmental impacts and Primary Energy Demand of aquatherm PP-R piping systems according to TRACI 2.1

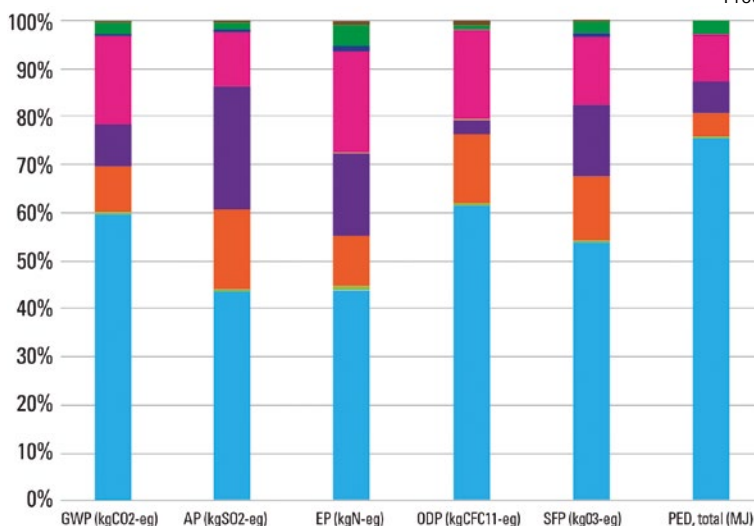

Upon completion of the aquatherm product-specific LCA, aquatherm submitted its products, the LCA, and supporting documentation for independent verification by NSF International. The verification process included a review by an independent panel of experts, an audit of the manufacturing facilities and records, and a confirmation of material formulations. aquatherm’s Product-Specific Type III third-party verified EPD was published Dec. 18, 2015: <http://info.nsf.org/Certified/Sustain/ProdCert/EPD10069.pdf>

Within the EPD, you will find information on aquatherm, its product descriptions, data quality requirements, raw-materials origins, a manufacturing diagram, a declaration of parameters per the PCR, and the lifecycle-impact conclusion for aquatherm pipe.

Advantages of PP-R piping systems and radiant panels compared to metal systems

The analysis has shown that polypropylene comprises nearly 50% or more of the impact contribution depending on the impact category. Also Primary Energy Demand (PED) is mainly driven by polypropylene. However, this is because of the embodied energy content of the resin rather than fuel consumption upstream. In other words, aquatherm polypropylene has available energy within the material that can be recovered later in the product’s life cycle during recycling. This differs greatly compared with metals. With metal systems, all of the energy is used in the original processing of the raw material. Metals do not provide energy to the recycling process.

Thus aquatherm PP-R piping systems and radiant panels can provide a more sustainable, lower environmental impact option to designers, engineers, and building owners when compared with other piping and radiant panel systems.

How is aquatherm’s EPD relevant to LEED v4 points?

LEED stands for „Leadership in Energy and Environmental Design“ and is one of the most popular green building certification programs used worldwide. It was developed by the U.S. Green Building Council (USGBC) in 1998 and has defined various standards for environmentally friendly, resource-saving and sustainable construction.

LEED v4 incorporates point structures to encourage the use of products/ materials that environmentally, economically, and socially support preferable life-cycle impacts. Point structures were developed to reward the selection of products from manufacturers who have verified improved environmental life-cycle impacts.

aquatherm’s green pipe, blue pipe, lilac pipe, red pipe and black system products have attained Type III EPD status through independent verification by NSF International. They now can be utilized as a portion of the 20 permanent products engineers must have throughout their LEED-certified buildings. aquatherm’s EPD also carries double the weight of the Industry-Wide (Generic) EPD in terms of LEED product value and four times the weight of a self-certified Product-Specific Declaration by a manufacturer.

aquatherm has continued its industry leadership position by becoming the first piping manufacturer to have an independently verified, Product-Specific Type III EPD and by supporting building owner to achieve LEED certification.

For further information please see our White Paper: http://www.aquatherm-pipesystems.com/fileadmin/template/img/4.%20Service/PDF/aquatherm_LEEDv4_english.pdf

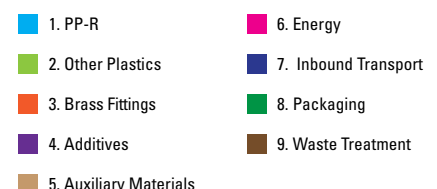

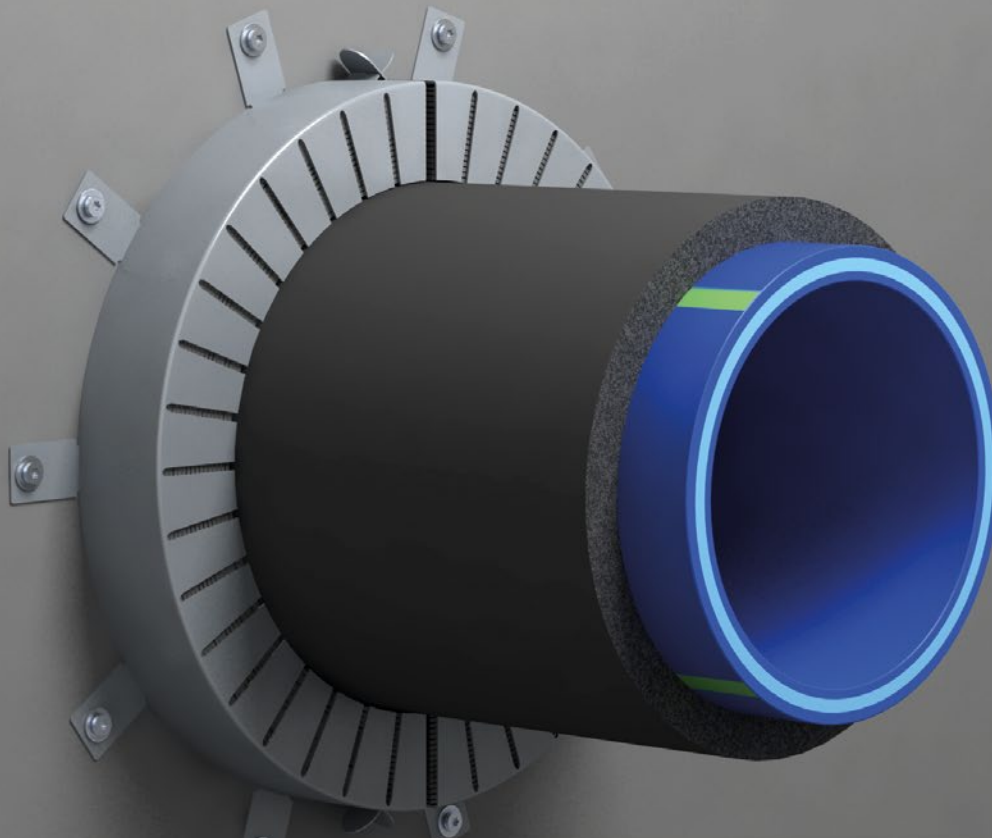

FIRE PROTECTION

The aquatherm PP-R-pipe systems comply with the requirements of the fire classification B2 DIN 4102 (normal inflammable). Compared to natural products like wood, cork or wool, aquatherm PP-R-pipes do not produce any gas toxicity. In case of fire, there is no risk of dioxin emissions.

To avoid fire and smoke transmission aquatherm advises the use of fire retardant seals. The fire resistance period is the minimum period in minutes.

The extent of the preventive measures depends on the type of installation. The determining of fire areas and fire classification has to be made in accordance with the law of the country. Information is given by the Planning Department and Building Control Office or the Fire Protection Representative.

Basically fire walls and ceilings with pipe passages have to be installed to the same fire resistance classification. All fire protection systems with a corresponding classification are suitable for aquatherm PP-R pipes.

The following companies offer suitable fire protection solutions:

Fire protection pipe shell Conlit 150 U:

DEUTSCHE ROCKWOOL GmbH & Co. KG

Rockwool Straße 37-41
45966 Gladbeck, Germany
Phone: +49 2043 408-0 · Fax: +49 2043 408-444
www.rockwool.de

Fire protection sleeve AWM II:

b.i.o. BRANDSCHUTZ GmbH

Oberwaldstraße 3a
64859 Eppertshausen, Germany
Phone: +49 6071 390070
www.bio-brandschutz.de

Hilti Deutschland AG

Hiltistrasse 2
86916 Kaufering, Germany
Phone: +49 800 888 55 22
www.hilti.de

Application of the fire protection sleeve AWM II in the wall

Application of the fire protection sleeve AWM II in the ceiling

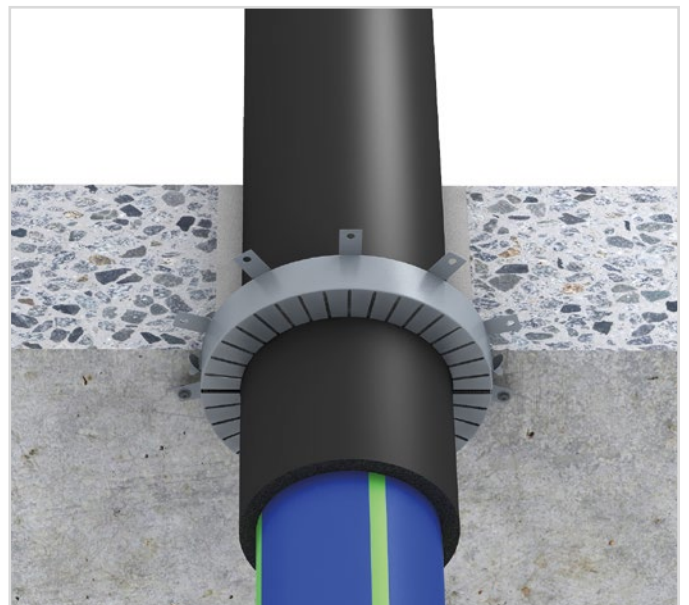
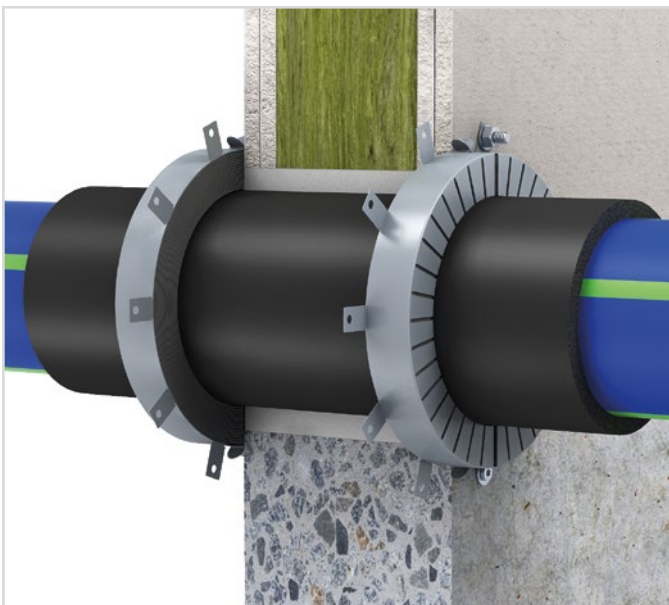
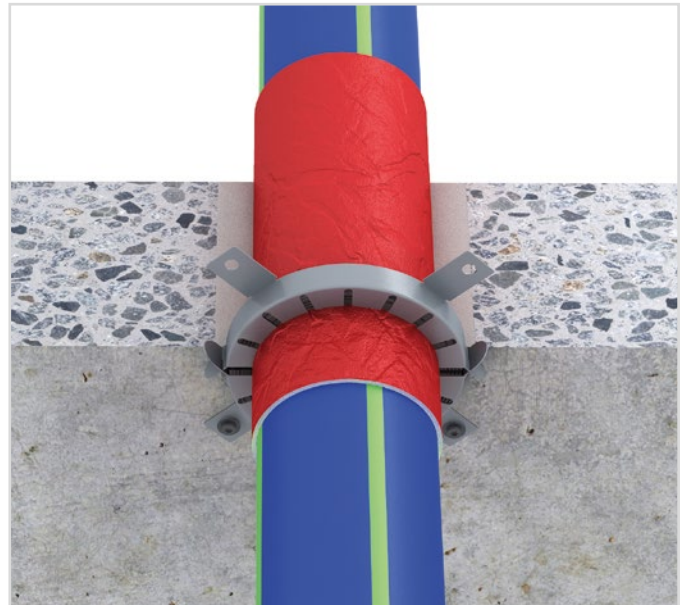
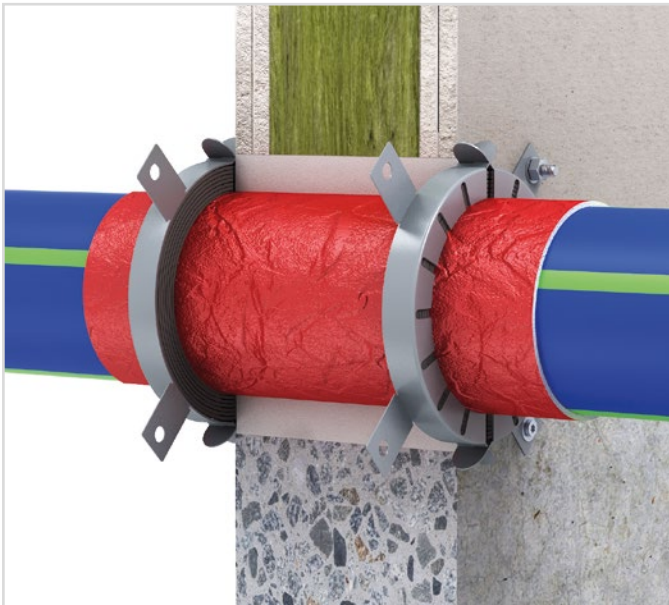
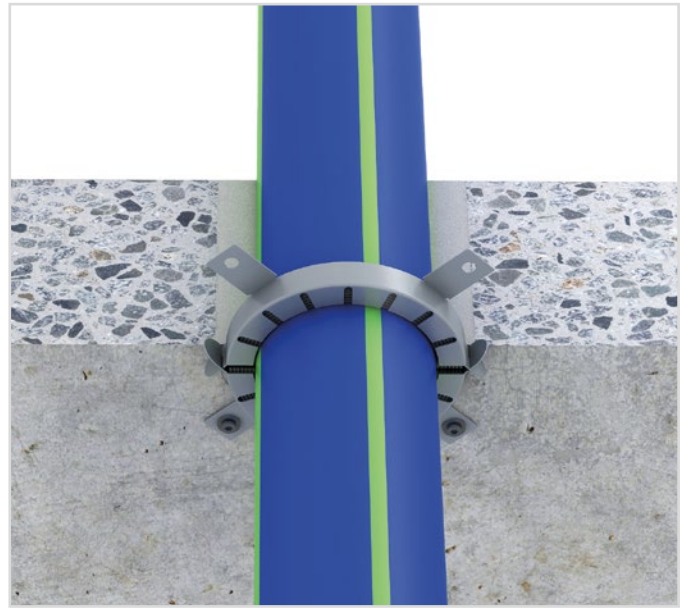

EXCERPT FROM THE ROCKWOOL PLANNING AND INSTALLATION AID

R 30- to R 90 pipe penetrations for the aquatherm installation systems with non-combustible media, such as drinking water, heating, cooling

Product name / Material

aquatherm green pipe/ PP-R
SDR 7,4 MF, SDR 9 MF RP,
SDR 6 S, SDR 7,4 S, SDR 11 S

aquatherm blue pipe /PP-R
SDR 7,4 MF, SDR 11 MF,
SDR 11 S

aquatherm lilac pipe/ PP-R
SDR 7,4 S, SDR 11 S

aquatherm red pipe/ PP-R/B1
SDR 7,4 MF

aquatherm grey pipe/ PE-Xc/Al/PE-X
Multi-layer composite pipe

aquatherm grey pipe/ PB

aquatherm black system PP grid pipe
oxygen-tight

aquatherm orange system/PE-RT

aquatherm green pipe
SDR 7,4 MF UV,
SDR 9 MF RP UV,
SDR 7,4 MS

aquatherm blue pipe
SDR 7,4 MF OT,
SDR 11 MF OT,
SDR 7,1 MF UV,
SDR 11 MF UV

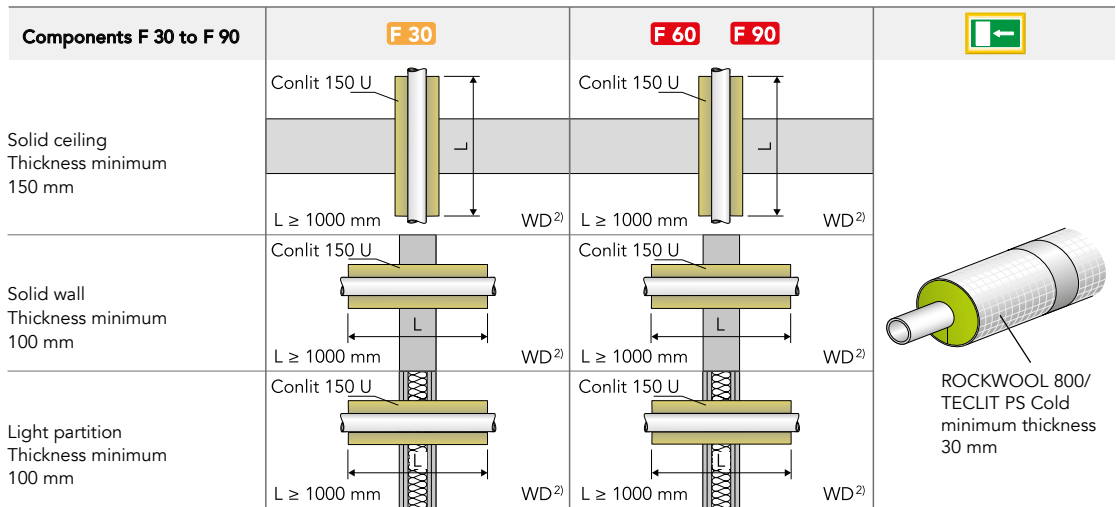

Variant according to Variant according to ROCKWOOL abP P-3726/4140-MPA BS.

System	Pipe dimension	Conclit 150 U			ROCKWOOL 800 ^{1), 2), 3)} TECLIT PS Cold ^{1), 2), 3)}			
		Outer diameter Da [mm]	Type ³⁾	Insulation thickness ⁴⁾ s [mm]	Core drilling Dk [mm]	EnEV 100 % hot, type	EnEV 50 % hot, type	DIN 1988 cold, type ³⁾
aquatherm green pipe aquatherm blue pipe aquatherm lilac pipe aquatherm red pipe aquatherm grey pipe	14,0	12/24	24,0	60	15/20	15/20	15/20	
	16,0	16/22	22,0	60	18/20	18/20	18/20	
	17,0	17/21,5	21,5	60	18/20	18/20	18/20	
	20,0	20/20	20,0	60	22/20	22/20	22/20	
	25,0	25/17,5	17,5	60	28/20	28/20	28/20	
	26,0	26/17	17,0	60	28/20	28/20	28/20	
	32,0	32/24	24,0	80	35/30	35/20	35/30	
	40,0	40/20	20,0	80	42/40	42/20	42/40	
	50,0	50/25	25,0	100	54/40	54/30	54/40	
	63,0	63/33,5	33,5	130	64/50	64/30	64/50	
aquatherm black system PP aquatherm orange system PE-RT	75,0	75/52,5	52,5	180	76/70	76/40	76/70	
	90,0	90/65	65,0	220	102/80	102/40	102/80	
	110,0	110/70	70,0	250	114/100	114/50	114/100	
	aquatherm green pipe UV + MS aquatherm blue pipe OT + UV	16,0	18/21	21,0	60	18/20	18/20	18/20
		20,0	22/19	19,0	60	22/20	22/20	22/20
		25,0	27/16,5	16,5	60	28/20	28/20	28/20
		32,0	34/23	23,0	80	35/30	35/20	35/30
40,0		42/19	19,0	80	42/40	42/20	42/40	
50,0		52/24	24,0	100	54/40	54/30	54/40	
63,0		65/57,5	57,5	180	76/50	76/30	76/50	
75,0	77/51,5	51,5	180	89/70	89/40	89/70		
90,0	90/65	65,0	220	102/80	102/40	102/80		
110,0	113/53,5	53,5	220	114/100	114/50	114/100		

Notes/special installation conditions

- ¹⁾ In some cases, the available minimum insulation thickness is specified.
- ²⁾ For further insulation, the insulation ROCKWOOL 800 or TECLIT PS Cold can be used.
- ³⁾ For cold pipes, a vapor barrier must be available according to DIN 1988-200, therefore only use fire protection pipe shell Conclit 150U/ Insulating shell ROCKWOOL 800 or TECLIT PS Cold.
- ⁴⁾ Insulation thickness according to EnEV 50% and according to DIN 1988 - 200 suitable for the core bore diameter DK.

All basic conditions of the specified general building inspectorate test certificates must be considered.

FIRE LOAD

The values required for determining the fire load within a fire section are calculated from the total of all flammable materials located within this area. The calculation for establishing the combustion heat V [kWh/m] for a fire section in the event of an outbreak is dependent on dimensions and materials.

The basis used for the calculation of pipes made of PP-R is the lower calorific value

$H_u = 12.2$ kWh/kg (as per DIN V 18230 T1) in conjunction with the mass of material m_{pipe} [kg/m].

The integrated layers of faser in aquatherm faser-composite pipes also are considered.

Depending on the calculation procedure, the fire load is worked out with reference to the burn-up factor. This value is designated as m_{factor} and is taken as 0.8 for polypropylene.

Fire protection for aquatherm PP-R-pipes

The latest pipe supply regulation draft determines the professional wall and ceiling duct and also the pipe insulation of escape and rescue routes. The required pipe-insulation stipulated in this draft can be easily achieved by the aquatherm PP-R-pipes.

Combustion values V [kWh/m] for aquatherm green pipe, aquatherm blue pipe and aquatherm lilac pipe

Dimension mm	aquatherm green pipe & aquatherm lilac pipe SDR 11 S	aquatherm green pipe SDR 7.4 S	aquatherm green pipe SDR 6 S	aquatherm green pipe SDR 9 MF RP	aquatherm green pipe SDR 7.4 MF & aquatherm blue pipe SDR 7.4 MF SDR 7.4 MF OT	aquatherm green pipe SDR 11 MF & aquatherm blue pipe SDR 11 MF SDR 11 MF OT	aquatherm blue pipe SDR 17.6 MF
16	-	1,17	1,5	-	-	-	-
20	1,32	1,82	2,12	-	1,76	-	-
25	2,01	2,83	3,27	-	2,74	-	-
32	3,18	4,54	5,33	3,12	4,39	3,14	-
40	5,05	7,05	8,24	5,69	-	4,83	-
50	7,82	10,99	12,77	8,80	-	7,48	-
63	12,35	17,28	20,26	14,03	-	11,82	-
75	17,21	24,58	28,68	19,71	-	16,48	-
90	24,92	35,21	41,22	28,41	-	23,86	-
110	36,89	52,68	61,45	42,17	-	35,33	-
125	47,91	-	-	54,38	-	45,83	32,91
160	78,28	-	-	88,90	-	74,88	48,53
200	121,89	-	-	139,00	-	116,64	75,68
250	189,59	-	-	216,18	-	181,42	117,64
315	313,54	-	-	343,66	-	285,82	186,32
355	381,86	-	-	436,33	-	362,93	236,07
400	505,08	-	-	-	-	460,78	299,73
450	639,28	-	-	-	-	583,21	378,64
500	-	-	-	-	-	-	468,24
560	-	-	-	-	-	-	584,88
630	-	-	-	-	-	-	740,59

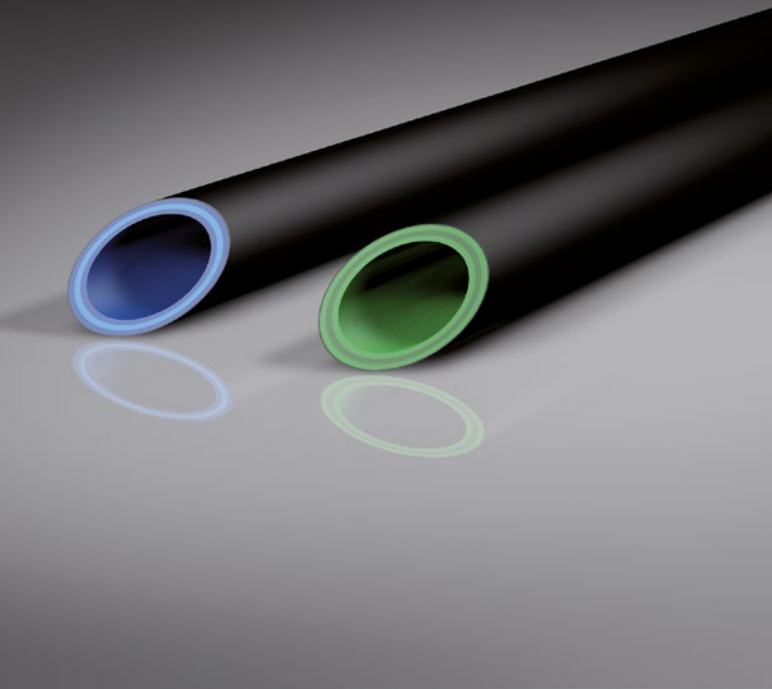

UV-RESISTANCE

Pipes made from fusiolen® PP-R and fusiolen® PP-R C are normally not installed where subject to UV-radiation. All aquatherm PP-R-pipes and -fittings have UV-stabilizer to bridge transport and installation times. Maximum storage time in the open air is 6 months.

For the application in open air aquatherm offers composite pipes with UV-protective layer made from polyethylene, which excludes damages caused by sunlight.

aquatherm PP-R-pipes with UV-protection are always available in stock.

Available types of pipe:

- aquatherm green pipe MF**
- aquatherm blue pipe MF**

UV ADHESIVE TAPE

As an alternative to our pipes, factory-equipped with UV protective layer, the wrapping with UV tape is possible, e.g. when fittings or short pieces of pipe must be protected. Therefore an elastic tape with good resistance to abrasion, moisture, oils, mild acids and alkalis and outdoor weather influences should be selected. The tape should always be applied to a dry, clean and grease-free surface. The winding should be performed with slight pulling and at least 50 % overlap.

Further information on page 120.

CHEMICAL AND THERMAL DISINFECTION

of aquatherm drinking water systems made of polypropylene

a) Chemical disinfection of the system

Contrary to the disinfection of drinking water, the disinfection of a system is a discontinuous measure, comprising a drinking water system from the area of contamination to the tapping point of the consumer. In general, a disinfection is to be applied temporarily only in case of a proven contamination.

In case of **discontinuous** disinfections, it is allowed to load aquatherm pipes and the corresponding fittings twice a year with a content of free chlorine of 50 mg/l for not more than 12 hours.

Alternatively, 150 mg/l hydrogen peroxide (H₂O₂) can be used for 24 hours. A temperature of 30 °C must not be exceeded during the disinfection process. The use of a disinfection process, especially with chlorinated waters can have a direct influence on the lifetime of the drinking water system. Under no circumstances should chlorine dioxide be used.

b) Chemical disinfection of drinking water

In case of **continuous** disinfection with chlorinated drinking water, it can be used with a content of free chlorine of up to 0.3 mg/l (limit according to 2001 drinking water ordinance). The maximum temperature of 70 °C should not be exceeded.

Unless required by local regulations, residual disinfection is not necessary where there is no evidence of bacterial water contamination.

Under no circumstances should chlorine dioxide be used.

Recommendation of the World Health Organization – Guidelines for Drinking-water Quality, Fourth Edition

For effective disinfection, there should be a residual concentration of free chlorine of ≥ 0.5 mg/l after at least 30 min contact time at pH < 8.0. A chlorine residual should be maintained throughout the distribution system. At the point of delivery, the minimum residual concentration of free chlorine should be 0.2 mg/l.

c) Thermal disinfection of the system

In general, a thermal disinfection according to DVGW W551 is possible. In case of the thermal disinfection for the prevention of legionella bacteria according to DVGW worksheet W 551, the water temperature will be adjusted in such a way that it amounts to 70 °C for at least 3 minutes at all points of the drinking water system. The maximum admissible limits of use regarding the service temperature and pressure are to be observed.

INTEGRATION OF OTHER SYSTEMS OR COMPONENTS WITH AQUATHERM PIPING FOR PRESSURE PIPE APPLICATIONS

When integrating aquatherm piping systems with other systems or components not made of PP-R (e.g. components not made of PP-R like valves, pumps, other piping, check valves, strainers, etc), care must be taken to ensure the operating parameters for PP-R won't damage the other materials or vice versa.

Be aware that even if the aquatherm pipe is compatible with the fluid being transported, other materials in the system may not be. All parts of the system must be verified as compatible with the medium being carried before installing them. And, while aquatherm pipe does not require treatment to protect it from corrosion, metals (ferrous and non-ferrous) in the system may be susceptible to corrosion.

Do not mix aquatherm pipe with other piping systems in conditions that will cause the other system or components to fail.

DOMESTIC HOT WATER RECIRCULATION (DHWR)

A hot water circulation system includes all components that are in contact with the circulating water, including the flow and return supply. When there is copper piping used in conjunction with PP-R in a DHWR system, care should be taken to ensure the operating conditions will not cause degradation or erosion/corrosion of the copper. aquatherm recommends following the Copper Development Association guidelines (CDA Publication A4015-14/16: The Copper Tube Handbook – www.copper.org) for sizing, temperature and flow velocity in copper tubing. This will also help ensure that the copper levels in the water do not approach the regulatory action levels recommended by independent institutions (e.g. U.S. Environmental Protection Agency (EPA), World Health Organization (WHO), Federal Ministry of Justice and Consumer Protection of Germany). Sustained high levels of copper in DHWR piping can damage components within the system, even PP-R. **Damage caused by copper in the water resulting from erosion/corrosion or other degradation of copper components in the DHWR system will void the aquatherm warranty.**

Accordingly, and as mandated by various regulations and codes in DHWR systems, it is considered good design and operational practice to ensure that the maximum HW-temperature within any part of the system / loop does not exceed 60 °C (140 °F). Some regulations and codes further restrict the temperature at any fixture to a maximum of 50 °C (120 °F). There are some exceptions to this such as the process of thermal disinfection in health care facilities where temperatures of 70 °C (160 °F) or higher can be applied for short periods of time throughout the pipe system.

Importantly, the maximum temperature used must not exceed the rating of the pipe for the operating pressure. (See aquatherm green pipe catalogue – table: permissible working pressure potable/drinking water – Fluid transported: water acc. to DIN 2000)

According to some regulations and codes, flow rates in a DHWR system should not exceed 0.5 m/s (1.5 ft/sec) anywhere in the system, except in some special cases where velocities up to 1 m/s (3 ft/sec) are needed to achieve proper flow temperature. The CDA Publication A4015-14/16 – The Copper Tube Handbook – limits the velocity in DHWR system to similar rates.

When re-piping an existing DHWR-system originally installed in copper tubing, ensure all possible copper is replaced. If some copper remains as part of the system, strictly follow the rules and guidelines of the Copper Development Association (CDA Publication A4015-14/16: The Copper Tube Handbook) regarding flow rates and water conditions. Small amounts of copper or brass in valves and other equipment will generally not cause an issue. If the copper fails, it may degrade o-rings, gaskets, PP-R and other components as well, shortening their service life.

When adding PP-R to an existing copper system in a DHWR-application, the level of copper in the water should be tested. These levels should not exceed

0.1 mg/L (ppm). Higher levels of total copper indicate that the copper pipe is corroding/eroding due to system and/or water conditions.

To hydraulically balance a DHWR-system and ensure the required flow rate for each area of the building, it is necessary to install hydraulic-balancing-valves in every circulating loop throughout the complete system. This also maintains the flow velocity in the smaller return piping at or below the manufacturer's or CDA's recommendations.

In addition to sizing the piping and pumps to the correct flow velocity, care must also be taken to avoid water hammer and excessive surge pressures. Pump systems operating with on/off cycling, or pumps over-sized for the piping, can create high pressure and fatigue the piping material. The pump total dynamic head (TDH) must also be matched to the flow requirements, piping layout, and operating conditions to avoid cavitation for all components throughout the system. Cavitation can lead to excessive system noise and more importantly, can result in the erosion and degradation of the pipe surface and other components. Properly sized variable-speed (VFD) constant pressure pumping systems and pressure-sustaining valves can alleviate these issues. The pumps should be sized to operate at maximum efficiency with the lowest energy usage for the required flow rate.

The issues described here are only of concern in DHWR-systems. For domestic cold water (DCW) and mechanical (heating-cooling)-systems no additional requirements or actions are necessary. In some situations, the DHWR system is also used to provide hot water to the mechanical heating system. Additional consideration and care must be given for this type of combined system, as the mechanical components may not be compatible with the more aggressive water conditions and flow velocity limitations of DHWR systems, and these components may be not suitable for potable water contact.

QUALITY ASSURANCE

The following laws, decrees, guidelines and standards have to be considered on planning and designing aquatherm PP-R-pipes for potable water and heating installations:*

Planning:

TrinkwV-2000 Regulation for Potable Water

DIN 2000 Central drinking water supply-Guidelines regarding requirements for drinking water, planning, construction, operation and maintenance of plants

EnEV Decree for Energy Saving

DIN 1988 Standard for Potable Water Installations

ISO 10508 Plastic pipe systems for hot and cold water installation – Guideline for classification and dimensioning

All provided pipe-systems correspond to the technical conditions of the application classes acc. to ISO 10508 for the field of potable water and heating.

aquatherm green pipe for the classes 1, 2 (potable water), aquatherm blue pipe for the classes 4 and 5 (heating). For the application of the classification system (acc. to ISO 10508) the national regulations and the manufacturer's instructions must be considered.

DIN 4109 Standard for the Elimination of Noise in the Field of Structural Engineering

DIN 18381 Installation of Gas, Water and VOB Part C Sewage Pipes inside Buildings

DIN 16928 Pipe Connections, Fittings, Installation

DVS 2207 Welding of Thermoplastics

DVS 2208 Welding Machines and Devices for Thermoplastics

aquatherm Technical Information

System-specific standards:

General quality requirements, dimensions

DIN 8077 Polypropylene (PP) Pipes, Dimensions

DIN 8078 Polypropylene (PP) Pipes, General Quality Requirements

DIN 16962ff Pipe Joint Assemblies and Fittings for Polypropylene Pressure Pipes

DIN EN ISO 15874ff Plastic pipe systems for hot and cold water installation; polypropylene

DVGW-Working sheets

SKZ-Guidelines

DIN EN ISO 9000 ff.

System-specific standards: Hygiene

BfR Federal Institute for risk assignment

Health assessment of plastics and non-metallic materials within the framework of the law for foods and commodity goods for potable water applications

DVGW-working sheet W 270

Increase of Microorganism on Materials. Used for Potable Water Applications – Test and Evaluation

BS 6920

“Suitability of non-metallic products for use in contact with water intended for human consumption with regard to their effect on the quality of water.”

Local regulations and codes of practice must be observed. The same goes for regulations regarding the use of chemicals.

*(Additional regional decrees and recommendations are disregarded.)

COMPLIANCE WITH THE SYSTEM STANDARD

Various national and international independent authorities and institutions confirm aquatherm's quality standard



AQUATHERM QUALITY MANAGEMENT SYSTEM

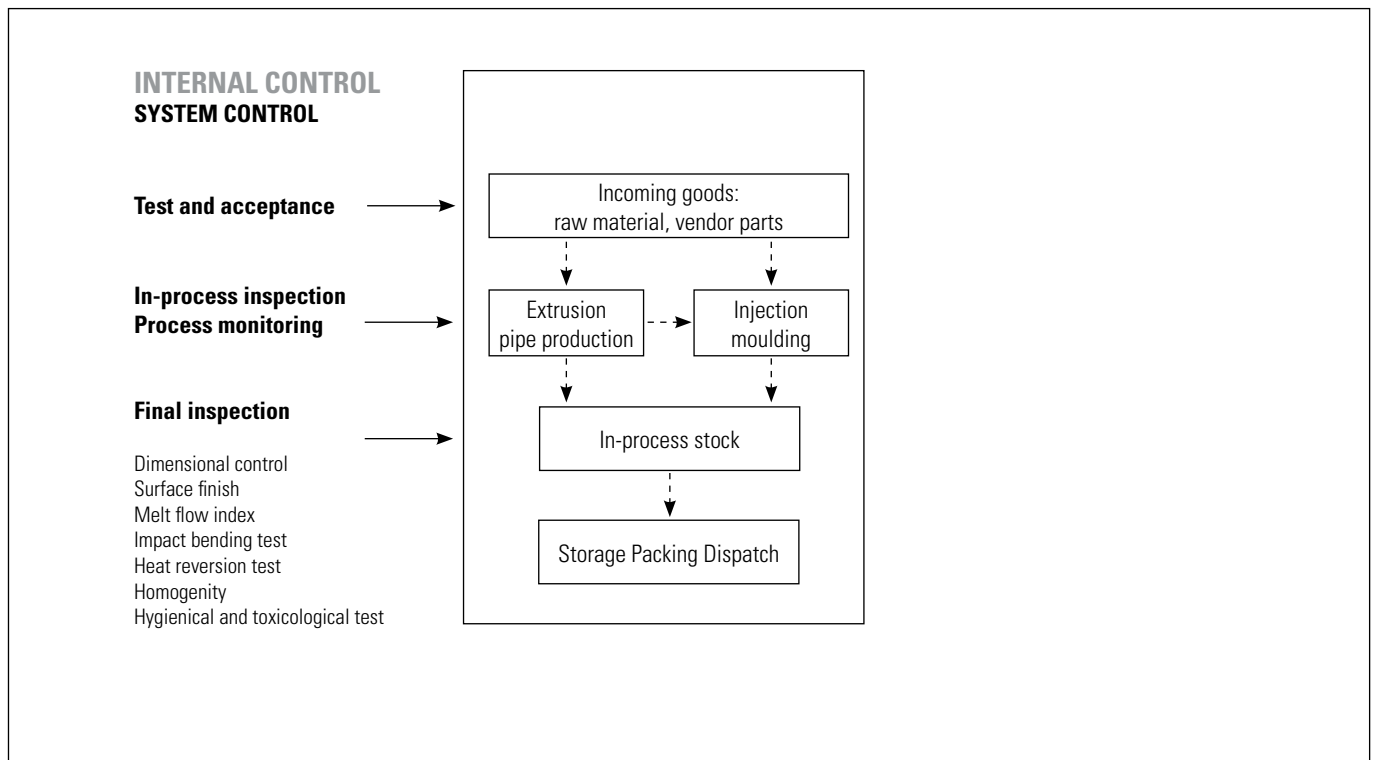

In addition to the permanent internal quality control, an external control is made by i.e. SKZ, SAI, TGM, Hygieneinstitut.



SYSTEM CONTROL

The production of a quality controlled pipe system demands the supervision, regulation and control of all work operations. All results and processes have to be documented.

This requires

- Test and acceptance of incoming goods
- Process control
- In-process inspection and test
- Final inspection and test

Relevant regulations for the quality control of potable water pipe systems are:

- DIN-guidelines
- DVGW-working sheets
- Supervisory Regulations of the SKZ (Süddeutsches Kunststoff-Zentrum)

These standards and guidelines detail the minimum requirements for internal control.

Conformance to the standards is verified by independent institutes in form of internal audits and laboratory tests.

aquatherm has many years of experience in extrusion and injection moulding and is the market leader and pioneer in the manufacture of polypropylene pipe systems.

This experience is reflected in internal quality standards and laid down procedures, which are taken strongest note of and are documented by the constant quality of our products.

Internal control

Trained and qualified employees and a modern equipped laboratory ensure that all tests are carried out and regulations are complied with in accordance with the quality control policy, which includes

- Control of inspection, measuring and test equipment process and Production control
- Receiving inspection test
- In-process inspection
- Final inspection

All internal quality controls are documented and recorded in accordance with the quality control policy.



QUALITY ASSURANCE

Test and acceptance of incoming goods

All incoming goods are subject to a test. This ensures that incoming products conform to specified requirements. Goods, which have not been tested are not released for production.

In-process inspection and test

The quality plan requires that tests and inspections are carried out before and during production. At the start of production all quality relevant data are checked by the quality assurance department. Preproduction samples are tested by the laboratory technicians for

- Surface finish
- Dimensional accuracy of the test samples
- Data from extrusion and injection moulding machines

and whether they meet the specifications. Only if this is ensured, it will be released for production. The tests are carried out at the beginning of each series production in order to guarantee impeccable quality.

Process control

Ultrasonic measurement and process data recording in the field of extrusion are only two examples of the extensive quality control process.

This equipment enables constant observation and control of production.

Ultrasonics automatically measure and report any deviations in tolerance to the cutting device on the extrusion machine so that the sizing plant automatically isolates a substandard product. This ensures that only perfect quality products are packed and stored.

All data received during production is analyzed in detail.

Final inspection and test

After completion of the products, all final inspections specified in the test plan are conducted. Only if it has been proven that all the required tests are fully documented and the results correspond to the optimum system quality, the products are sent to the finished goods warehouse.

The final inspection and test covers the following test procedures:

- Dimensional control
- Surface finish
- Measurement of the melt flow index
- Impact bending test
- Heat reversion test
- Homogeneity of the material
- Internal pressure test

In addition to the tests mentioned above, daily hygiene tests in accordance with KTW/DVGW Guidelines are carried out regularly in the company's own sensory analysis laboratory.

DVGW type examination certificate
DVGW-Baumusterprüfzertifikat

Field of Application products of water supply
Anwendungsbereich Produkte der Wasserversorgung

Owner of Certificate aquatherm GmbH
Zertifizierer aquatherm GmbH
Biggen 5, D-57439 Attendorn

Distributor aquatherm GmbH
Vertrieber aquatherm GmbH
Biggen 5, D-57439 Attendorn

Product Category installation systems with special pipes: drinking w
Produktart (8801)

Product Description drinking water system consisting of plastic pipes (p
Produktbeschreibung plastic fittings (PP-R), type S-HK

Model aquatherm green pipe SDR6 S (fusiotherm)

Test Reports laboratory control test: 27516/2, 1/123612 from 02
Prüfberichte laboratory control test: 27616/2, 1/123613 from 06
KTW testing: K-271607-16-Ba/1st from 13.06.2016
hygienic testing: W-274650-15-Si/NI from 25.08.2
KTW testing: K-231614-13-Ba/1st from 02.07.2013
hygienic testing: W-274649-15-Si/NI from 25.08.2
laboratory control test: 27606/2, 2/74867 u. Erg. fr

Test Basis DVGW W 534 (01.05.2004)
Prüfgrundlagen DVGW W 544 (01.05.2007)
USA KTW (07.10.2008)
DVGW W 270 (01.11.2007)

Date of Expiry / File No. 14.02.2022 / 17-0198-WNV
Ablaufdatum / Aktenzeichen

28.04.2017 GI A-1/2
DAKs
Deutscher
Akkreditierungsstelle
D-31 0000-01-01

DVGW CERT GmbH ist eine der DAKs nach DIN EN ISO/IEC 17065:2013
akkreditierte Stelle für die Zertifizierung von Produkten der Energie- und
Wasserversorgung.

ZERTIFIKAT SKZ Süddeutsches Kunststoff-Zentrum

Verleihungs-Urkunde
Das Süddeutsche Kunststoff-Zentrum verleiht der Firma

Aquatherm GmbH
Kunstst.-Extrusions- u. Spritzgießtechnik
Finnentropfer Straße 82
57439 Attendorn

das Recht zum Führen des SKZ-Prüf- und Überwachungszeichens

SKZ WÜRZBURG

A 175
für nachstehende Kunststofforzugnisse

Druckrohre aus PP-R 80
Fertigungsgruppe 1 und 2

Mit der Führung des SKZ-Zeichens ist die Verpflichtung verbunden, die Bestimmungen der Fertigungsgruppe 1 und 2 einzuhalten.

Würzburg, den 9. März 1984

K. Schmidt
Institutsleiter

ZERTIFIKAT SKZ Süddeutsches Kunststoff-Zentrum

Verleihungs-Urkunde
Das Süddeutsche Kunststoff-Zentrum verleiht der Firma

Aquatherm GmbH
Kunstst.-Extrusions- u. Spritzgießtechnik
Finnentropfer Straße 82
57439 Attendorn

das Recht zum Führen des SKZ-Prüf- und Überwachungszeichens

SKZ WÜRZBURG

A 314
für nachstehende Kunststofforzugnisse

Faserverbundrohre aus PP-R 80 / PP-R 80-GF / PP-R 80
Fertigungsgruppe 1 und 2

Mit der Führung des SKZ-Zeichens ist die Verpflichtung verbunden, bei der Herstellung und Prüfung der Erzeugnisse die vorgeschriebenen Bestimmungen einzuhalten.

Würzburg, den 27. Juli 2000

K. Schmidt
Institutsleiter

U. Or. Schmidt
Abteilungsleiter

EXTERNAL CONTROL

External supervision consists of tests of a defined scope and in defined intervals. The respective supervising institutions appoint authorized test organizations to carry out these tests.

The external supervision includes external tests of the products and

- a) internal audit of aquatherm's quality assurance system and test procedures,
- b) calibration of the test equipment and
- c) hygienic and toxicity tests.

The results of the supervisory visits as well as external tests made on pipe and fitting samples are confirmed to aquatherm in test certificates.

In Germany, the external supervision of the aquatherm green pipe system is carried out by the

- SKZ (Süddeutsches Kunststoffzentrum in Würzburg)
- Institute for Hygiene, Gelsenkirchen (Hygieneinstitut in Gelsenkirchen)

who are authorized by the DVGW (German Institute for Gas and Water) as controlling organization. The external supervision for certificates from abroad is carried out in a similar way.

Storage / packing / dispatch

Upon successful release the products are stored in suitable warehouses.

Internal instructions control the method of packing, storage and dispatch of the products. The warehouse staff is responsible for control of the stored product.

FUSION

PART A: ASSEMBLY OF WELDING TOOLS

The professional processing of aquatherm PP-R-medium pipes is made by the following tools for the connection of insulated pipes and fittings by socket welding or by butt-welding.

IMPORTANT!

Only use the original aquatherm welding devices and aquatherm welding tools, except devices and tools which are especially approved by aquatherm.

1. **aquatherm** manual welding device (800 W) without welding tools (Art. no. 50337) for medium pipes of dimension 16–63 mm
2. **aquatherm** manual welding device (1400W) without welding tools (Art. no. 50341) for medium pipes of dimension 50–125 mm
3. **aquatherm** welding tools for manual welding devices

Art. no. 50206	16 mm
Art. no. 50208	20 mm
Art. no. 50210	25 mm
Art. no. 50212	32 mm
Art. no. 50214	40 mm
Art. no. 50216	50 mm
Art. no. 50218	63 mm
Art. no. 50220	75 mm
Art. no. 50222	90 mm
Art. no. 50224	110 mm
Art. no. 50226	125 mm

4. **aquatherm** welding machine (1400W) incl. welding tools 50–125 mm (Art. no. 50148) for medium pipes of dimension 50–125 mm
5. **aquatherm** butt-welding-machines for medium pipes of dimension 160–630 mm
6. **aquatherm** electrical welding jig Art. no. 50159 for medium pipes of dimension 63–125 mm



Manual welding device 800W with welding tools 16–63 mm



Manual welding device 1400W with welding tools 50–125 mm



Welding machine



Butt-welding machine two-ring-machine and accessories



Electrical welding jig

MOUNTING OF THE TOOLS

1. aquatherm green, blue and lilac pipe system are processed identically.

Assemble and tighten the cold welding tools manually.

3. Before fusing the distribution block, in which two connections are fused simultaneously, the welding tools have to be placed into the respective holes as described in the adjoining table A and drawing B.

4. All welding tools must be free from impurities. Check if they are clean before assembling. If necessary clean the welding tools with a non fibrous, coarse tissue and with methylated spirit.

Place the welding tools on the welding device so that there is full surface contact between the welding tool and the heating plate. Welding tools over Ø 40 mm must always be fitted to the rear position of the heating plate.

Electric supply:

The power supply must coincide with the data on the type plate of the welding device and must be protected according to the local regulations. To avoid high power loss, the conductor cross-section of the used extension cables must be selected according to the power input of the welding devices.

6. Plug in the welding device. Depending on the ambient temperature it takes 10–30 minutes to heat up the heating plate.

A

Art. no.	Passage	Hole	Branch	Hole
30115	Ø 25 mm	A + E	Ø 20 mm	A + C
85123	Ø 20 mm	A + B	Ø 16 mm	A + C

B

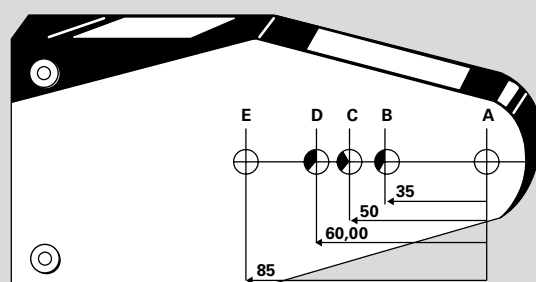

PART A: HEATING UP PHASE / HANDLING

Temperature pilot lamp (yellow)
glows constantly while the heat-up phase and blinks, when the welding temperature is achieved

Operating lamp (green)
glows constantly, as soon as the device is connected with the power supply system

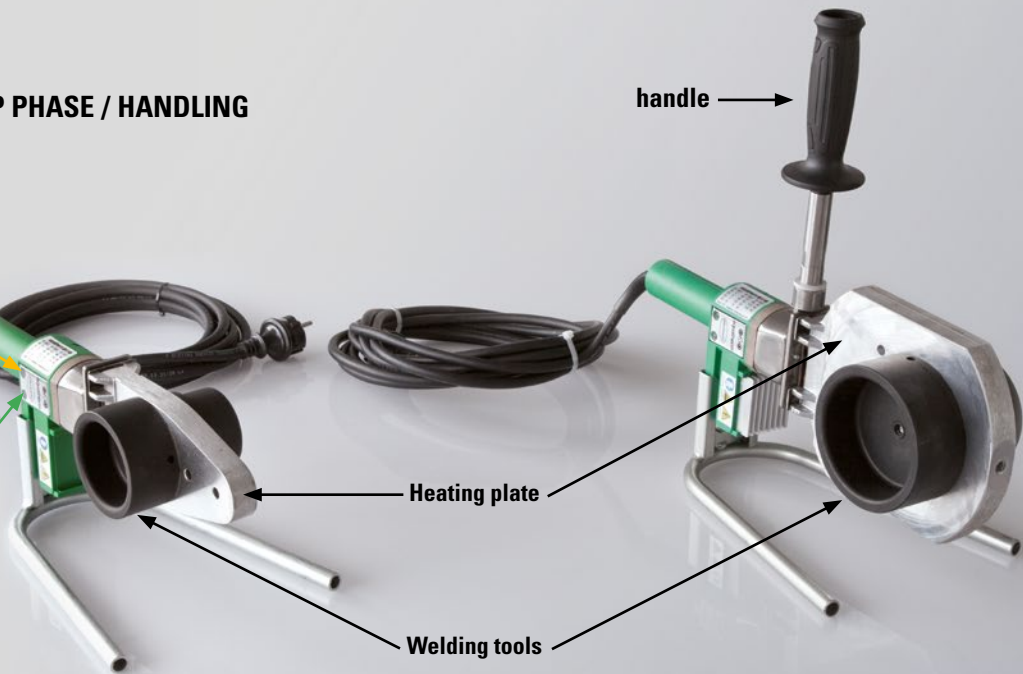

Part A: Heating up phase

- 7. During the heating up phase tighten the welding tools carefully with the Allan key.

Take care that the tools completely contact the heating plate. Never use pliers or any other unsuitable tools, as this will damage the coating of the welding tools.

- 8. The temperature of 260 °C is required for the welding of aquatherm PP-R-pipes.

Acc. to DVS-Welding Guidelines the temperature of the welding device has to be checked at its tool before starting the welding process.

This can be done with a fast indicating surface thermometer.

ATTENTION:

First welding – soonest 5 minutes after reaching of the welding temperature. DVS 2207, Part 11.

Part A: Handling

- 9. A tool change on a heated device requires another check of the welding temperature at the new tool (after its heating up).
- 10. If the device has been unplugged, e.g. during longer breaks, the heating up process, has to be restarted (see item 6).
- 11. After use unplug the welding device and let it cool down. Water must never be used to cool the welding device, as this would destroy the heating resistances.
- 12. Protect aquatherm welding devices and tools against impurities. Burnt particles may lead to an incorrect fusion. The tools may be cleaned with aquatherm cleaning cloths, Art. no.50193.

Always keep the welding tools dry.

- 13. After welding, do not lay the device on the Teflon coated tool, but put it down in the provided supporting stand.
- 14. For a perfect fusion, damaged or dirty welding tools must be replaced, as only impeccable tools guarantee a perfect connection.
- 15. Never attempt to open or repair a defective device. Return the defective device for repair.
- 16. Check the operating temperature of aquatherm welding devices regularly by means of suitable measuring instruments.

PART A: GUIDELINES

PART B: CHECKING OF DEVICES AND TOOLS

Part A: Guidelines

17. For the correct handling of welding machines the following must be observed:

General Regulations for Protection of Labour and Prevention of Accidents and particularly the Regulations of the Employers' Liability Insurance Association of the Chemical Industry regarding Machines for the Processing of Plastics, chapter: „Welding Machines and Welding Equipment“.

18. For the handling of aquatherm welding machines, devices and tools please observe General Regulations DVS 2208 Part 1 of the German Association for Welding Engineering, Registered Society (Deutscher Verband für Schweißtechnik e.V.).

Part B: Checking of devices and tools

1. Check, if the aquatherm welding devices and tools comply with to the guidelines "Fusion Part A".

2. All used devices and tools must have reached the necessary operating temperature of 260 °C. This requires acc. to "Fusion Part A, item 8" a separate test, which is indispensable (DVS-Welding Guidelines):

Suitable measuring instruments have to measure a temperature of up to 350 °C with a high accuracy.

NOTE:

aquatherm recommends the original aquatherm temperature measuring device Art. no. 50188

PART B: PREPARATION FOR THE FUSION

3. Cut the pipe at right angles to the pipe axis. Only use aquatherm pipe cutters or other suitable cutting pliers. Take care that the pipe axis is free from burrs or cutting debris and remove where necessary.

4. Mark the welding depth at the end of the pipe with the enclosed pencil and template.

5. Mark the desired position of the fitting on the pipe and/or fitting. The markings on the fitting and the uninterrupted line on the pipe may be used as a guide.



Measurement of temperature at the aquatherm manual welding device (800W)

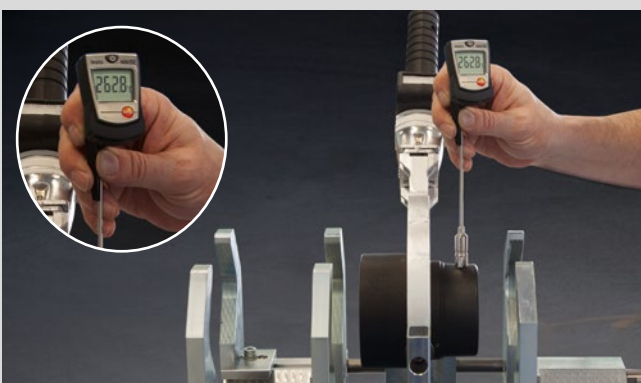

Measurement of temperature at the aquatherm welding machine



Measurement of temperature at the aquatherm butt-welding machine



Cutting of the pipe



Marking of the welding depth

PART B: HEATING OF PIPE AND FITTING

Heating of pipe and fitting

6. Push the end of the pipe, without turning, up to the marked welding depth into the welding tool.

It is essential to observe the aforementioned heating times.

Pipes and fittings of the dimensions \varnothing 75 to 125 mm can only be welded with welding device Art. no. 50341 (or with machine Art. no. 50148). On using the aquatherm welding machine Art. no. 50148 a separate operating instruction has to be observed.

ATTENTION:

The heating time starts, when pipe and fitting have been pushed to the correct welding depth on the welding tool. Not before!

PART B: SETTING AND ALIGNMENT

7. After the required heating time quickly remove pipe and fitting from the welding tools. Joint them immediately, and without turning, until the marked welding depth is covered by the PP-bead from the fitting.

ATTENTION:

Do not push the pipe too far into the fitting, as this would reduce the bore and in an extreme case will close the pipe.

8. The joint elements have to be fixed during the specified assembly time. Use this time to correct the connection. Correction is restricted to the alignment of pipe and fitting. Never turn the elements or align the connection after the processing time.
9. After the required cooling time the fused joint is ready for use.

The result of the fusion of pipe and fitting is a permanent material joining of the system elements. Connection technique with security for a life-time.

The fusion is subject to the following data

Pipe external- \varnothing	Welding depth	Heating time		Welding time	Cooling time
		sec. DVS	sec. AQT*		
mm	mm	sec.	sec.	sec.	min.
20	14,5	5	8	4	2
25	16,0	7	11	4	2
32	18,0	8	12	6	4
40	20,5	12	18	6	4
50	23,5	18	27	6	4
63	27,5	24	36	8	6
75	30,0	30	45	8	8
90	33,0	40	60	8	8
110	37,0	50	75	10	8
125	40,0	60	90	10	8

ATTENTION: sec. AQT* heating times recommended by aquatherm at ambient temperatures below + 5 °C



Heating-up of pipe and fitting



Joining, fixing and...



...aligning



The result: a permanent connection!

Dimension 160–630 mm:

The dimension 160–630 mm are joined by butt-welding.

Detailed information page 66–71.

The General Guidelines for Heated Tool Socket Welding acc. to DVS 2207 Part 11 are applied hereupon.

PART B: UNIVERSAL PEELING TOOLS

By using the aquatherm universal peeling tools the end pieces of the aquatherm OT (oxygen tight) and UV (UV-resistant) can be peeled. By the uniform removal of the outer layer of the pipe any extension of the pipe system by electrofusion socket or fitting is possible. The universal peeling tools are available in the sizes \varnothing 20–125 mm (Art. no. 50479–50488). The peeling process is done either mechanically or manually. For the mechanical processing two attachment plates for pipe sizes \varnothing 20–63 mm (Art. no. 50499) and \varnothing 75–125 mm (Art. no. 50500) are available. For the mechanical processing of the electrofusion sockets the peeler is extended by an attachment (Art. no. 50489–50498). The power drill should have a high torque.

1. INSTRUCTIONS FOR THE MECHANICAL PEELING PROCESS

1.1. The attachment plate is clamped with the hexagon bolt in the power drill.

1.2. The peeler is fixed with its screws in the slot matching the diameter of the attachment plate and rotated clockwise so that the peeler adheres to the attachment plate.

1.3. The peeling tool clamped on the chuck is set by the lead to the end of the pipe.

1.4. The peeling process starts with rotation of the peeling tool upon slight force in axial direction. The peeling operation is completed when the attachment plate strikes against the pipe end.

1.5. The pipe now can be welded by socket welding method.

2. INSTRUCTIONS FOR THE MECHANICAL PEELING PROCESS FOR ELECTROFUSION SOCKETS

2.1. The extension is centered with the peeler through the superimposed chamfer fit and fastened with three Allen screws.

2.2. The attachment plate is clamped with the hexagon bolt in the power drill and connected with the peeling tool (see photo **1.2.**).

2.3. The peeling process starts with rotation of the peeling tool upon slight force in axial direction. The peeling operation is completed when the carrier plate strikes against the pipe end.

2.4. The peeling tool is withdrawn from the pipe and the E-socket welding process can start.

3. PEELING INSTRUCTIONS FOR MANUAL PEELING

3.1. For the manual peeling two handles are mounted at the peeling tool.

3.2. The peeling tool is pushed onto the untreated pipe up to the stop.

3.3. The peeling tool is turned clockwise as long as the marked peeling depth (see table on the next page) is reached.

3.4. If the specified/marked peeling depth (see table) is reached, the peeling tool is removed and the socket welding process can start. If the electric socket can be used as a sliding sleeve, the peeling depth for the electric socket welding (see table) must be doubled.



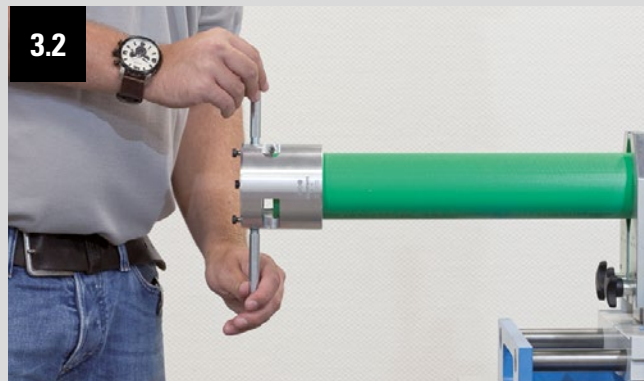
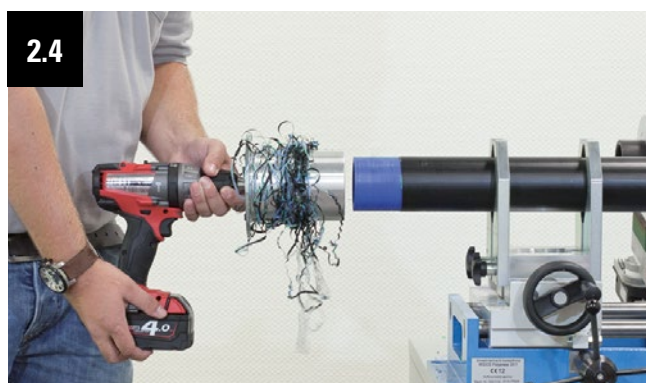
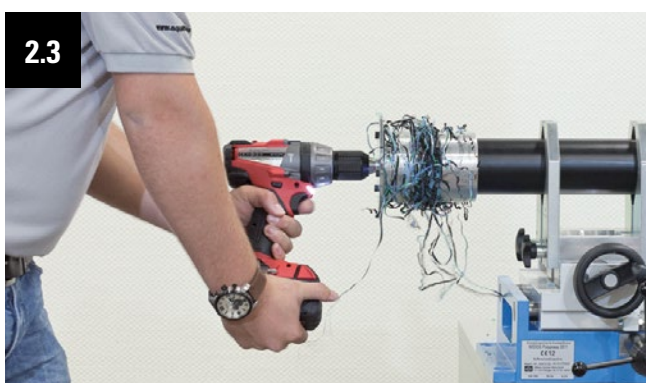
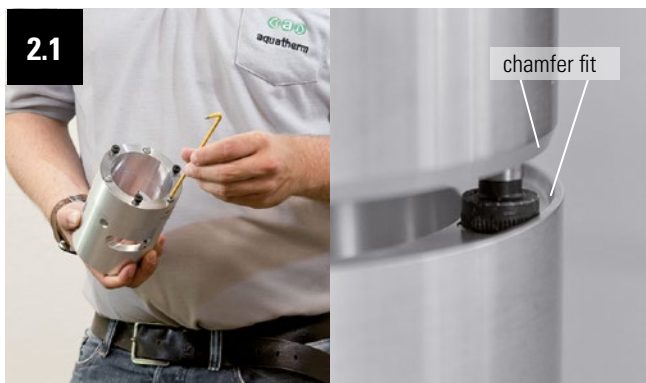

**TABLE OF PEELING DEPTH:
SOCKET AND ELECTRIC SOCKET WELDING**

Diameter	Peeling depth Socket welding	Peeling depth Electric socket welding
ø 20	16 mm	39 mm
ø 25	20 mm	43 mm
ø 32	22 mm	45 mm
ø 40	25 mm	50 mm
ø 50	28 mm	56 mm

Diameter	Peeling depth Socket welding	Peeling depth Electric socket welding
ø 63	32 mm	65 mm
ø 75	34 mm	69 mm
ø 90	37 mm	77 mm
ø 110	42 mm	85 mm
ø 125	44 mm	90 mm

PART C: WELD-IN SADDLES

aquatherm weld-in saddles are available for pipe outer diameter of 40–630 mm.

Weld in saddles are used for

- Branch connections in existing installations
- The substitution of a reduction-tee
- Branch connections in risers
- Sensor wells, etc.

The maximum sensor well diameter is specified in the table on page 55.

1. Before starting the welding process, check whether the aquatherm welding devices and tools comply with the requirements of "Fusion Part A".

2. The first step is to drill through the pipe wall at the intended outlet point by using the aquatherm drill (Art. no. 50940–50958).

3. IMPORTANT!

Only the oxygen barrier layer of the aquatherm blue pipe OT Art. no. 2170708–2170138 must be removed with the mentioned aquatherm special peeling drills mentioned in the table beside.

For this the special peeling drill is inserted into the bore hole and swayed 2–3 times with light pressure and low rotating speed between the pipe walls until the oxygen barrier layer is completely peeled off.

The UV-layer is removed in the same way.

Remove burrs, debris and other dirt with a chamfering tool or the aquatherm cleaning wipes. Do not touch the peeled surface any more and protect it from new pollution.

4. The welding device/saddle welding tool must have reached the required operating temperature of 260 °C (check with reference to "Fusion Part B, item 2").

5. The welding surfaces have to be clean and dry.

6. Insert the heating tool on the concave side of the weld in saddle tool into the hole drilled in the pipe wall until the tool is completely in contact with the outer wall of the pipe. Next the weld-in saddle tool is inserted into the heating sleeve until the saddle surface is up against the convex side of the welding tool. The heating time of the elements is generally 30 seconds.

7. After the welding tool has been removed, the weld-in saddle tool is immediately inserted into the heated, drilled hole. Then the weld-in saddle should be pressed on the pipe for about 15 seconds. After being allowed to cool for 10 minutes the connection can be exposed to its full loading. The appropriate branch pipe is fitted into the sleeve on the aquatherm weld-in saddle using conventional fusion technology.

By fusing the weld-in saddle with the pipe outer surface and the pipe inner wall the connection reaches highest stability.

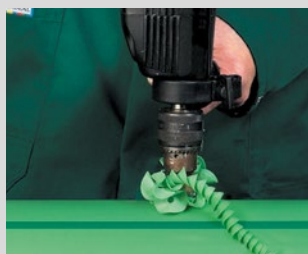

Drilling through the pipe wall



Removal of the oxygen barrier layer in case of the aquatherm blue pipe OT and of the UV layer in case of the aquatherm UV-pipe

aquatherm saddle peeling tools for **aquatherm blue pipe** OT-pipes
aquatherm blue pipe UV-pipes
aquatherm green pipe UV-pipes
ø 50–125 mm

Art. no.	Dimension
50921	for weld-in saddles ø 20 & 25 mm
50922	for weld-in saddles ø 32 mm
50924	for weld-in saddles ø 40 mm
50926	for weld-in saddles ø 50 mm
50928	for weld-in saddles ø 63 mm

aquatherm saddle peeling tools for **aquatherm blue pipe** OT-pipes
aquatherm blue pipe UV-pipes
aquatherm green pipe UV-pipes
ø 160–250 mm

Art. no.	Dimension
50421	for weld-in saddles ø 20 & 25 mm
50422	for weld-in saddles ø 32 mm
50424	for weld-in saddles ø 40 mm
50426	for weld-in saddles ø 50 mm
50428	for weld-in saddles ø 63 mm

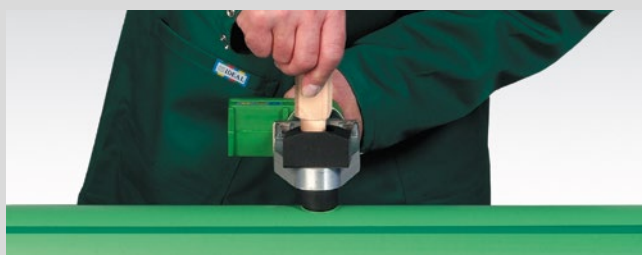

The welding tool is inserted into the pipe wall ...



...heating-up of the elements



Joining



Ready!

PART C: WELD-IN SADDLES

Art. no.	Dimension	D			d		l		Drill		Special peeling drill ¹		Special peeling drill ¹	
		mm	mm	mm	mm	mm	mm	mm	Art. no.	Art. no.	Art. no.	Art. no.	Art. no.	
15156	40/20 mm	40	25	27.0	50940	50921	50614							
15158	40/25 mm	40	25	28.0	50940	50921	50614							
15160	50/20 mm	50	20	27.0	50940	50921	50616							
15162	50/25 mm	50	25	28.0	50940	50921	50616							
15164	63/20 mm	63	20	27.0	50940/50941	50921	50619							
15166	63/25 mm	63	25	28.0	50940/50941	50921	50619							
15168	63/32 mm	63	32	30.0	50942	50922	50620							
15170	75/20 mm	75	20	27.0	50940/50941	50921	50623							
15172	75/25 mm	75	25	28.0	50940/50941	50921	50623							
15174	75/32 mm	75	32	30.0	50942	50922	50624							
15175	75/40 mm	75	40	34.0	50944	50924	50625							
15176	90/20 mm	90	20	27.0	50940/50941	50921	50627							
15178	90/25 mm	90	25	28.0	50940/50941	50921	50627							
15180	90/32 mm	90	32	30.0	50942	50922	50628							
15181	90/40 mm	90	40	34.0	50944	50924	50629							
15182	110/20 mm	110	20	27.0	50940/50941	50921	50631							
15184	110/25 mm	110	25	28.0	50940/50941	50921	50631							
15186	110/32 mm	110	32	30.0	50942	50922	50632							
15188	110/40 mm	110	40	34.0	50944	50924	50634							
15189	110/50 mm	110	50	34.0	50946	50926	50635							
15190	125/20 mm	125	20	27.0	50940/50941	50921	50636							
15192	125/25 mm	125	25	28.0	50940/50941	50921	50636							
15194	125/32 mm	125	32	30.0	50942	50922	50638							
15196	125/40 mm	125	40	34.0	50944	50924	50640							
15197	125/50 mm	125	50	34.0	50946	50926	50642							
15198	125/63 mm	125	63	38.0	50948	50928	50644							
15206	160/20 mm	160	20	27.5	50940/50941	50421	50648							
15208	160/25 mm	160	25	28.5	50940/50941	50421	50648							
15210	160/32 mm	160	32	30.0	50942	50422	50650							
15212	160/40 mm	160	40	34.0	50944	50424	50652							
15214	160/50 mm	160	50	34.0	50946	50426	50654							
15216	160/63 mm	160	63	38.0	50948	50428	50656							
15218	160/75 mm	160	75	42.0	50987**	-	50657							
15220	160/90 mm	160	90	45.0	50988**	-	50658							
15228	200-250/20 mm	200-250	20	27.5	50941	50421	50660/50672							
15229	200-250/25 mm	200-250	25	28.5	50941	50421	50660/50672							
15230	200-250/32 mm	200-250	32	30	50942	50422	50662/50674							
15231	200/40 mm	200	40	34	50944	50424	50664							
15232	200/50 mm	200	50	34	50946	50426	50666							
15233	200/63 mm	200	63	37.5	50948	50428	50668							
15234	200/75 mm	200	75	42.0	50987**	-	50667							
15235	200/90 mm	200	90	42.0	50988**	-	50669							
15236	200/110 mm	200	110	49.0	50989**	-	50670							
15237	200/125 mm	200	125	55.0	50990**	-	50671							
15251	250/40 mm	250	40	34	50944	50424	50676							
15252	250/50 mm	250	50	34	50946	50426	50678							
15253	250/63 mm	250	63	37.5	50948	50428	50680							
15254	250/75 mm	250	75	42.0	50987**	-	50682							
15255	250/90 mm	250	90	45.0	50988**	-	50684							
15256	250/110 mm	250	110	49.0	50989**	-	50686							
15257	250/125 mm	250	125	55.0	50990**	-	50688							
15260	315/63 mm	315	63	37.5	50948	-	50690							
15261	315/75 mm	315	75	42.0	50987**	-	50692							
15262	315/90 mm	315	90	45.0	50988**	-	50694							
15263	315/110 mm	315	110	49.0	50989**	-	50696							
15264	315/125 mm	315	125	55.0	50990**	-	50698							
15268	355/90 mm	355	90	45.0	50988**	-	50716							
15269	355/110 mm	355	110	49.0	50989**	-	50718							
15270	355/125 mm	355	125	55.0	50990**	-	50720							
315265	315/160 mm	315	160	80.0	50991**	-	50699							
315271	355/160 mm	355	160	80.0	50991**	-	50722							
15265	315/160 mm	315	160	80.0	50991**	-	50699							
15271	355/160 mm	355	160	-	50991**	-	50722							
15275	400-500/75 mm	400-500	75	-	50987**	-	50728							
15277	400-450/110 mm	400-500	110	-	50989**	-	50736							
15278	400/125 mm	400	125	-	50990**	-	50742							
15288	400-500/90 m	400-500	90	-	50988**	-	50732							
15290	450-500/125 m	400-500	125	-	50990**	-	50744							
15300	400-630/63 mm	400	63	-	50948	-	50726							
15303	500-560/110 mm	500-560	110	-	50989**	-	50738							
15315	560-630/75 mm	560-630	75	-	50987**	-	50730							
15316	560-630/90 mm	560-630	90	-	50988**	-	50734							
15318	560-630/125 mm	560-630	125	-	50990**	-	50746							
15331	630/110 mm	630	110	-	50989**	-	50740							

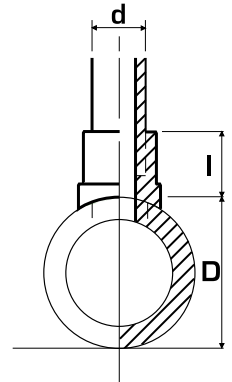

1) only for aquatherm blue pipe OT faser composite pipes, Art. no. 2170708-2170138
 ** only in conjunction with the aquatherm hole saw system

PART C: WELD-IN SADDLES

Art. no.	Dimension	D	d	l	Sensor-wells	Drill	Special peeling drill ¹	Tool
		mm	mm	mm	Art. no.	Art. no.	Art. no.	Art. no.
28214	40/25 x 1/2" f	40	1/2"	39,0	14	50940	50921	50614
28216	50/25 x 1/2" f	50	1/2"	39,0	14	50940	50921	50616
28218	63/25 x 1/2" f	63	1/2"	39,0	14	50940/50941	50921	50619
28220	75/25 x 1/2" f	75	1/2"	39,0	14	50940/50941	50921	50623
28222	90/25 x 1/2" f	90	1/2"	39,0	14	50940/50941	50921	50627
28224	110/25 x 1/2" f	110	1/2"	39,0	14	50940/50941	50921	50631
28226	125/25 x 1/2" f	125	1/2"	39,0	14	50940/50941	50921	50636
28230	160/25 x 1/2" f	160	1/2"	39,0	14	50940/50941	50921	50648
28232	200-250/25 mm x 1/2" f	200-250	1/2"	39,0	14	50941	50921	50660/50672
28234	40/25 x 3/4" f	40	3/4"	39,0	16	50940	50920	50614
28236	50/25 x 3/4" f	50	3/4"	39,0	16	50940	50921	50616
28238	63/25 x 3/4" f	63	3/4"	39,0	16	50940/50941	50921	50619
28240	75/25 x 3/4" f	75	3/4"	39,0	16	50940/50941	50921	50623
28242	90/25 x 3/4" f	90	3/4"	39,0	16	50940/50941	50921	50627
28244	110/25 x 3/4" f	110	3/4"	39,0	16	50940/50941	50921	50631
28246	125/25 x 3/4" f	125	3/4"	39,0	16	50940/50941	50921	50636
28250	160/25 x 3/4" f	160	3/4"	39,0	16	50940/50941	50921	50648
28254	200-250/25 mm x 3/4" f	200-250	3/4"	39,0	16	50941	50921	50660/50672
28260	75/32 x 1" f	75	1"	43,0	20	50942	50922	50624
28262	90/32 x 1" f	90	1"	43,0	20	50942	50922	50628
28264	110/32 x 1" f	110	1"	43,0	20	50942	50922	50632
28266	125/32 x 1" f	125	1"	43,0	20	50942	50922	50638
28270	160/32 x 1" f	160	1"	43,0	20	50942	50922	50650
28274	200-250/32 mm x 1" f	200-250	1"	43,0	20	50942	50922	50662/50674

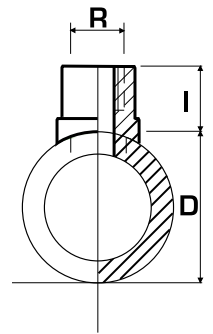

Art. no.	Dimension	D	d	l	Drill	Special peeling drill ¹	Tool
		mm	mm	mm	Art. no.	Art. no.	Art. no.
28314	40/25 x 1/2" m	40	1/2"	55,0	50940	50921	50614
28316	50/25 x 1/2" m	50	1/2"	55,0	50940	50921	50616
28318	63/25 x 1/2" m	63	1/2"	55,0	50940/50941	50921	50619
28320	75/25 x 1/2" m	75	1/2"	55,0	50940/50941	50921	50623
28322	90/25 x 1/2" m	90	1/2"	55,0	50940/50941	50921	50627
28324	110/25 x 1/2" m	110	1/2"	55,0	50940/50941	50921	50631
28326	125/25 x 1/2" m	125	1/2"	55,0	50940/50941	50921	50636
28330	160/25 x 1/2" m	160	1/2"	55,0	50940/50941	50921	50648
28334	40/25 x 3/4" m	40	3/4"	56,0	50940	50921	50614
28336	50/25 x 3/4" m	50	3/4"	56,0	50940	50921	50616
28338	63/25 x 3/4" m	63	3/4"	56,0	50940/50941	50921	50619
28340	75/25 x 3/4" m	75	3/4"	56,0	50940/50941	50921	50623
28342	90/25 x 3/4" m	90	3/4"	56,0	50940/50941	50921	50627
28344	110/25 x 3/4" m	110	3/4"	56,0	50940/50941	50921	50631
28346	125/25 x 3/4" m	125	3/4"	56,0	50940/50941	50921	50636
28350	160/25 x 3/4" m	160	3/4"	56,0	50940/50941	50921	50648

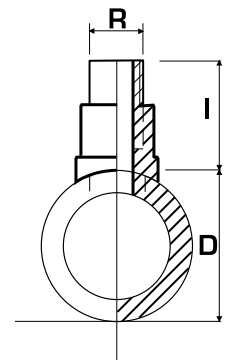

¹ only for aquatherm blue pipe OT faser composite pipes, Art. no. 2170708-2170138

PART C: WELD-ON SADDLE

Drilling of aquatherm PP-pipes with the hot tapping tool Art. no. 50890 under pressure.

The aquatherm weld-on saddle set (consisting of ball valve, pipe and saddle in the dimensions 40 mm and 63 mm) is used for the additional installation of branch connections.

The PP-R pipes aquatherm green pipe, blue pipe and lilac pipe with the pipe structure S, MF and MF UV in the dimensions 75–630 mm can be drilled under pressure.

SAFETY INSTRUCCION::

The medium pressure (e.g. water) in the main pipe of 6 bar and the medium temperature of max. 60 °C must not be exceeded.

1. Preparation and fusion

After removal of the oxide layer on the main pipe and the cleaning of the welding surfaces, the welding device is placed with the weld-on saddle tool on the surfaces to be welded. Under gentle pressure and a warm-up time of 90 sec. an even bead must be there on the welding surfaces. After a warm-up time, the component is placed quickly on the main pipe. The component is fixed and aligned on the main pipe for max. 15 seconds. The connection is fully able to work under pressure after a cooling time of 15 minutes.

2. Assembly of the hot tapping tool

The hot tapping tool is screwed onto the component with the retracted drill rod, which is secured by the clamping claw. The screw connection on the ball valve is tightened by hand. After the ball valve has been opened, the welded component in conjunction with the hot tapping tool is tested for leaks with water or air.

3. Drilling process

When the clamping claw is loosened, the drill rod is pushed until the drilling tool contacts the pipe. Depending on the branch size, the appropriate feed rate must be set. The drilling is carried out by actuating the ratchet handle and simultaneously by giving a manually sensitive feed on the feed handles. After completion of the drilling and the release of the clamping claw, the drill rod is lead back to the stop by hand. Caution: The drill rod can rebound by the pressure in the pipe. The ball valve is then closed and the hot tapping device is relieved of pressure.

4. Disassembly

Detach the hot tapping device by holding the screw on the ball valve and remove it from the component. Pull the drill rod out of the hot tapping device and screw the drilling tool from the drill rod using a suitable wrench or armature tongs.



Hot tapping device Art.no. 50890



1. Welding-on of weld-on saddle set onto the main pipe



2. Assembly of the hot tapping tool onto the component



3. Start of the drilling process



4. Removal of the drilling residues out of the drilling tool

PART D: PULLING JIG (HITCH)

Notice

The following description of the electric pulling jig applies to the type of the year 2013.

Operation and fusion

With the help of the electric pulling jig, all aquatherm PP-R-pipes and fittings in dimensions from 63 to 125 mm are in a very simple manner without any effort welded together.

Also the pulling jig simplifies the welding of pipes and fittings under ceilings, in narrow shafts and other hard-to-reach places.

1. Preparation for the fusion

Mark the welding depth with the included green marking template on the pipe end (Fig. 1). In addition, the clamping depth is measured 2 cm from the welding depth marking and marked again (Fig. 2 + 3).



PART D: PULLING JIG (HITCH)

1. Preparation for the fusion

The pulling jig is now placed on the fitting or pipe to be welded with the clamping jaws (Fig. 4).

The two arrows of the jaws and the machine must be flush with each other. The jaws are to be fixed with the help of the clamping device (Fig. 5).

Align the pipe so that the rear marking is flush with the inner edge of the clamping jaw. The front marking identifies the welding depth (Fig. 6).

Lock pipe and fitting by using the front adjusting screws (Fig. 7).

Never clamp so tight that deformations appear. Additionally, with the fitting support, all fittings are supported. The support is mounted on the clamping jaw for fittings (Fig. 8).

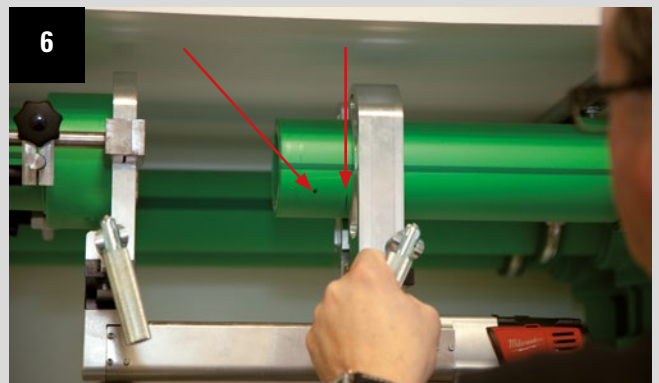
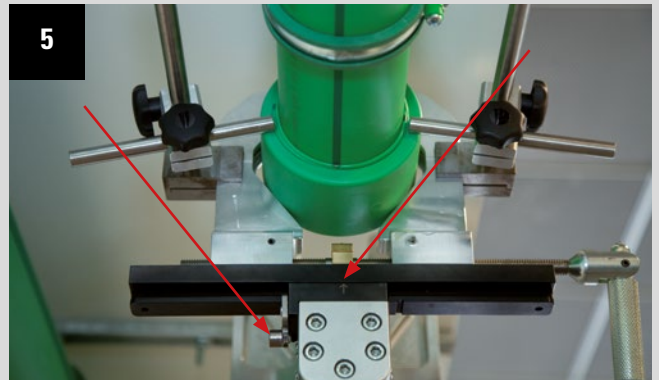

PART D: PULLING JIG (HITCH)

2. Fusion

Hold the welding device between pipe and fitting and ride machine carriage in batches together (pay attention to the welding depth).

Basically the jaws must be released after the insertion of pipe and fitting in the welding tool by a short return of the machine (3–7 mm)! The jaws must always be parallel to each other (Fig. 9 +10).

After finishing of the warm-up drive the machine carriage apart and remove the welding device (Fig. 11).

Ride the jaws together again and release the clamping jaws again by a short return of the machine (3–7 mm) (Fig. 12).

CAUTION:

Jaws may be released only after the expiry of the cooling time!

Pipe and fitting are now joined by fusion to a material unit (Fig. 13).

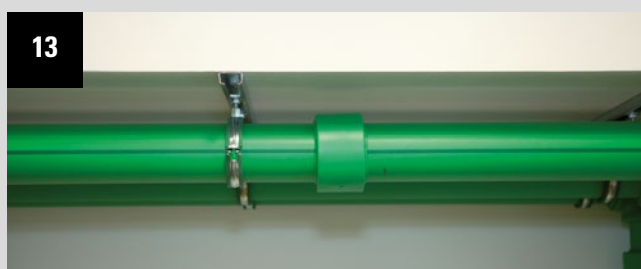

The fusion is subject to the following data

Pipe external- Ø	Welding depth	Heating time		Welding time	Cooling time
		sec. DVS	sec. AQT*		
mm	mm	sec.	sec.	sec.	min.
63	27,5	24	36	8	6
75	30,0	30	45	8	8
90	33,0	40	60	8	8
110	37,0	50	75	10	8
125	40,0	60	90	10	8

ATTENTION: sec. AQT* heating times recommended by aquatherm at ambient temperatures below + 5 °C

The General Guidelines for Heated Socket Welding acc. to DVS 2207, Part 11 are applied hereupon.

PART E: AQUATHERM WELDING MACHINE

for stationary processing 50–125 mm

precise pre-assembly and facilitation by hand creek

clamping jaws 50–125 mm, tools 50–125 mm

Scope of supply:

wooden transport box, slide with sub construction, clamping jaws 50–125 mm, welding tools 50–125 mm, stay with rolls

For welding of aquatherm green pipe/aquatherm blue pipe/aquatherm lilac pipe a welding temperature of 260 °C at the welding tools is necessary (see page 49).

Instructions for use can be taken from the attached operation manual.



The fusion is subject to the following data

Pipe external- Ø	Welding depth	Heating time		Welding time	Cooling time
		sec. DVS	sec. AQT*		
mm	mm	sec.	sec.	sec.	min.
50	23,5	18	27	6	4
63	27,5	24	36	8	6
75	30,0	30	45	8	8
90	33,0	40	60	8	8
110	37,0	50	75	10	8
125	40,0	60	90	10	8

ATTENTION: sec. AQT* heating times recommended by aquatherm at ambient temperatures below + 5 °C

The General Guidelines for Heated Socket Welding acc. to DVS 2207, Part 11 are applied hereupon.

Dimension 160–630 mm:

The dimension 160–630 mm are joined by butt-welding.

Detailed information on page 66–71.

PART E: WELDING MACHINE PRISMA-LIGHT

Welding machine prisma-light with heating plate without tools

Clamping fixture for fixing the prisma-light e. g. at the work bench

1. Check machine: temperature lamp blinks after reaching the welding temperature (260 °C), adjust clamping jaws 63–125 mm coarsely. Mark welding depth with the template at the pipe.
2. Fix the fitting against the clamping jaws.
3. Place the pipe loose in the opposite clamping jaws.
4. Position the welding device centrally to the pipe-fitting axis and remove it.
5. Lock the front calibration knob and drive up the slide as far as it will go.
6. In this position push the pipe against the fitting and fix it with the clamping jaws.
7. Regulate the welding time according to the table on page 59, place the welding device and push the fitting and pipe slowly as far as it will go up to the marking.
8. The heating time starts when pipe and fitting are completely pushed on the tool. When heating time is complete slide return the slide, remove the heating device quickly and join the pipe and fitting.
9. Consider cooling times from the table on page 59.

More detailed information can be taken from the enclosed operating manuals.

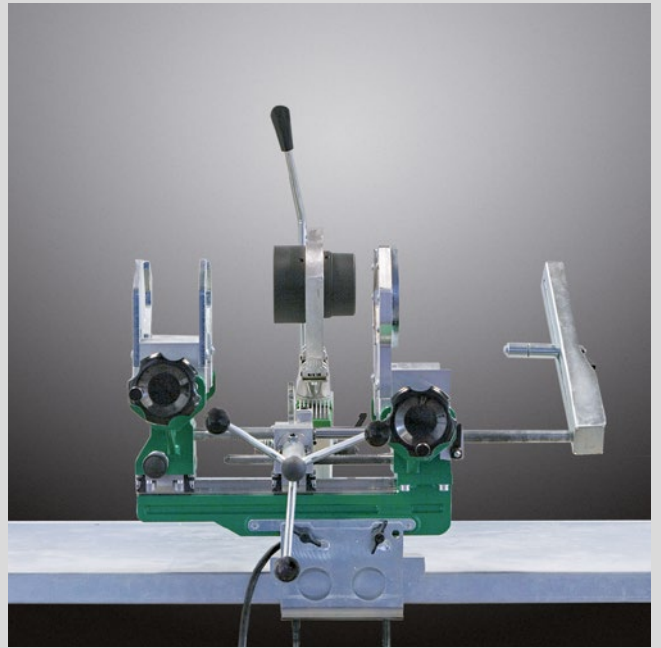

PART F: ELECTROFUSION DEVICE

Fusion

The aquatherm electrofusion device was specially developed for electrofusion sockets from Ø 20–250 mm.

The fusion of 160–250 mm aquatherm blue pipe MF OT with the electrofusion socket is not possible.

Technical information:

supply voltage: 230 V (nominal voltage)
 nominal capacity: 2.800 VA, 80 % ED
 rated frequency: 50–60 Hz
 protection class: IP 54

1. General and inspection

Cleanliness is – besides correct workmanship – the most important precondition for a correct fusion. For keeping the sockets clean do not unwrap them before processing.

The pipe surface must also be clean and undamaged. Deformed pipe ends must be cut off.

All parts of the system to be fused as well the temperature sensors shall have the same temperature (e.g. sun radiation or unadapted storing may cause differences in temperature!) within the acceptable range of temperature (e.g. +5 °C to 40 °C according to DVS 2207).

2. Preparation

Follow carefully the order of working steps!

Preparation is one of the most important steps of the electrofusion process!

- a. Cut the ends of the pipes rectangularly and deburr them thoroughly
- b. Clean and dry the ends of the pipes at the necessary length
- c. Mark the depth of aquatherm electro-fusion-socket on the end of the pipe



aquatherm electrofusion device Ø 20–250 mm



aquatherm electrofusion socket

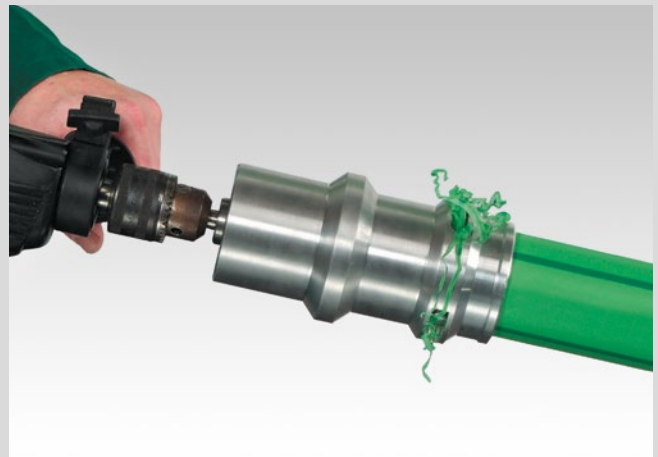

aquatherm peeling tool (Art. no. 50558–50572, up to 90 mm)
 (from 110–250 mm: Art. no. 50574–50592 (without picture))

Welding depth up to 250 mm													
Ø	20	25	32	40	50	63	75	90	110	125	160	200	250
ET	35,0	39,0	40,0	46,0	51,0	59,0	65,0	72,5	80,0	86,0	93,0	105,0	125,0

TEIL F: ELECTROFUSION DEVICE

Fusion

- d. Peel the surface of both pipes up to the marks thoroughly with a peeling tool (use the aquatherm peeling tool with the respective pipe diameter)

IMPORTANT!

Before the fusion peel off the oxygen barrier layer of the aquatherm blue pipe OT and the UV-layer of the faser composite pipe UV completely to the stop by using the universal peeling tools considering the pipe diameter.

By turning the adjusting screw clockwise to the stop, the peeling tools can be adjusted into small depths (sockets), by turning them counter clockwise up to the stop they can be adjusted into big peeling depth (electrofusion sockets).

e. Clean again thoroughly

Without complete peeling of the fusion surface a homogeneous and tight welding connection is not assured. Damages of the surface like axial grooves and scratches are not accepted in the fusion zone. Never touch peeled surfaces and protect them against dirt and grease. Start the fusion process within 30 mins after peeling.

3. Assembling the electrofusion sockets

Avoid soiling and fix all parts securely!

1. Open the protective wrapping of the aquatherm electrofusion sockets (cut with knife along the edge of the bore), leaving the rest of the foil intact. Clean the inside of the fitting carefully with aquatherm cleaning wipes. Assemble the fitting within 30 mins after opening of the protective foil.
2. Push the aquatherm electrofusion sockets on the clean and dry end of the pipe (up to the marked depth). Use pressing clamps if necessary.



Cut the pipes to be welded, peel, clean and dry thoroughly with a lint-free cloth or paper



Clean the electrofusion socket's inner surface with a lint-free cloth or paper. Remove moisture that may occur **immediately before the welding process** again.



Push the electrofusion socket onto the pipe end



PART F: ELECTROFUSION DEVICE

Remove the protective foil completely and push the other prepared pipe end into the aquatherm electro-fusion sockets tighten in the fixation.

Leave the pipes, free from bending stress or own weight, within the aquatherm electrofusion socket. The socket is movable at both pipe ends after assembling. The air gap has to be even around the circumference. Pipes and fittings must be welded stress-free.

4. Fusion process

1. Position the fitting with even air gap around the circumference.
2. Regulate fusion equipment for the right fusion parameter.
3. Compare the indications of the fusion equipment with the parameters of the label.
4. Start and watch the fusion process.

Do not move or stress pipe and fitting during the whole fusion process and cooling time.

5. Cooling time and pressure test

A fused pipe-joint shall not be moved (no release of the fixation) or stressed before complete cooling.

The minimum required cooling time is marked on each aquatherm electrofusion socket. Ambient temperatures of more than 25 °C or strong sun-radiation need longer cooling times.

Working pressure

The operation pressure can be taken from the imprint on the electric welding socket. The relation between working temperature, pressure load and service life is given in the tables "Permissible working pressure."

For further information concerning electrofusion socket and details about the aquatherm electrofusion device read the enclosed operating instructions.



Push the second pipe – also peeled and cleaned – into the socket

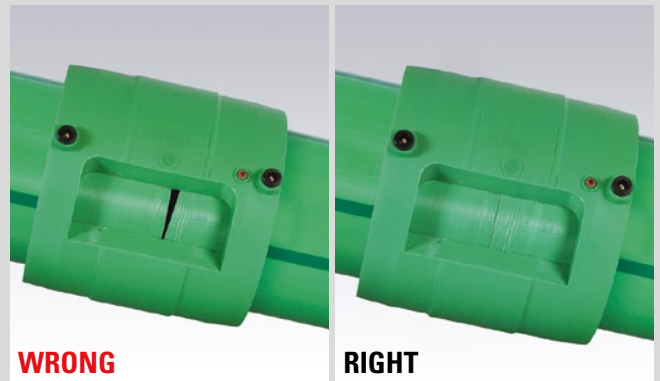

For a stable welding result it is important that both pipe ends inside the electrofusion socket are with parallel faces! Follow the minimum welding depth – absolutely!



Adjust the socket diameter on the welding device. Start and control welding process. Keep the cooling time. Finished!

Kind of stress	Compressive stress	Minimum waiting period
Tension, bend, torsion of unpressurized pipes		20 minutes
Test- or working pressure of pipes pressurized	up to 0.1 bar (1.5 psi) 0.1 up to 1 bar (1.5–14.5 psi) over 1 bar (14.5 psi)	20 minutes 60 minutes 120 minutes
Repeating of the welding process		60 minutes

POSSIBILITIES OF REPAIR

Pipe repairs with the aquatherm green pipe electrofusion socket

Cut squarely 3 to 4 lengths of a fitting out of the defect pipe, symmetrically to the defect. Fit the new pipe into this gap. Prepare the pipe ends of the existing pipe as in the case of a new welding.

Peel the new piece of pipe on both sides with the peeling tool on a length of more than the length of one fitting.

Unwrap two fittings and carefully move the fittings over both ends of the new pipe.

Then place the repair-pipe into the gap and move the fittings until they are aligned with the markings on the existing pipes.

Take care, that the fittings are exactly aligned and completely free of stress before welding.

Additional possibilities of repair

Damaged pipes may be repaired – as already mentioned – by means of

fusion (see Part B)
electrofusion socket (see Part F).

In addition to this the aquatherm PP-R-systems offers the possibility of the

pipe repair stick.

The necessary welding tool (Art. no. 50307/11) and repair stick (Art. no. 60600) are described on page 177.

The installation information is enclosed with the welding tool, but may also be ordered separately (Order-No. D 11450) from aquatherm.

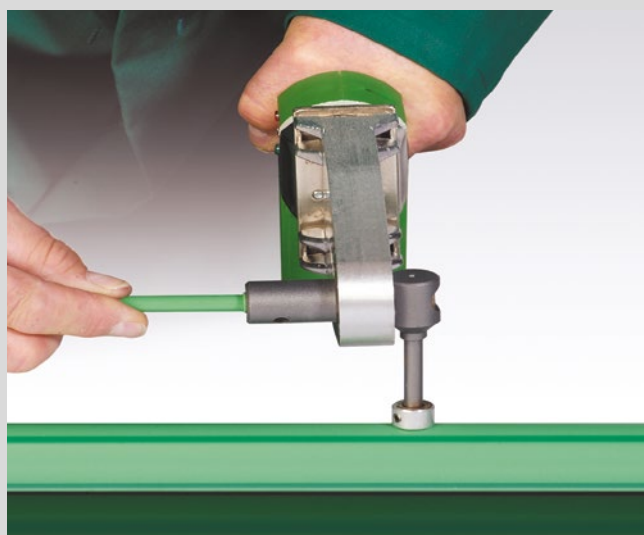

Heat-up

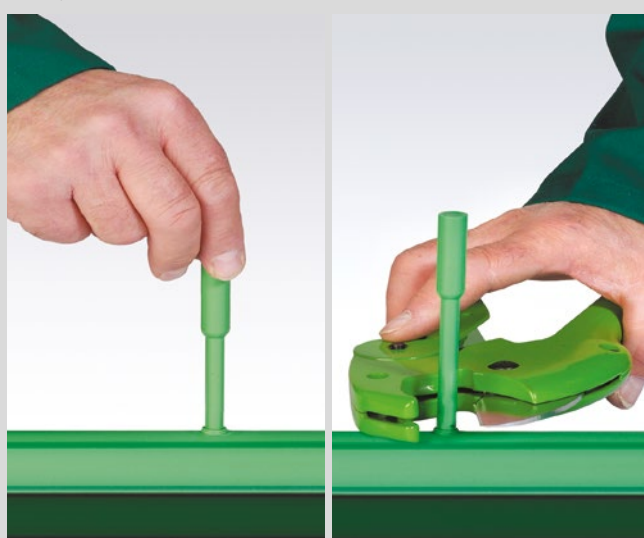

Repair stick

Cutting

PART H: BUTT-WELDING OF PIPE DIMENSION

160–630 mm

The following aquatherm pipes series are available:

aquatherm green pipe SDR 11 S for cold water

aquatherm green pipe SDR 7.4 / 9 / 11 MF faser-composite pipe

aquatherm blue pipe SDR 11 / 17.6 MF faser-composite pipe

aquatherm blue pipe SDR 11 MF OT faser-composite pipe

Pipes and fittings are fused, as explained below, by butt welding:

1. Protect your place of work from weather influences
2. Check, if welding machine works properly and heat it up
3. Cut pipes into required length
4. Plastic pipes are aligned and fixed by means of the clamping elements
5. Use the milling machine for planing the pipe end to be plane-parallel
6. Remove the debris and clean the pipe ends with methylated spirit
7. Check if pipes match (tolerance: max. 0.1 x wall thickness)
8. Check width of gap between the two pipes to be welded (tolerance: max. 0.5 mm)
9. Check the temperature of the heating element (210 °C +/- 10 °C)
10. Clean the heating element

IMPORTANT:

Before welding, the side to be welded of the aquatherm blue pipe ot must be chamfered with the aquatherm chamfering tool (page 179).

To ensure an optimal weld joint, the heating plates' surfaces have to be cleaned before each welding process and be free of visible and invisible residues.



Before welding, pipes are cut into the required lengths

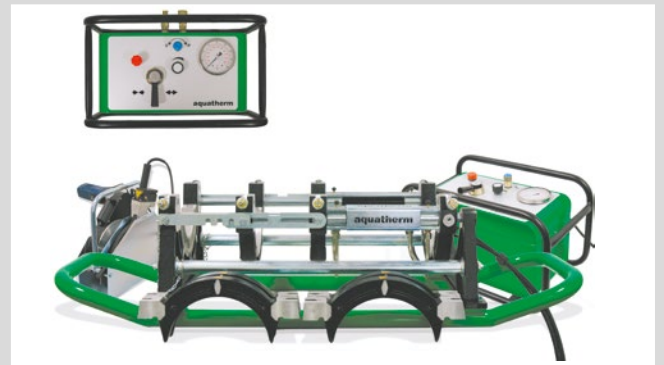

Check performance of the welding machine and heat it up

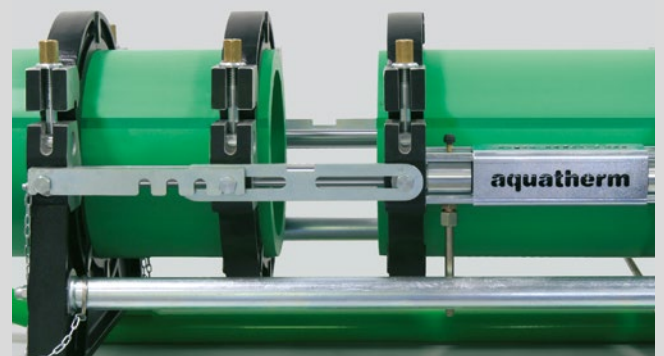

The parts to be welded are fixed and aligned respectively, the milling machine is used

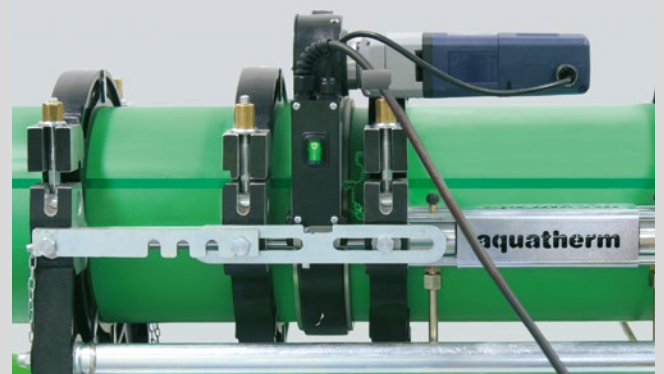

Chamfering of the front side in case of the OT and UV pipe

PART H: BUTT-WELDING OF PIPE DIMENSION

160–630 MM

11. After the heating element has been positioned, the pipes are pushed onto the heating plate with a defined adjusting pressure.
12. After reaching the specified bead height (see tablet) the pressure is reduced. This process marks the beginning of the heating time. This time is for heating up the pipe ends up to the right welding temperature.

Specified bead height in mm:

	SDR 7,4	SDR 11	SDR 9	SDR 17,6
160 mm	1,5	1,0	1,0	1,0
200 mm	2,0	1,0	1,5	1,0
250 mm	2,0	1,5	2,0	1,0
315 mm	-	2,0	2,0	1,0
355 mm	-	2,0	2,5	1,5
400 mm	-	2,0	-	1,5
450 mm	-	2,5	-	1,5
500 mm	-	-	-	2,0
560 mm	-	-	-	2,0
630 mm	-	-	-	2,0

13. When heating time has expired, divide the machine slide, remove heating element quickly and join the pipes (by putting both parts of the slide together).
14. The pipes are fused with the required welding pressure and cooled down under pressure.
15. The welded connection can be unclamped – the welding process is finished.

Additionally please follow the instructions given in the operating manual of the welding machine and observe guideline DVS 2207, part 11.

Important Note

1. The welding machines have to be suitable for the welding of pipes with a diameter/wall thickness ratio of up to SDR 7.4

aquatherm recommends the following manufacturers of welding machines for butt welding:

Company Ritmo
Company Widos

2. For hydraulically operated welding machines, the real manometer pressure has to be calculated in consideration of the hydraulic piston area.

This value can be taken from the respective operating manuals.

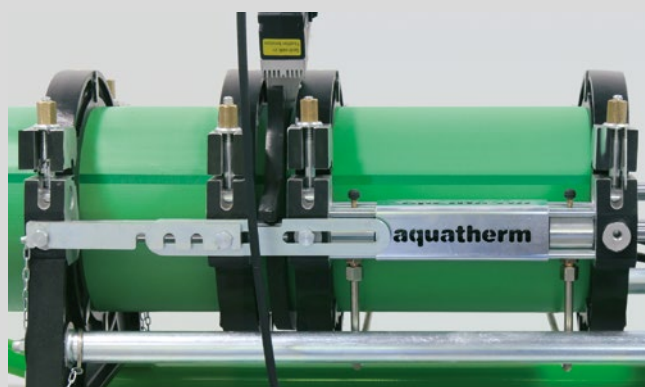

Positioning of heating element

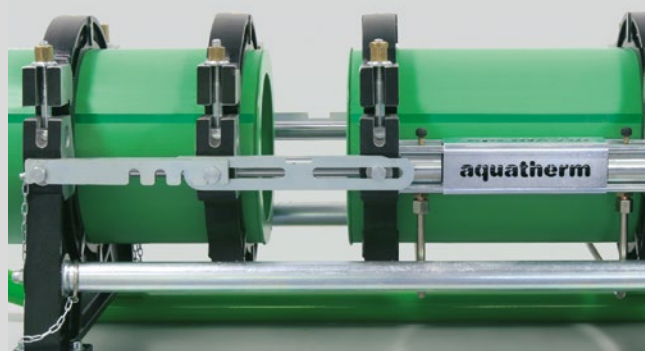

Divide the machine slide, remove heating element

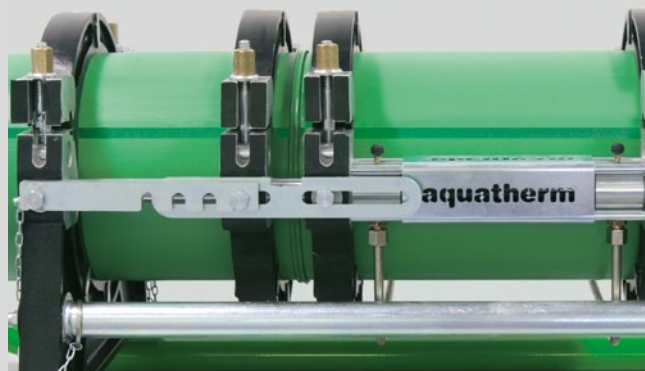

Join the pipes, cool down under pressure



Unclamp and work on...

Visual inspection of fusion seam – Misalignment and gap width for butt welding

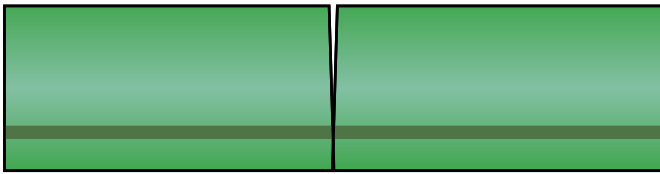

Gap width up to 355 mm outer diameter = 0.5 mm
 Gap width from 400 mm to 630 mm outer diameter = 1 mm

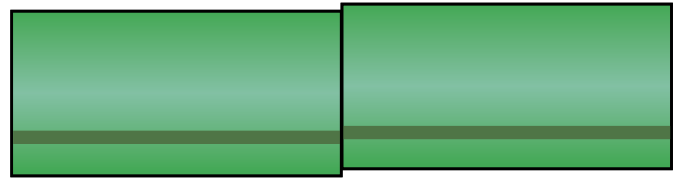

The misalignment cannot be more than 10% of the wall thickness or max. 2 mm

Welding defects during butt-welding

Normally a bead around the entire circumference is formed at the edge of the socket during the welding process. This bead indicates the proper welding. It is important to assure that the following welding defects are avoided:

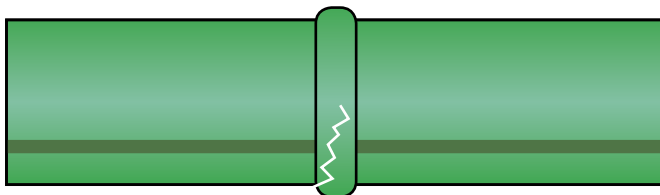

Cracks

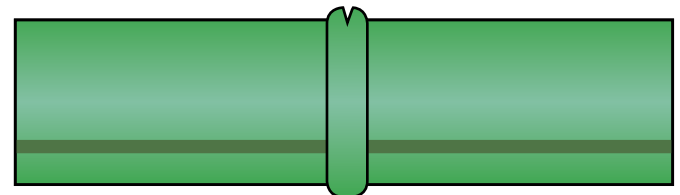

Grooves in the bead

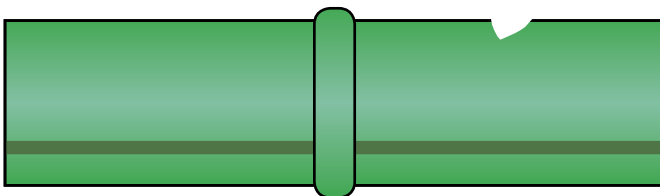

Grooves and scratches

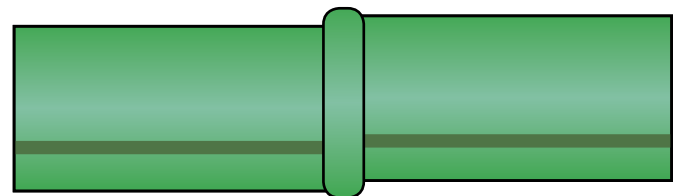

Misalignment of the joining area

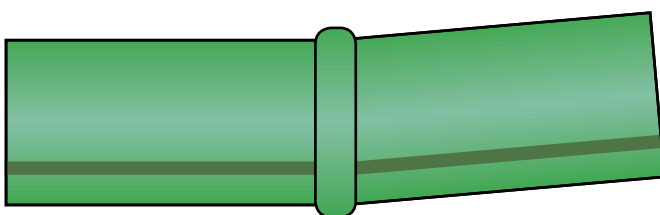

Tilting of the joining area

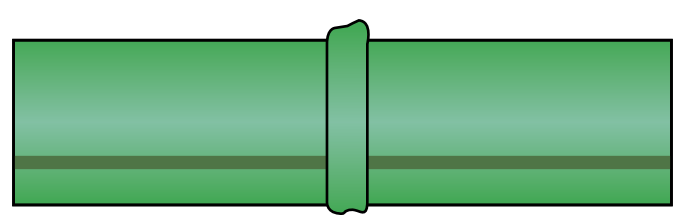

Uneven welding bead

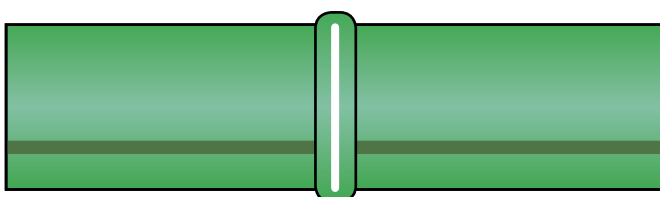

Lack of fusion at the joining area

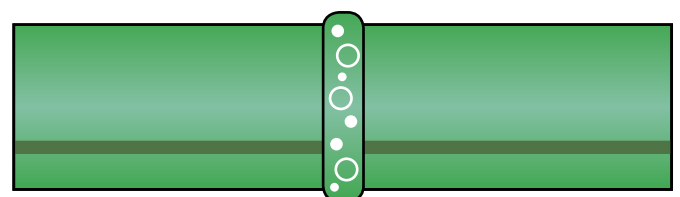

Pores, voids and inclusion of impurities

Correct butt welded seam

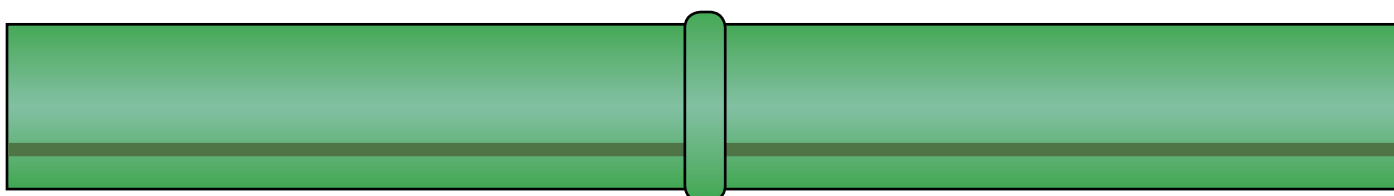

The visual inspection may be only a first indication of the welding seam quality. But it is not a replacement for the leak test, which has to be carried out after the completion of the installation.

Requirements for welding



The immediate welding area is to be protected against bad climatic conditions (e.g. wind, moisture and low temperatures).



If the pipes are heated unevenly as a result of sun exposure, temperature compensation by timely covering of the welding area is to be created. Cooling down by draft during the welding process should be avoided.



For perfect welding joints, both the welding areas and tools must be clean and free of grease.

AQUATHERM WELDING PARAMETERS
WELDING TEMPERATURE: 210 °C +/- 10 °C

The calculated drag pressure is added to the adjustment and welding pressure (see description)

ATTENTION: When using other welding machines, the pressures P1, P2 and P3 must be adjusted.

Excerpt from the DVS 2207 part 11

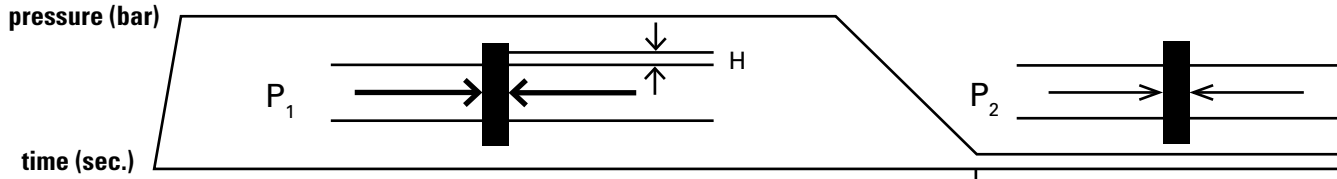

Dimension (mm)	Pipe series SDR	P1 Adjustment pressure (bar)					Height of bead (mm)	P2 Heating pressure (bar)		
		Rothenberger Art. no. 50163, 50167 + 50178	Ritmo Art. no. 50165	Ritmo Art. no. 50166	Ritmo Art. no. 50177	Ritmo Art. no. 50169		Rothenberger Art. no. 50163, 50167 + 50178	Ritmo Art. no. 50165	Ritmo Art. no. 50166
160x9,1	17,6	7	7	6	3		1	1	1	
160x14,6	11	11	11	10	5		1	1	1	
160x17,9	9	13	13	12	6		1	1	1	
160x21,9	7,4	15	16	14	7		1,5	2	2	
200x11,4	17,6	11	11	10	5		1	1	1	
200x18,2	11	17	18	16	7		1	2	2	
200x22,4	9	20	21	19	9		1,5	2	2	
200x27,4	7,4	24	25	22	11		2	2	3	
250x14,2	17,6	17	18	16	7		1	2	2	
250x22,7	11	26	28	24	11		1,5	3	3	
250x27,9	9	31	33	29	14		2	3	3	
250x34,2	7,4	37	39	35	16		2	4	4	
315x17,9	17,6	27		25	12	8	1	3	3	
315x28,6	11	41		38	18	13	2	4	4	
315x35,2	9	49		46	22	15	2	5	5	
315x42,6	7,4	59		56	26	18	2,5	6	6	
355x20,1	17,6	34			15	10	1,5	3		
355x32,2	11	52			23	16	2	5		
355x39,5	9	63			28	19	2,5	6		
355x49,0	7,4	77			33	23	2,5	7		
400x22,7	17,6					13	1,5			
400x36,3	11					20	2			
400x44,5	9					24	2,5			
450x25,5	17,6					17	1,5			
450x40,9	11					26	2,5			
500x28,4	17,6					21	2			
500x45,5	11					32	2,5			
560x31,7	17,6					26	2			
630x35,7	17,6					33	2			

Note: A reduction of the cooling time up to 50 %, i.e. release of the jointing pressure and removal of the welded part from the welding machine is allowed under the following conditions:

- The joint connection is manufactured under factory conditions and
- The removal from the welding machine and the temporary storage cause only a slight load to the joint connection and
- The joining parts have a wall thickness ≥ 15 mm

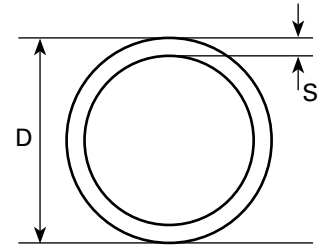

Further processing with full mechanical load on the jointing connection may be effected only after complete cooling down according to the table.

		t_2			t_3					t_4	
					P ₃ Adjustment pressure (bar)						
Ritmo Art. no. 50177	Ritmo Art. no. 50169	Heating time DVS 2207 (sec.)	Max. changeover time (sec.)	Max. pressurization time (sec.)	Rothenberger Art. no. 50163, 50167 + 50178	Ritmo Art. no. 50165	Ritmo Art. no. 50166	Ritmo Art. no. 50177	Ritmo Art. no. 50169	Cooling time (min.)	
		t ₁	t ₂	t ₃						t ₄	
0		204	6	9	7	7	6	3			15
0		277	8	13	11	11	10	5			24
1		315	9	16	13	13	12	6			28
1		359	10	19	15	16	14	7			34
0		237	7	11	11	11	10	5			19
1		320	9	16	17	18	16	7			29
1		364	10	19	20	21	19	9			35
1		411	11	23	24	25	22	11			42
1		272	8	13	17	18	16	7			23
1		367	10	20	26	28	24	11			35
1		415	12	24	31	33	29	14			43
2		463	13	29	37	39	35	16			51
1	1	317	9	16	27		25	12	8		28
2	1	412	12	24	41		38	18	13		44
2	2	471	14	30	49		46	22	15		53
3	2	520	15	37	59		56	26	18		62
1	1	341	9	18	34			15	10		32
2	2	448	13	28	52			23	16		48
3	2	501	15	34	63			28	19		58
3	2	551	17	42	77			33	23		68
	1	367	10	20					13		35
	2	480	14	31					20		54
	2	528	16	39					24		63
	2	395	11	22					17		39
	3	508	15	35					26		59
	2	419	12	24					21		43
	3	534	16	39					32		65
	3	444	12	27					26		48
	3	475	14	31					33		53

FLANGE CONNECTIONS

THE FOLLOWING MUST BE OBSERVED IN THE USE OF FLANGE CONNECTIONS:

Flange adapter respectively the sealing surfaces must always be aligned parallel to each other. A subsequent tightening of the flange connection after the welding process must be avoided. It is important to ensure that the flange faces are clean and undamaged.

The screw length should be selected so that the screw thread is as flush as possible, maximum two threads from the nut. To distribute the force of the screw head and the nut over a larger area, washers are used. Screws, nuts and washers must be clean and undamaged.

In order to achieve proper force distribution (surface pressure) acting on the seal, note the following:

- Screw joints must be tightened diagonally and evenly
- Torque information on the individual flanges must be observed (see table)

For flange connections, exposed to a mutual load, take care that they are checked as part of the maintenance and retightened, if necessary.

TORQUE FLANGE according to manufacturer's instructions

Art. no.	Dimension	DN specification	Nm
15712	32 mm	25	15
15714	40 mm	32	20
15716	50 mm	40	30
15718	63 mm	50	35
15720	75 mm	65	40
15722	90 mm	80	40
15724	110 mm	ohne	50
15726	125 mm	100	50
15730	160 mm	125	60
15734	200 mm	150	75
15738	250 mm	200	95
15742	315 mm	250	100
15744	355 mm	300	100
15746	400 mm	350	244-366
15748	450 mm	400	271-407
15750	500 mm	450	271-407
15752	560 mm	500	353-529
15754	630 mm	500	393-590

TIGHTENING SEQUENCE

Number of screws	Criss-Cross Pattern Tightening Sequence
4	1 - 3 - 2 - 4
8	1 - 5 - 3 - 7 - 2 - 6 - 4 - 8
12	1 - 7 - 4 - 10 - 2 - 8 - 5 - 11 - 3 - 9 - 6 - 12
16	1 - 9 - 5 - 13 - 3 - 11 - 7 - 15 - 2 - 10 - 6 - 14 - 4 - 12 - 8 - 16
20	1 - 11 - 6 - 16 - 3 - 13 - 8 - 18 - 5 - 15 - 10 - 20 - 4 - 14 - 9 - 19 - 7 - 17 - 2 - 12

Following the table, tighten the given screw number to the desired torque value for the given round of tightening.

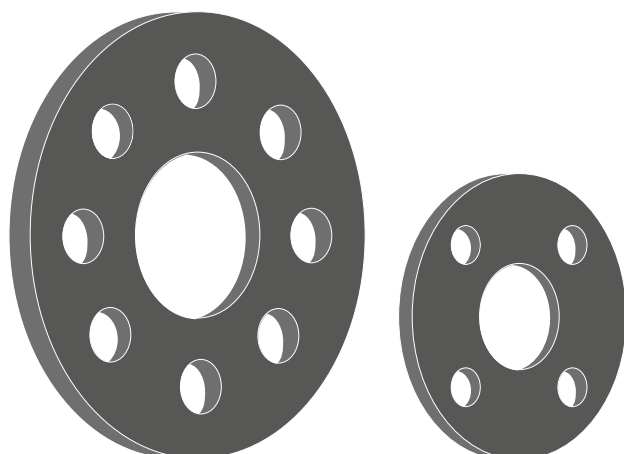
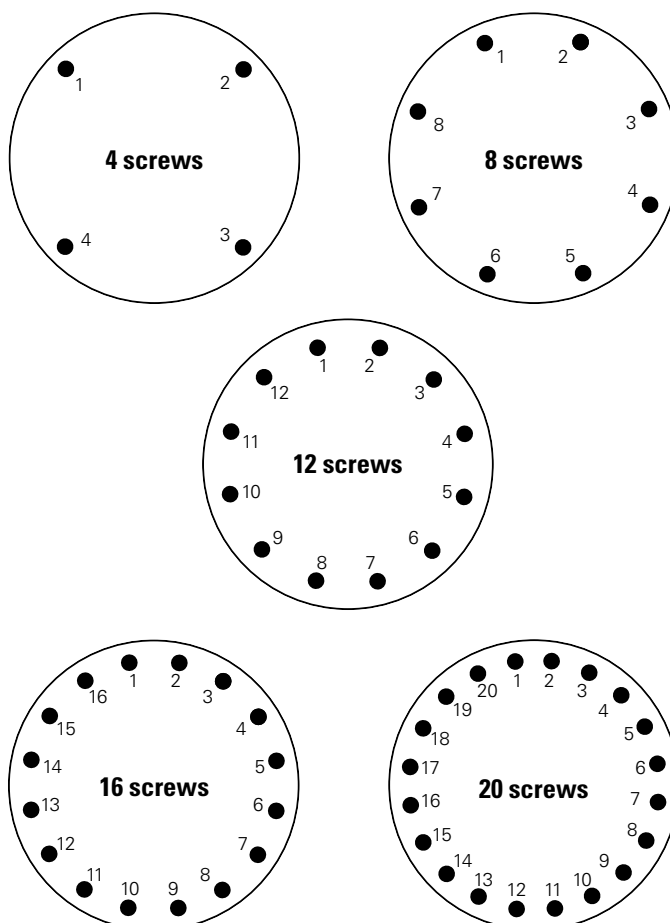

FASTENING TECHNIQUE / FIXED POINTS / SLIDING POINTS

Fastening technique

Pipe clamps for aquatherm PP-R-pipes must be dimensioned for the external diameter of the plastic pipe.

Take care, that the fastening material does not mechanically damage the surface of the pipe (aquatherm pipe clamps Art. no.: 60516–60660).

All pipes should be fastened with only aquatherm's green rubber compound fasteners, with expansion spacers, or other as deemed equal or approved by aquatherm and /or the project's Hydraulic Consultant.

Basically it must be distinguished on pipe assembly, whether the fastening material is used as

a fixed point or
a sliding point.

Fixed points

On locating fixed points the pipelines are divided into individual sections. This avoids uncontrolled movements of the pipe.

In principle fixed points have to be measured and installed in a way, that the forces of expansion of aquatherm PP-R-pipes as well as probable additional loads are accommodated.

On using threaded rods or threaded screws the drop from the ceiling should be as short as possible. Swinging clamps should not be used as fixed points.

Basically vertical distributions can be installed. Risers do not require expansion loops, provided that fixed points are located immediately before or after a branch.

To compensate the forces arising from the linear expansion of the pipe there must be sufficient and stable clamps and mountings.

aquatherm pipe clamps meet all mentioned requirements and – when considering the following installation instructions – are perfect for fixed point installations.

Sliding points

Sliding clamps have to allow axial pipe movements without damaging the pipe.

On locating a sliding clamp it has to be ensured that movements of the pipelines are not hindered by fittings or armatures installed next to the clamps.

aquatherm pipe clamps have an extra even and sliding surface of the sound insulation insert.

INSTALLATION ADVICE / LINEAR EXPANSION / CONCEALED INSTALLATION

Installation advices

aquatherm pipe clamps are perfectly suited for fixed point and sliding point installations.

The application of distance rings depends on the type of pipe.

Fastening	MF Pipes (faser composite pipe) & S Pipes (single layer)
Sliding Point	1 distance ring
Fixed point	no distance ring

Linear expansion

The linear expansion of pipes depends on the difference of operating temperature to installation temperature:

$$\Delta T = T_{\text{operating temperature}} - T_{\text{installation temperature}}$$

Therefore cold water pipes have practically no linear expansion.

Because of the heat dependent expansion of the material, the linear expansion must especially be considered in case of hot and heating installations. This requires a distinction of the types of installation, e.g.

- **Concealed installation**
- **Installation in ducts**
- **Open installation.**

Concealed installation

Concealed installations generally do not require a consideration of the expansion of aquatherm PP-R-pipes.

The insulation acc. to DIN 1988 or the EnEV (Energieeinsparverordnung) provides enough expansion space for the pipe. In the case where the expansion is greater than the room to move in the insulation, the material absorbs any stress arising from a residual expansion.

The same applies to pipes, which do not have to be insulated acc. to current regulations.

A temperature induced linear expansion is prevented by the embedding in the floor, concrete or plaster. The compressive strain and tensile stress arising from this are not critical as they are absorbed by the material itself.

INSTALLATION IN DUCTS

Installation in ducts (vertical)

Due to the different linear expansion of the aquatherm PP-R-pipes with or without stabilization, the installation of pipe branches in risers has to be made according to the selected type of pipe.

aquatherm green pipe MF **aquatherm blue pipe MF**

The linear expansion of aquatherm faser composite pipes in vertical risers can be ignored.

The positioning of a fixed point directly before each branch-off point is sufficient. All clamps in the riser must be installed as fixed points (see 1).

In general it is possible to install risers rigidly, that means without expansion joints. This directs the expansion on the distance between the fixed points, where it is ineffective.

For a maximum distance between two fixed points please refer pages 79/80.

aquatherm green pipe **aquatherm blue pipe** **aquatherm lilac pipe**

The installation of risers of aquatherm pipes without stabilizing components requires a branch pipe, which is elastic enough to take the linear expansion of the riser.

This can be ensured by a favourable fixing of the riser in the duct (see 2).

An adequate large pipe liner also gives sufficient elasticity to the branch-off pipe (see 3).

Furthermore the installation of a spring leg gives the appropriate elasticity (see 4).

When laying aquatherm pipes through the wall and ceiling, the fire protection must be observed (see pages 26-28).

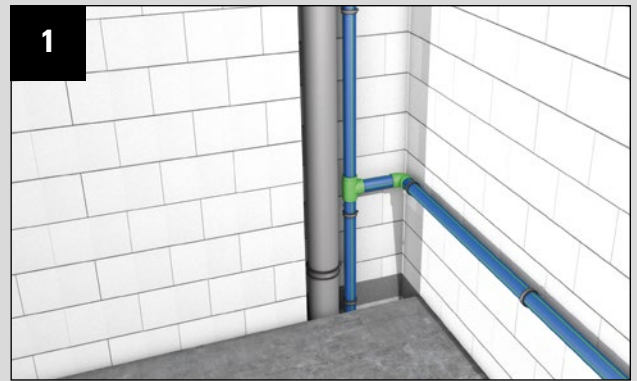

Positioning of the fixed point clamp



Favourable fixing



Large diameter pipe liner



Installation of a spring leg

OPEN INSTALLATION / CALCULATION OF THE LINEAR EXPANSION

Open installation (horizontal)

In case of open installed pipes (e.g. in the basement), excellent optical characteristics and form stability are important. aquatherm pipes for cold water and aquatherm faser composite pipes for hot water and heating plants make this possible. The coefficient (α) of linear expansion of aquatherm composite pipes is only

$$\alpha_{\text{green pipe MS}} = 0,030 \text{ mm/mK}$$

$$\alpha_{\text{green pipe MF}} = 0,035 \text{ mm/mK}$$

and therefore nearly identical with the linear expansion of metal pipes.

The coefficient of linear expansion of aquatherm pipes without stabilizing components is

$$\alpha_{\text{green pipe}} = 0,150 \text{ mm/mK}$$

aquatherm faser composite pipes must have enough space to expand (see below). An expansion control is required for long and straight faser composite pipes (over 40 m).

aquatherm pipes without the stabilizing compound should have the expansion control after 10 m straight pipelines. The following formula, calculation examples, data-tables and diagrams help to determine the linear expansion. The difference between working temperature and maximum or minimum installation temperature is essential for the calculation of linear expansion.

Calculation of the linear expansion

Given and required values

Symbol	Meaning	Value	Measuring unit
ΔL	Linear expansion	?	[mm]
α_2	Coefficient of linear expansion aquatherm faser composite pipe	0,035	mm/mK
α_3	Linear expansion coefficient	0,15	mm/mK
L	Pipe length	25,0	[m]
T_B	Working temperature	60	°C
T_M	Installation temperature	20	°C
ΔT	Temperature difference between working and installation temperature ($\Delta T = T_W - T_M$)	40	K

The linear expansion ΔL is calculated according to the following formula:

$$\Delta L = \alpha \times L \times \Delta T$$

Example:

aquatherm green pipe MF faser composite pipe ($a = 0.035 \text{ mm/mK}$)

$$\Delta L = 0,035 \text{ mm/mK} \times 25,0 \text{ m} \times 40 \text{ K}$$

$$\Delta L = 35,0 \text{ mm}$$

Linear expansion comparison:

faser composite-
to standard PP-pipe

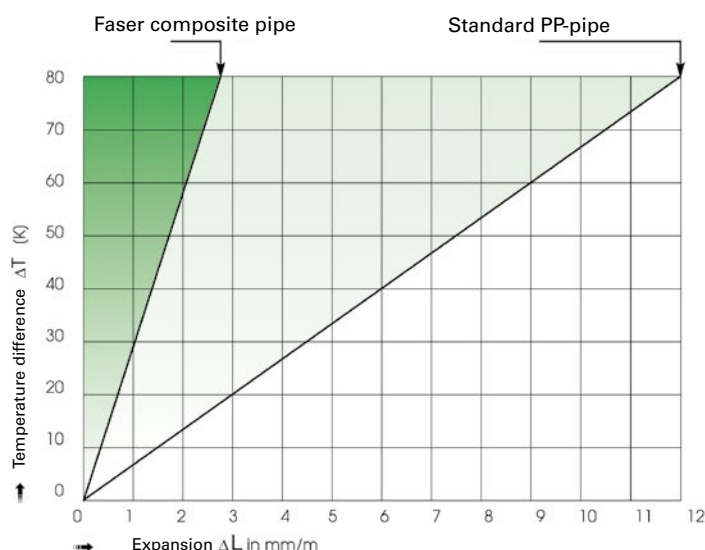

aquatherm green pipe & aquatherm blue pipe
(without faser)

The linear expansion, described on the preceding pages, can be taken from the following tables and graphs.

Linear expansion ΔL in [mm]: green and blue pipe - $\alpha = 0,150$ mm/mK

Pipe length	Difference in temperature $\Delta T = T_{\text{operating temperature}} - T_{\text{installation temperature}}$							
	10 K	20 K	30 K	40 K	50 K	60 K	70 K	80 K
	Linear expansion ΔL (mm)							
5 m	8	15	23	30	38	45	53	60
10 m	15	30	45	60	75	90	105	120
15 m	23	45	68	90	113	135	158	180
20 m	30	60	90	120	150	180	210	240
25 m	38	75	113	150	188	225	263	300
30 m	45	90	135	180	225	270	315	360
35 m	53	105	158	210	263	315	368	420
40 m	60	120	180	240	300	360	420	480
45 m	68	135	203	270	338	405	473	540
50 m	75	150	225	300	375	450	525	600

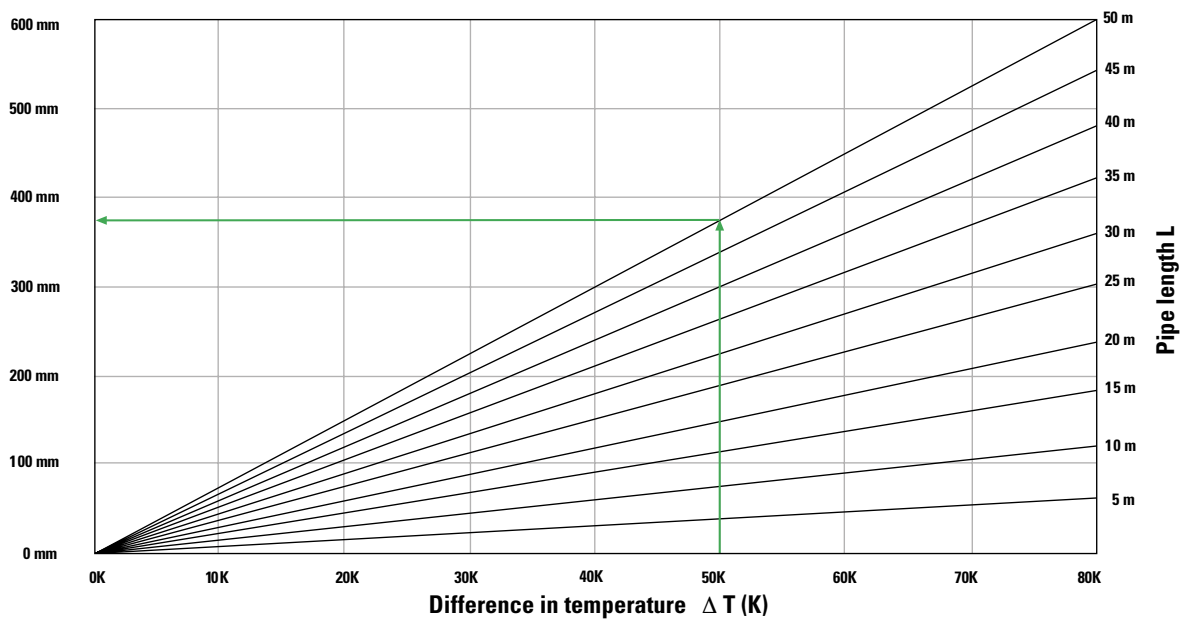

aquatherm green pipe MF (faser composite pipe)
aquatherm blue pipe MF (faser composite pipe)

Due to the integration and positive bond of the different materials, the aquatherm faser composite pipes offers much higher stability. The linear expansion reduces its value to $\frac{1}{5}$ of the mere PP-pipes.

Linear expansion ΔL in [mm]: aquatherm faser composite pipes - $\alpha = 0.035 \text{ mm/mK}$

Pipe length	Difference in temperature $\Delta T = T_{\text{operating temperature}} - T_{\text{installation temperature}}$							
	10 K	20 K	30 K	40 K	50 K	60 K	70 K	80 K
	Linear expansion ΔL (mm)							
10 m	4	7	11	14	18	21	25	28
20 m	7	14	21	28	35	42	49	56
30 m	11	21	32	42	53	63	74	84
40 m	14	28	42	56	70	84	98	112
50 m	18	35	53	70	88	105	123	140
60 m	21	42	63	84	105	126	147	168
70 m	25	49	74	98	123	147	172	196
80 m	28	56	84	112	140	168	196	224
90 m	32	63	95	126	158	189	221	252
100 m	35	70	105	140	175	210	245	280

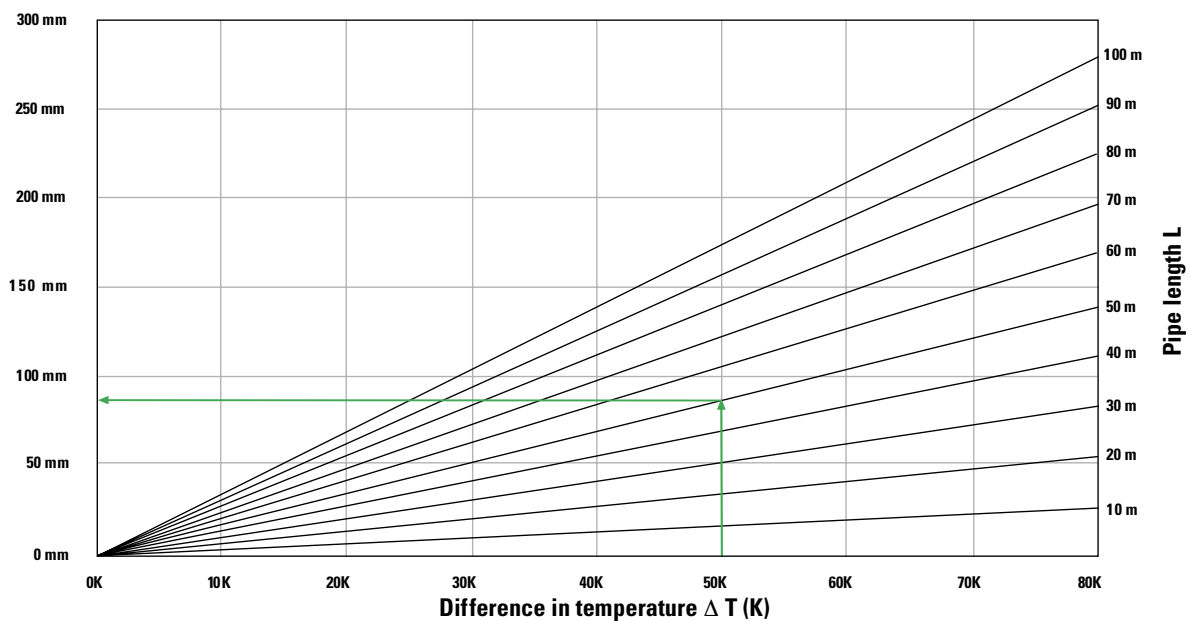

PIPE CLAMPS suitable as fixing point

From now on aquatherm offers fixed-point fastenings for pipes from 160 mm–630 mm (Art. no. 60768–60790). Packing unit is each with 1 piece.

Advantages:

- Reliable and permanent protection against perforation corrosion and breakdown of the static load capacity
- 1000 hours salt spray test without ferric oxide (rust)
- Suitable for installation in corrosive inner and outside areas
- Considerably higher corrosion protection than with electrogalvanized and hot-dip galvanized products (after spread test acc. to DIN EN ISO 9227)

Art. no.	diameter	min. torque clamp locking	min. torque height adjustment	height adjustment	fixig on building	measure „a“	weight per set
[-]	[mm]	[Nm]	[Nm]	[mm]	[-]	[mm]	[kg]
0060768	160	25	75	192,5–283,5	M 12	354,1	8,55
0060770	200	25	75	192,5–283,5	M 12	394,5	9,45
0060774	250	50	75	192,5–283,5	M 12	444,8	19,37
0060778	315	50	75	192,5–283,5	M 12	510	22,75
0060780	355	50	75	192,5–283,5	M 12	550,1	24,84

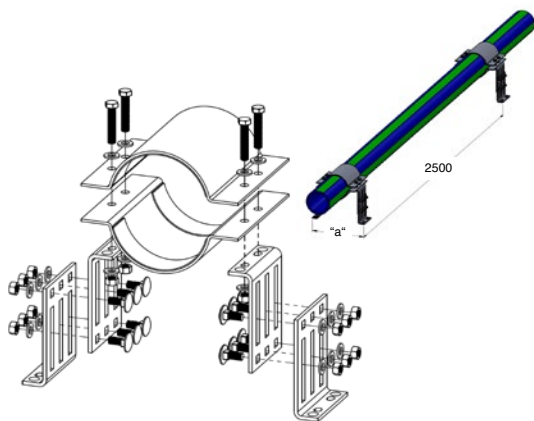

art.-no.	diameter	min. torque clamp locking	min. torque height adjustment	height adjustment	fixig on building	measure „a“	weight per set
[-]	[mm]	[Nm]	[Nm]	[mm]	[-]	[mm]	[kg]
0060782	400	50	120	404,5–497,5	M16	823,2	43,64
0060784	450	50	120	404,5–497,5	M16	873,3	46,25
0060786	500	50	120	404,5–497,5	M16	923,4	48,87
0060788	560	50	120	404,5–497,5	M16	983,4	52,00
0060790	630	50	120	404,5–497,5	M16	1053,5	55,66

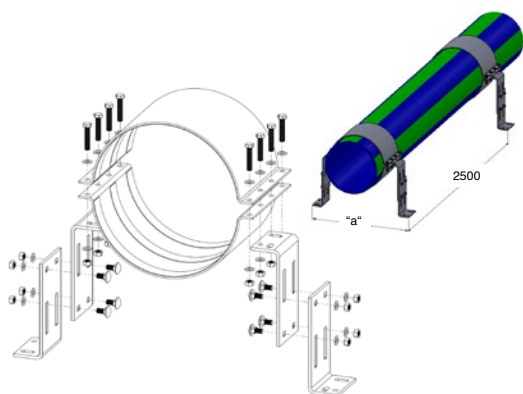

BENDING SIDE

Linear expansion due to temperature difference between operating temperature and installation temperature can be compensated by different installation techniques.

Bending side

In most cases direction changes can be used to compensate for linear expansion in pipes.

The values of the bending side can be taken directly from the tables and graphs on the following pages.

Symbol	Meaning	
L_{BS}	Length of the bending side	[mm]
K	Material specific constant	15,0
d	Outside diameter	[mm]
ΔL	Linear expansion	[mm]
L	Pipe Length	[m]
FP	Fixed point	
GP	Sliding point	

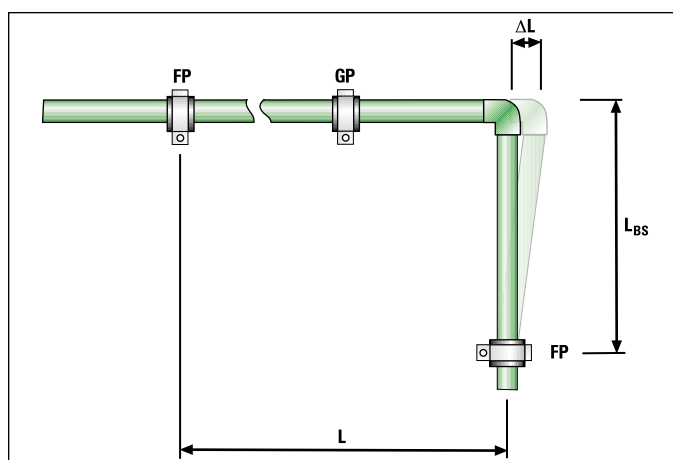

Calculational determination of the bending side length

$$L_{BS} = K \times \sqrt{d \times \Delta L}$$

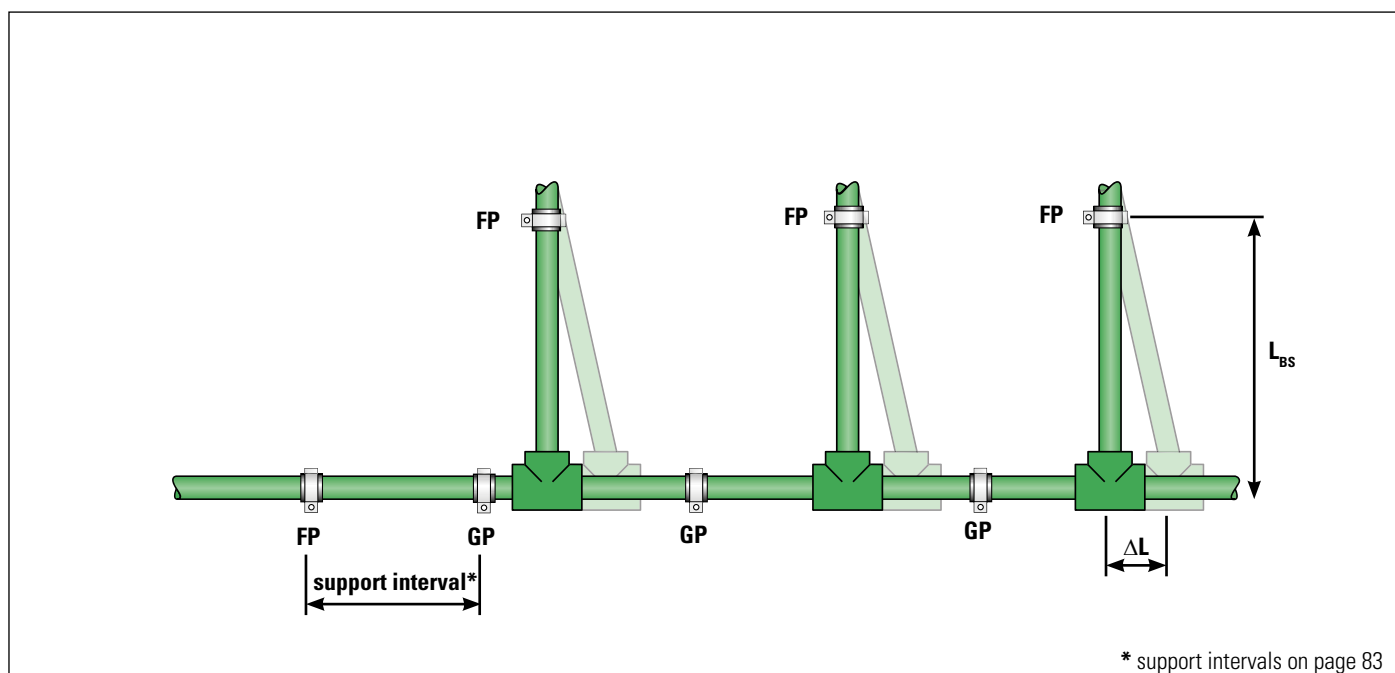

* support intervals on page 83

PRE-STRESS / BELLOW EXPANSION JOINT
Expansion loop

If the linear expansion cannot be compensated by a change in direction, it will be necessary to install an expansion loop with long and straight pipelines.

In addition to the length of the bending side L_{BS} the width of the pipe bend A_{min} must be considered.

Symbol	Meaning	
A_{min}	Width of the expansion loop	[mm]
SA	Safety distance	150 mm

The pipe bend A_{min} is calculated acc. to the following formula:

$$A_{min} = 2 \times \frac{\Delta L}{2} + SA$$

The width of the expansion loop A_{min} should be at least 210 mm.

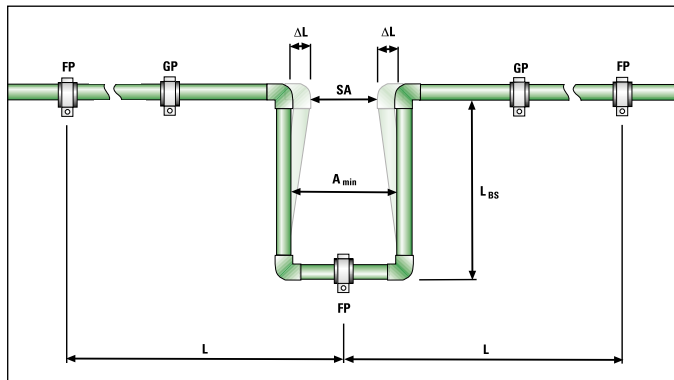

Determination size of expansion loop

Example

Specification: Pipeline, length 80 m (MF pipe)

Determined expansion: $112 \text{ mm} = (\Delta L = \frac{0,035 \text{ mm}}{\text{mK}} \times 80 \text{ m} \times 40 \text{ K})$

The expansion loop should be installed exactly in the center of the pipe.

Calculation:

Given: $\Delta L = 112 \text{ mm}$
 $SA = 150 \text{ mm}$

Formula:

$$A_{min} = 2 \times \frac{\Delta L}{2} + SA$$

$$A_{min} = 2 \times \frac{112 \text{ mm}}{2} + 150 \text{ mm}$$

$$A_{min} = 262 \text{ mm}$$

The width of the expansion loop should be 262 mm in this example.

Pre-stress

Where space is limited, it is possible to shorten the total width A_{min} as well as the length of the bending side L_{BSV} by pre-stressing.

Pre-stress installations, if planned and carried out carefully, offer an optically perfect installation, as the linear expansion is hardly visible.

Symbol	Meaning	
L_{BSV}	Length of pre-stress	[mm]

The side length of expansion loops with pre-stress is calculated acc. to the following example:

$$L_{BSV} = K \times \sqrt{d \times \frac{\Delta L}{2}}$$

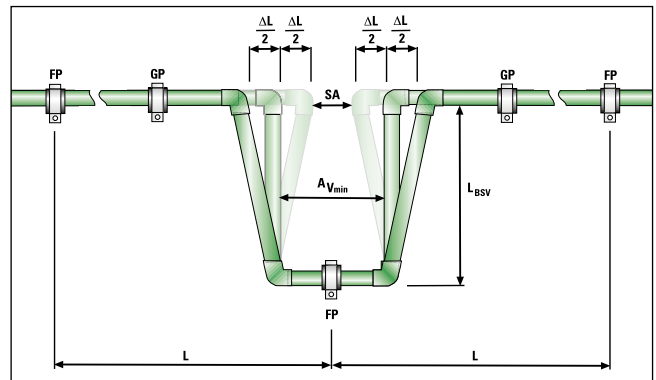

Below expansion joint

All bellow expansion joints for corrugated pipes designed for metal materials are unsuitable for aquatherm PP-R-pipes.

When using axial expansion joints observe the manufacturers instructions.

LENGTH OF BENDING SIDE

for aquatherm PP-R-pipes – the length of the bending side with pre-stress L_{BSV} can be taken from the tables and graphs in consideration of the applied pipe dimensions and determined linear expansion.

Pipe Dimension	Linear expansion (mm)											
	10	20	30	40	50	60	70	80	90	100	110	120
	Length of bending side (m)											
20 mm	0,21	0,30	0,37	0,42	0,47	0,52	0,56	0,60	0,64	0,67	0,70	0,73
25 mm	0,24	0,34	0,41	0,47	0,53	0,58	0,63	0,67	0,71	0,75	0,79	0,82
32 mm	0,27	0,38	0,46	0,54	0,60	0,66	0,71	0,76	0,80	0,85	0,89	0,93
40 mm	0,30	0,42	0,52	0,60	0,67	0,73	0,79	0,85	0,90	0,95	0,99	1,04
50 mm	0,34	0,47	0,58	0,67	0,75	0,82	0,89	0,95	1,01	1,06	1,11	1,16
63 mm	0,38	0,53	0,65	0,75	0,84	0,92	1,00	1,06	1,13	1,19	1,25	1,30
75 mm	0,41	0,58	0,71	0,82	0,92	1,01	1,09	1,16	1,23	1,30	1,36	1,42
90 mm	0,45	0,64	0,78	0,90	1,01	1,10	1,19	1,27	1,35	1,42	1,49	1,56
110 mm	0,50	0,70	0,86	0,99	1,11	1,22	1,32	1,41	1,49	1,57	1,65	1,72
125 mm	0,53	0,75	0,92	1,06	1,19	1,30	1,40	1,50	1,59	1,68	1,76	1,84
160 mm	0,60	0,85	1,04	1,20	1,34	1,47	1,59	1,70	1,80	1,90	1,99	2,08
200 mm	0,67	0,95	1,16	1,34	1,50	1,64	1,77	1,90	2,01	2,12	2,22	2,32
250 mm	0,75	1,06	1,30	1,50	1,68	1,84	1,98	2,12	2,25	2,37	2,49	2,60
315 mm	0,84	1,19	1,46	1,68	1,88	2,06	2,23	2,38	2,53	2,66	2,79	2,92
355 mm	0,89	1,26	1,55	1,79	2,00	2,19	2,36	2,53	2,68	2,83	2,96	3,10
400 mm	0,95	1,34	1,64	1,90	2,12	2,32	2,51	2,68	2,85	3,00	3,15	3,29
450 mm	1,01	1,42	1,74	2,01	2,25	2,46	2,66	2,85	3,02	3,18	3,34	3,49
500 mm	1,06	1,50	1,84	2,12	2,37	2,60	2,81	3,00	3,18	3,35	3,52	3,67
560 mm	1,12	1,59	1,94	2,24	2,51	2,75	2,97	3,17	3,37	3,55	3,72	3,89
630 mm	1,19	1,68	2,06	2,38	2,66	2,92	3,15	3,37	3,57	3,76	3,95	4,12

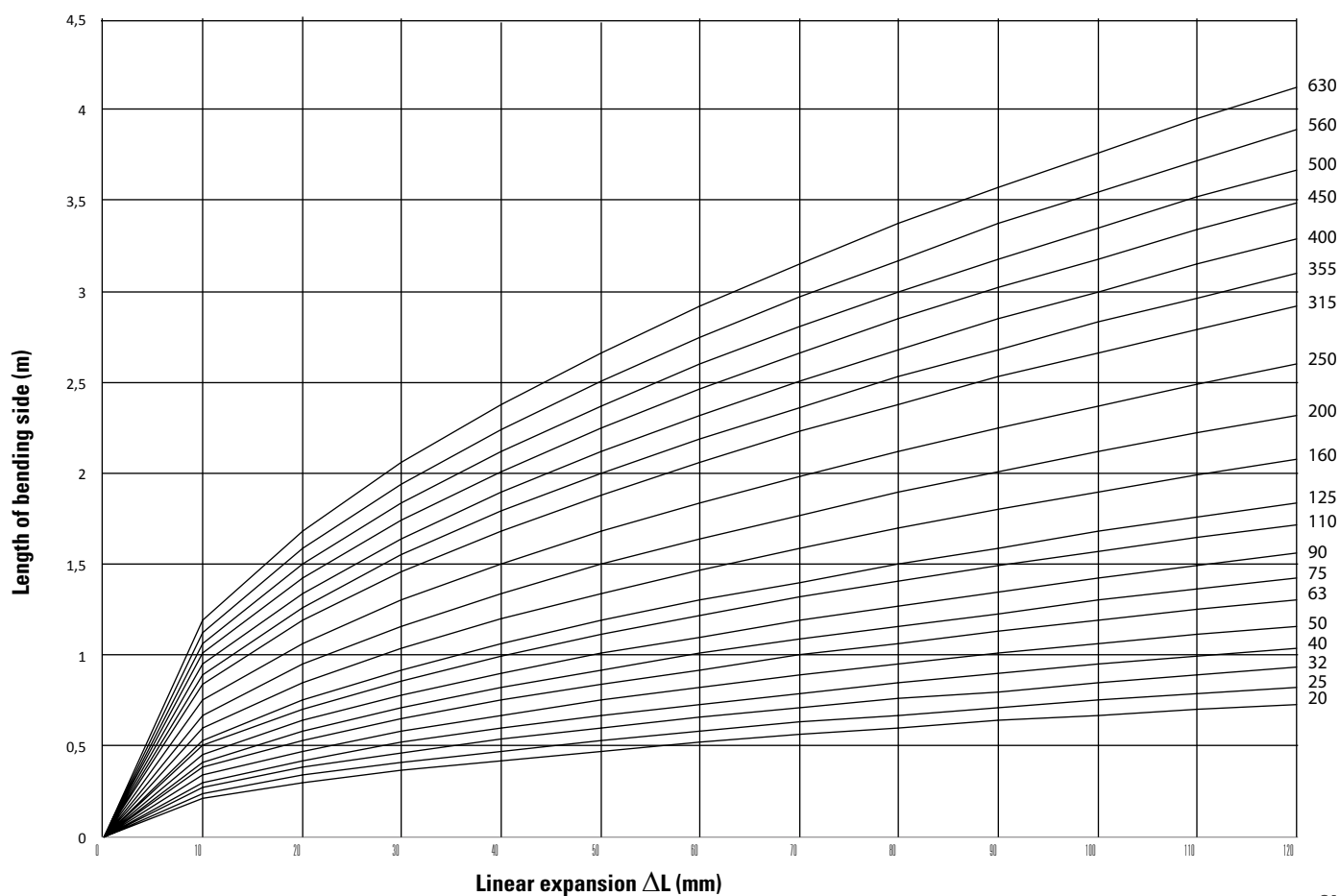

LENGTH OF BENDING SIDE WITH PRE-STRESS

For aquatherm PP-R-pipes – the length of the bending side with pre-stress L_{BSV} can be taken from the tables and graphs in consideration of the applied pipe dimensions and determined linear expansion.

Pipe Dimension	Linear expansion (mm)											
	10	20	30	40	50	60	70	80	90	100	110	120
	Length of bending side (m)											
20 mm	0,15	0,21	0,26	0,30	0,34	0,37	0,40	0,42	0,45	0,47	0,50	0,52
25 mm	0,17	0,24	0,29	0,34	0,38	0,41	0,44	0,47	0,50	0,53	0,56	0,58
32 mm	0,19	0,27	0,33	0,38	0,42	0,46	0,50	0,54	0,57	0,60	0,63	0,66
40 mm	0,21	0,30	0,37	0,42	0,47	0,52	0,56	0,60	0,64	0,67	0,70	0,73
50 mm	0,24	0,34	0,41	0,47	0,53	0,58	0,63	0,67	0,71	0,75	0,79	0,82
63 mm	0,27	0,38	0,46	0,53	0,60	0,65	0,70	0,75	0,80	0,84	0,88	0,92
75 mm	0,29	0,41	0,50	0,58	0,65	0,71	0,77	0,82	0,87	0,92	0,96	1,01
90 mm	0,32	0,45	0,55	0,64	0,71	0,78	0,84	0,90	0,95	1,01	1,06	1,10
110 mm	0,35	0,50	0,61	0,70	0,79	0,86	0,93	0,99	1,06	1,11	1,17	1,22
125 mm	0,38	0,53	0,65	0,75	0,84	0,92	0,99	1,06	1,13	1,19	1,24	1,30
160 mm	0,42	0,60	0,73	0,85	0,95	1,04	1,12	1,20	1,27	1,34	1,41	1,47
200 mm	0,47	0,67	0,82	0,95	1,06	1,16	1,25	1,34	1,42	1,50	1,57	1,64
250 mm	0,53	0,75	0,92	1,06	1,19	1,30	1,40	1,50	1,59	1,68	1,76	1,84
315 mm	0,60	0,84	1,03	1,19	1,33	1,46	1,58	1,68	1,79	1,88	1,97	2,06
355 mm	0,63	0,89	1,09	1,26	1,41	1,55	1,67	1,79	1,90	2,00	2,10	2,19
400 mm	0,67	0,95	1,16	1,34	1,50	1,64	1,77	1,90	2,01	2,12	2,22	2,32
450 mm	0,71	1,01	1,23	1,42	1,59	1,74	1,88	2,01	2,13	2,25	2,36	2,46
500 mm	0,75	1,06	1,30	1,50	1,68	1,84	1,98	2,12	2,25	2,37	2,49	2,60
560 mm	0,79	1,12	1,37	1,59	1,77	1,94	2,10	2,24	2,38	2,51	2,63	2,75
630 mm	0,84	1,19	1,46	1,68	1,88	2,06	2,23	2,38	2,53	2,66	2,79	2,92

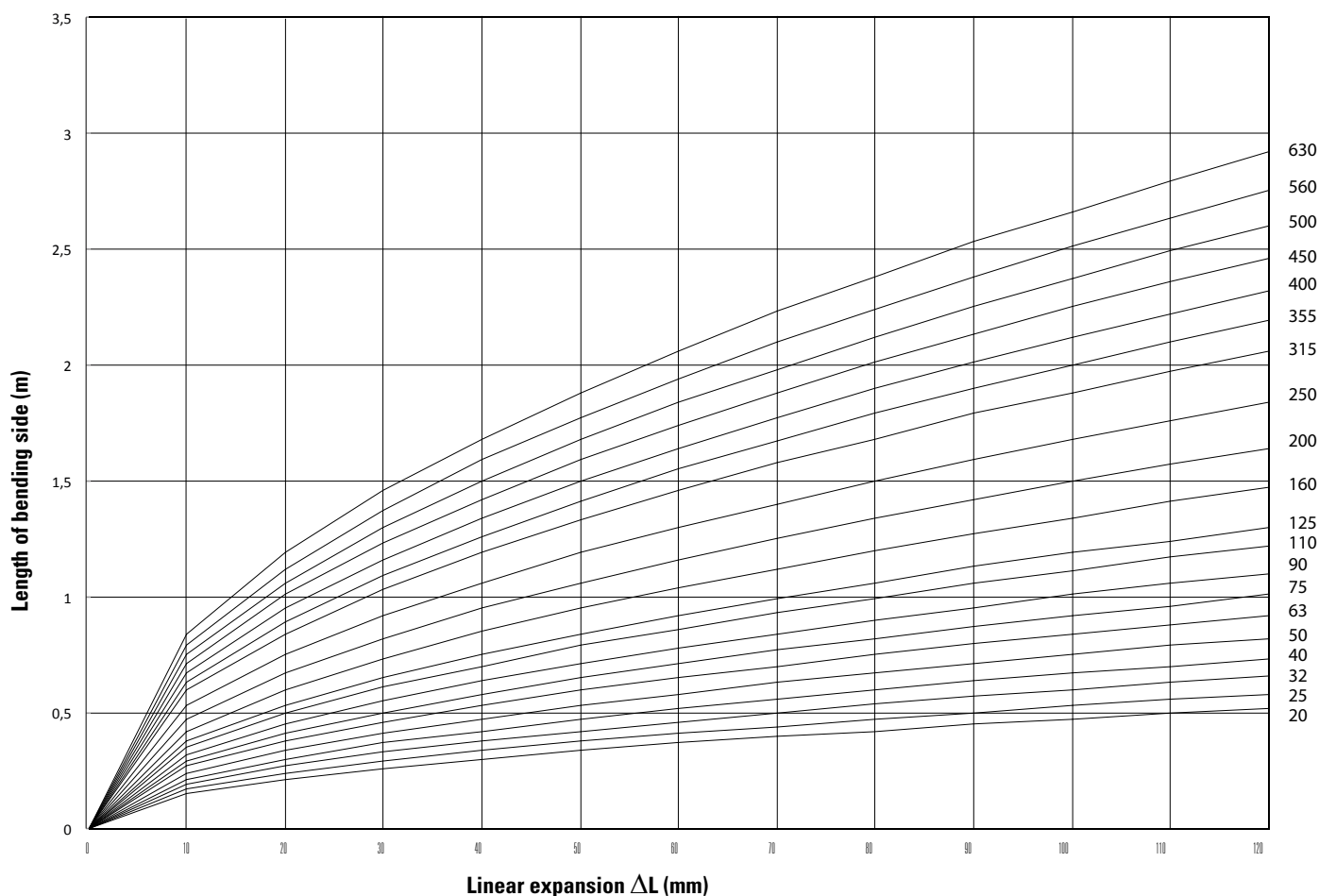

SUPPORT INTERVALS

aquatherm green pipe SDR 6 S & aquatherm lilac pipe SDR 7.4 S

Table to determine support intervals in conjunction with temperature and outside diameter.

Difference in temperature ΔT [K]	Pipe diameter d (mm)									
	16	20	25	32	40	50	63	75	90	110
	Support intervals in cm									
0	70	85	105	125	140	165	190	205	220	250
20	50	60	75	90	100	120	140	150	160	180
30	50	60	75	90	100	120	140	150	160	180
40	50	60	70	80	90	110	130	140	150	170
50	50	60	70	80	90	110	130	140	150	170
60	50	55	65	75	85	100	115	125	140	160
70	50	50	60	75	80	95	105	115	125	140

aquatherm green pipe, aquatherm blue pipe & aquatherm lilac pipe SDR 11 S

Table to determine support intervals in conjunction with temperature and outside diameter.

Pipe diameter d (mm)														
20	25	32	40	50	63	75	90	110	125	160	200	250	315	355
Support intervals in cm														
60	75	90	100	120	140	150	160	180	200	260	265	275	280	285

aquatherm blue pipe SDR 17.6 MF

Table to determine support intervals in conjunction with temperature and outside diameter.

Difference in temperature ΔT [K]	Pipe diameter d (mm)											
	125	160	200	250	315	355	400	450	500	560	630	
	Support intervals in cm											
0	255	260	265	275	280	285	295	305	315	325	330	
20	185	190	200	205	210	215	230	240	255	270	280	
30	175	180	190	195	200	205	220	230	245	260	275	
40	170	175	180	190	190	195	210	225	235	250	265	
50	160	165	175	180	185	190	200	215	230	240	255	
60	150	155	165	170	175	180	185	200	215	230	240	
70	140	145	155	160	170	175	180	190	205	220	230	

SUPPORT INTERVALS

aquatherm green pipe SDR 7.4 MF & aquatherm blue pipe SDR 7.4 MF (faser composite pipes)

Table to determine support intervals in conjunction with temperature and outside diameter.

Difference in temperature ΔT [K]	Pipe diameter d (mm)		
	20	25	32
	Support intervals in cm		
0	120	140	160
20	90	105	120
30	90	105	120
40	85	95	110
50	85	95	110
60	80	90	105
70	70	80	95

Pipe clamp distances of vertically installed pipes can be increased by 20 % of the tabular values, e.g. to multiply the tabular value by 1.2.

aquatherm green pipe SDR 9 MF RP (faser composite pipe)

Table to determine support intervals in conjunction with temperature and outside diameter.

Difference in temperature ΔT [K]	Pipe diameter d (mm)													
	32	40	50	63	75	90	110	125	160	200	250	315	355	
	Support intervals in cm													
0	155	175	200	225	240	255	285	300	310	315	325	335	340	
20	115	130	150	170	180	190	210	225	225	240	245	250	255	
30	115	130	150	170	180	190	200	210	215	225	230	240	245	
40	105	120	140	160	170	180	190	200	205	215	225	225	230	
50	105	120	140	160	170	180	180	185	195	205	215	220	220	
60	100	115	130	150	160	170	170	175	185	195	200	205	210	
70	90	105	125	140	155	155	160	165	175	185	190	200	205	

Pipe clamp distances of vertically installed pipes can be increased by 20 % of the tabular values, e.g. to multiply the tabular value by 1.2.

aquatherm blue pipe SDR 11 MF & aquatherm green pipe SDR 11 MF (faser composite pipes)

Table to determine support intervals in conjunction with temperature and outside diameter.

Difference in temperature ΔT [K]	Pipe diameter d (mm)															
	32	40	50	63	75	90	110	125	160	200	250	315	355	400	450	
	Support intervals in cm															
0	150	170	195	220	235	250	275	280	285	290	300	310	315	325	325	
20	110	125	145	165	175	185	200	205	210	220	225	230	235	250	265	
30	110	125	145	165	175	185	190	195	200	210	215	220	225	240	255	
40	100	115	135	155	165	175	180	185	190	200	210	210	215	230	245	
50	100	115	135	155	160	170	170	175	180	190	200	205	205	220	235	
60	95	110	125	145	150	160	160	165	170	180	185	190	195	205	220	
70	85	100	120	135	140	145	150	155	160	170	175	185	190	195	210	

Pipe clamp distances of vertically installed pipes can be increased by 20 % of the tabular values, e.g. to multiply the tabular value by 1.2.

THERMAL INSULATION OF HOT WATER PIPES

minimum insulation thickness in [mm] against condensation

Medium temperature 5°C – thermal conductivity value of insulation 0,040 W/mK												
Dimension	humidity	ambient temperature										
		20°C	22°C	24°C	26°C	28°C	30°C	32°C	34°C	36°C	38°C	40°C
75 mm	50 %		1	1	2	2	3	3	4	4	5	5
	60 %	2	3	3	4	5	5	6	7	7	8	8
	70 %	5	6	7	8	8	9	10	11	12	13	13
	80 %	9	11	12	14	15	17	18	19	20	21	22
110 mm	50 %				1	2	2	3	3	4	4	4
	60 %	1	2	3	3	4	5	5	6	7	7	8
	70 %	4	5	6	7	8	9	10	10	11	12	13
	80 %	9	11	12	14	15	17	18	19	20	21	22
160 mm	50 %						1	1	2	2	3	3
	60 %		1	1	2	3	4	4	5	5	6	7
	70 %	3	4	5	6	7	8	9	9	11	11	12
	80 %	8	10	11	13	14	16	17	19	20	21	22

The decree for energy saving thermal protection and energy saving technique for buildings Decree for Energy Saving (EnEV) regulates the thermal insulation of hot water supplies and fittings in Germany.

Central heating pipes, line 1–4 installed in heated rooms or building parts between heated rooms of the one user, where heat output can be controlled by open stop valves do not require a minimum thickness of the insulation.

This even applies to hot water pipes up to an inner diameter of 22 mm in flats, which are neither in the circulation nor have an additional electric heating.

Applying material with thermal conductivities different to 0.035 W/(mK) the minimum thickness of the insulation has to be converted correspondingly.

For the conversion and the thermal conductivity of the insulation the ways and values of calculation described in the technical regulations must be applied.

The minimum insulation acc. to the table for heating distributions and heating pipes can be reduced as far as the same limit of heat output even for further insulation requirements in consideration of the insulating effect of the pipe walls are guaranteed.

Cooling pipes must be provided with suitable insulation to prevent condensation. For further information please contact our service hotline +49 2722 950-200

EnEV 2009, § 14, addendum 5, chart 1

Line	Type of pipe/fitting	minimum thickness of insulation referred to thermal conductivity of 0.035 W/(mK)
1	inner diameter up to 22 mm	20 mm
2	inner diameter more than 22 mm up to 35 mm	30 mm
3	inner diameter more than 35 mm up to 100 mm	same as inner diameter
4	inner diameter more than 100 mm	100 mm
5	pipes and fittings after line 1–4 in wall- and ceiling openings, in crossing area of pipes, at pipe connections, at distributors	½ of the requirements of line 1 to 4
6	pipes of central heating after line 1–4, which have been installed after introduction of this decree between heated rooms of various users	½ of the requirements of line 1 to 4
7	pipes after line 6 in floor construction	6 mm
8	Cooling distribution and cold water pipes and fittings of air handling and air conditioning systems	6 mm

INSULATION THICKNESS ACC. TO DECREE FOR ENERGY SAVING

Acc. to this decree aquatherm PP-R-pipes and fittings have to be insulated against loss of heat. The insulation thickness depends on the respective installation.

The heat conductivity figure of fusiolen® PP-R is 0.15 W/(mK) aquatherm PP-R-pipes and fittings offer a significantly higher degree of insulation compared to metal pipes.

Due to the high insulation values of the pipe-material PP-R the insulation thickness – compared to metallic pipe systems – can be reduced.

Undermentioned are the recommendation based on EnEV 2009. Regional standards might vary and are to be considered.

Thermal insulation from heat distribution and hot water pipes, cooling distribution and cold water pipes acc. EnEV 2009

Minimum thickness of insulation referred to thermal conductivity of 0.035 W/(mK)

pipe diameter	50 %	100 %
16 mm	10 mm	20 mm
20 mm	10 mm	20 mm
25 mm	10 mm	20 mm
32 mm	15 mm	30 mm
40 mm	15 mm	30 mm
50 mm	18 mm	35 mm
63 mm	23 mm	45 mm
75 mm	28 mm	55 mm
90 mm	33 mm	65 mm
110 mm	40 mm	80 mm
125 mm	45 mm	90 mm
160 mm	50 mm	100 mm
200 mm	50 mm	100 mm
250 mm	50 mm	100 mm
315 mm	50 mm	100 mm
355 mm	50 mm	100 mm
400 mm	50 mm	100 mm
450 mm	50 mm	100 mm
500 mm	50 mm	100 mm
560 mm	50 mm	100 mm
630 mm	50 mm	100 mm

* The insulation thickness has to be calculated due to the thermal conductivity of polypropylene pipes acc. to test report no.: G.2 - 136/97 of FIW-Munich

PRESSURE TEST/TEST CONTROL/ MEASURING OF THE TEST PRESSURES/TEST RECORD

Pressure test/Test control

All aquatherm pipe systems shall be subjected to a hydraulic pressure test with a test-pressure of 10 bar.

The material properties of the aquatherm pipe systems result in an expansion of the pipes during the pressure test. This affects the test result. Due to the thermal expansion coefficients of the aquatherm pipe systems the results are influenced additionally. The temperature differences between the pipe and the test medium lead to changes in pressure. Hereby a temperature change of 10 K corresponds to a pressure difference of 0,5 up to 1 bar.

Therefore pressure testing of the aquatherm pipe systems should be made with a constant temperature of the test medium. The hydraulic pressure test requires a preliminary, principal and final test.

In the preliminary test a pressure of **18 bar*** is applied 3 x 5 minutes for the expansion/release of the pipes. Between the cycles the pipe system must be depressurized.

Immediately after the preliminary test the principal test should be performed. The test duration is 15 min. Here, the test pressure (10 bar) may not fall more than 0,5 bar.

After completion of the preliminary and principle test finally the final test must be performed.

The test duration is 60 minutes. Here, the test pressure – read after the principle test – may not fall more than 0,5 bar.

Measuring of the test pressures

A mechanical (U tube or Bourdon gauge) manometer is to be used for the measurement. The manometer has to be placed at the deepest point of the installation. Digital manometers are not suitable for the aquatherm blue pipe.

Test record

A record of the hydraulic pressure test has to be prepared and signed by the client and contractor stating place and date (see page 89).

*** Exception: aquatherm blue pipe SDR 17.6: 10 bar**

LEAKAGE TEST/PRESSURE DIAGRAM

PRELIMINARY TEST

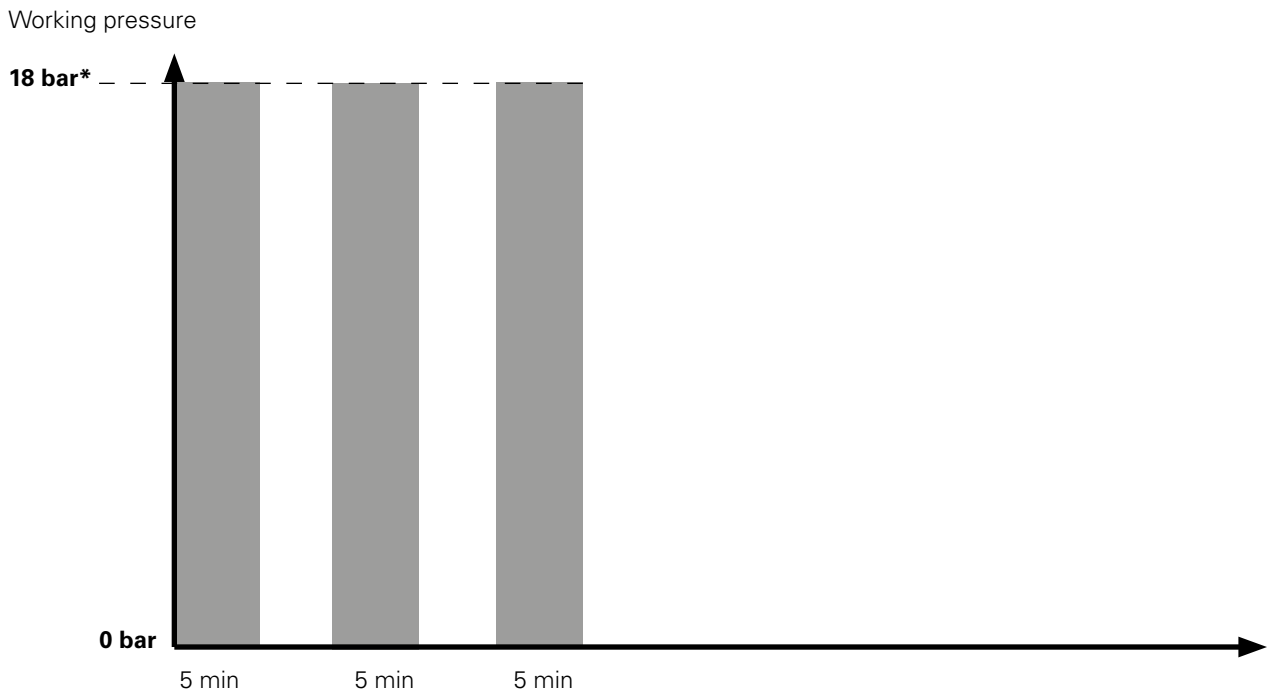

PRINCIPAL- AND FINAL TEST

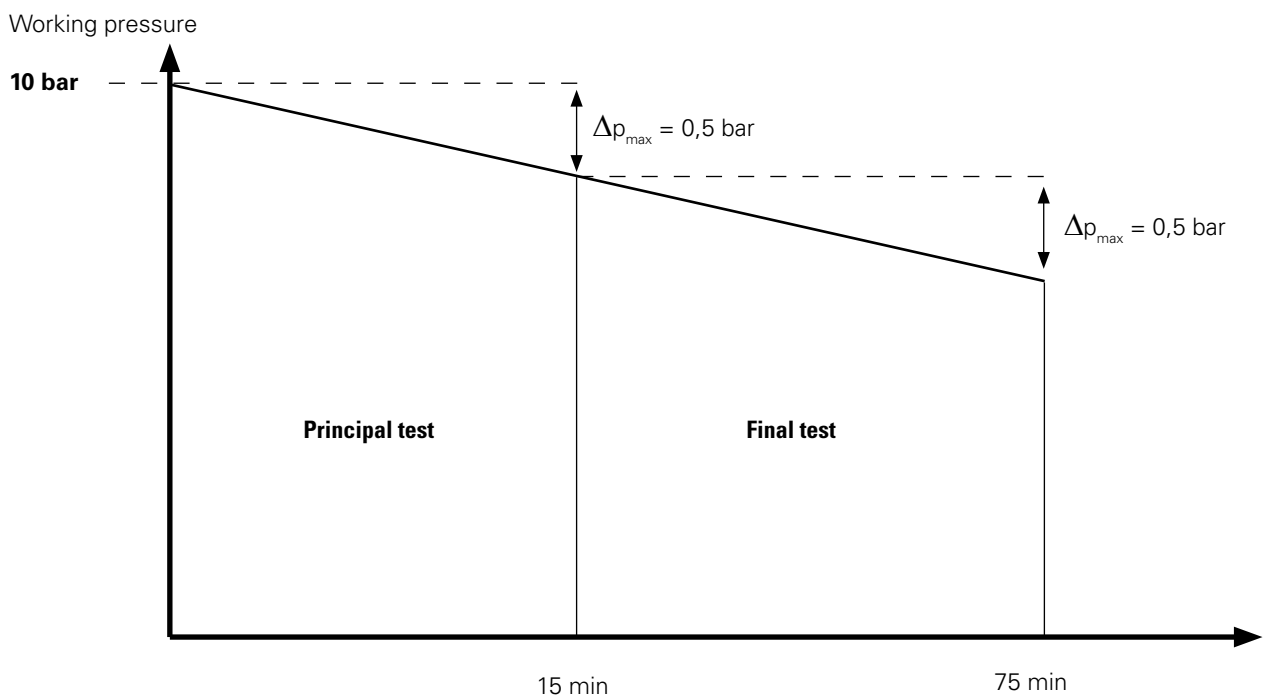

* Exception: aquatherm blue pipe SDR 17.6: 10 bar

TEST RECORD AQUATHERM SYSTEM INSTALLATION

Place: _____

Object: _____

Note before the test:

3 x 5 minutes system pressure of 18 bar or 10 bar for expansion/release of the pipes are required.

Preliminary test for SDR 6, SDR 7,4 and SDR 11

The pipe system must be unpressurized between each cycle.

18 bar 5 min realized: yes no

18 bar 5 min realized: yes no

18 bar 5 min realized: yes no

Preliminary test for SDR 17,6

The pipe system must be unpressurized between each cycle.

10 bar 5 min realized: yes no

10 bar 5 min realized: yes no

10 bar 5 min realized: yes no

Principal test

Test pressure: **10** bar

Pressure decline after 15 min: _____ bar **max. 0,5 bar**

Final test

(directly after the principal test, without changing the pressure)

Result principal test: _____ bar

Pressure decline after 60 min: _____ bar **max. 0,5 bar**

Notes: _____

Place, Date

Stamp/Signature

Description of installation

Place: _____

Object: _____

Pipe length:

Ø 20 mm	_____	m	Ø 160 mm	_____	m
Ø 25 mm	_____	m	Ø 200 mm	_____	m
Ø 32 mm	_____	m	Ø 250 mm	_____	m
Ø 40 mm	_____	m	Ø 315 mm	_____	m
Ø 50 mm	_____	m	Ø 355 mm	_____	m
Ø 63 mm	_____	m	Ø 400 mm	_____	m
Ø 75 mm	_____	m	Ø 450 mm	_____	m
Ø 90 mm	_____	m	Ø 500 mm	_____	m
Ø 110 mm	_____	m	Ø 560 mm	_____	m
Ø 125 mm	_____	m	Ø 630 mm	_____	m

Start of test: _____

End of test: _____

Testperiod: _____

Test medium: water water/glycol

Client: _____

Contractor: _____

Place: _____

Date: _____

Stamp/Signature

FLUSHING OF PIPES / EARTH WIRE / TRANSPORT AND STORAGE

Flushing of pipes

The technical rule for potable water installations (TRWI)

DIN 1988, Part 2

includes a paragraph about the flushing of pipes, which has to be carried out with an air-water-mixture under pressure.

Basically all potable water plants, independent of their material, have to be flushed thoroughly after their installation. The following requirements have to be complied with before the installation can be put into service:

- Protection of the potable water quality
- Avoidance of corrosion damage
- Avoidance of malfunctions of armatures and apparatus.
- Cleanliness of the inner surface of the pipe

These requirements are met by

- Flushing with water
- Flushing with air-water-mixture

On choosing the type of flushing required, the experiences of the installer, the requirements of the client and the instructions of the system manufacturer have to be observed.

For potable water installations acc. to DIN 1988, the aquatherm green pipe system complies with, "1 – flushing with water" is sufficient.

The aquatherm green pipe system complies with DIN 1988 for potable water installations. Thus, flushing with water is sufficient, acc. to procedure 1 stipulated therein.

For this reason it is sufficient to flush the installation with water only.

Earth wire

DIN VDE 0100, Part 701 contains safety measures for rooms containing baths or showers. Among other aspects, this standard regulates the potential balance for such rooms.

The standard stipulates that all conductive components such as metal baths and shower trays, metal outlet valves, metal stench traps and metal pipe systems (e. g. drinking water and heating pipe systems) must be connected to each other.

The connection to an earth conductor must be provided, at a central point, e.g. in the building's mini-distributors installation (power circuit distributors).

Information on renovating potable drinking water pipe systems using aquatherm green pipes:

Where metal pipes are replaced by aquatherm green pipes, the potential balance can not be created by the water pipes.

It should be ensured that the potential balance is checked out by a qualified electrician.

Transport and storage

aquatherm PP-R-pipes may be stored outside at any temperature. A solid base for the pipe is very important to avoid a deformation of the pipes while in transport and storage.

At temperatures below 0 °C it is possible to damage the pipes through strong impacts. The material has to be treated with caution at low temperatures.

In spite of its high resistance aquatherm pipes should be treated with care.

UV-radiation has effects on all high polymer plastics. Do not store permanently outdoor. Maximum storage time (outdoor) is 6 months.



WATER POINT CONNECTIONS

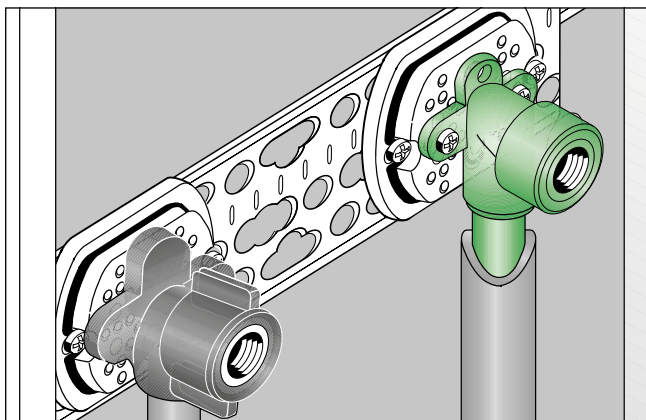

aquatherm green pipe back plate elbow for twin water point connections with galvanized mounting plate and sound insulation plate (Art. no. 79080) from the fixing program (gauge for bore holes 220-153-80 mm)

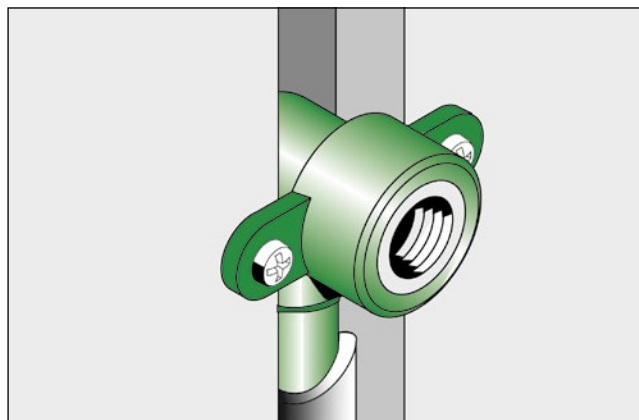

aquatherm green pipe back plate elbow for dry construction installed in a pipe chase

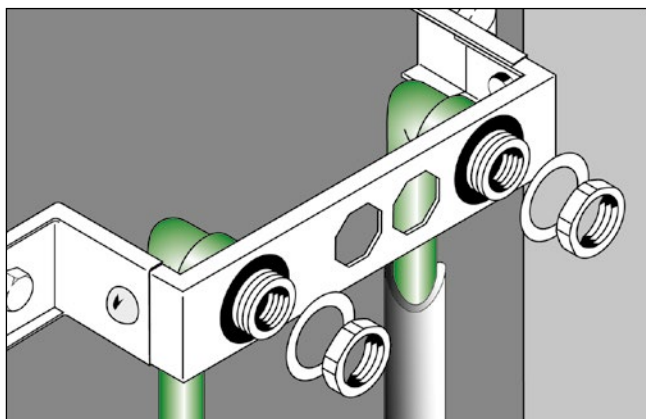

Mounting unit twin (gauge for bore holes 80-100-150 mm) incl. 2 aquatherm green pipe transition elbows female/male with counter nut, gasket and spring washer

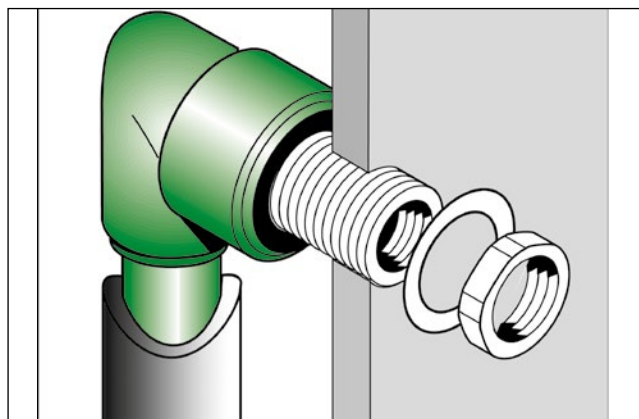

aquatherm green pipe transition elbow female/male for dry construction with 30 mm thread

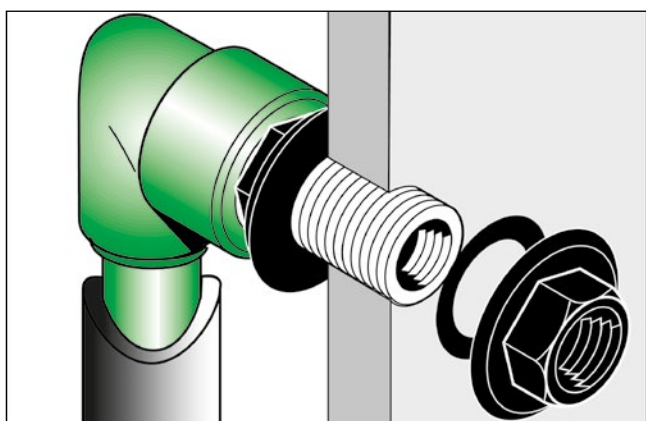

aquatherm green pipe dry construction wall fitting with transition elbow

The aquatherm green pipe transition elbow with female/male thread is suitable for flushing box connections. This transition elbow is also available with a single mounting unit.

**DISTRIBUTION BLOCK:
EXAMPLE OF APPLICATIONS**

Example of applications

The stamped numbers 1 and 2 indicate the proper connection of the aquatherm green pipe distribution block. They provide assistance with the installation.

In case of the "heating" connection variant (top A), the return is connected to the supply channel marked 1 and the flow to supply channel marked 2. The connections can also be used reverse.

In potable water connection variant (top B), supply channel 1 is intended for the cold water pipe and supply channel 2 for the hot water pipe connection. In as-delivered condition, the lower outlets are closed. The connection with supply channel 2 is made by drilling out (18 mm drill bit). Thus an additional pipe can be connected.

By turning the aquatherm green pipe distribution block a mirror-image connection can be made. These variants are presented in the illustrations C and D.

The flow and return connections of the aquatherm green pipe distribution block heating are installed with Ø 20 mm pipes. For radiator connections Ø 16 mm pipes have to be welded into the outflow sockets of the distribution block.

The aquatherm green pipe distribution block plumbing has to be connected with Ø 25 mm pipes. For pipe connections to the taps, Ø 20 mm pipes have to be welded into the outflow sockets of the distribution block.

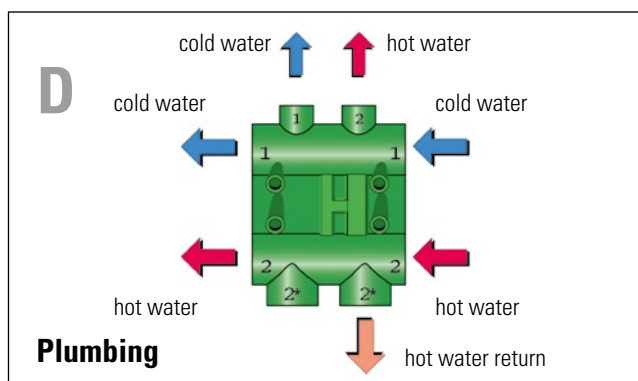
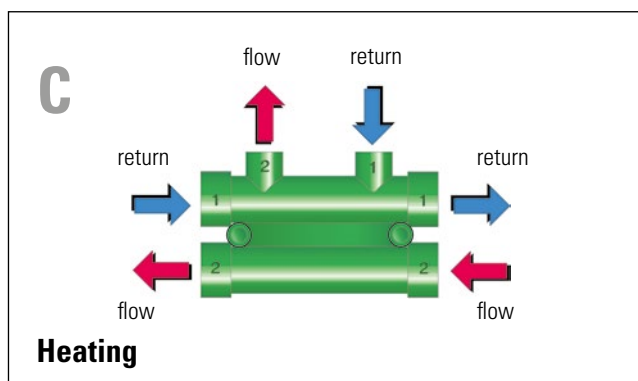
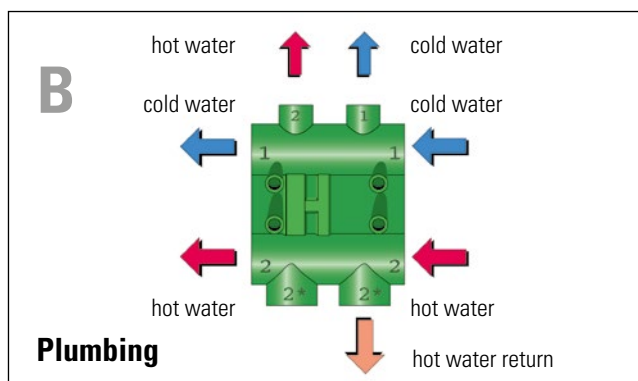
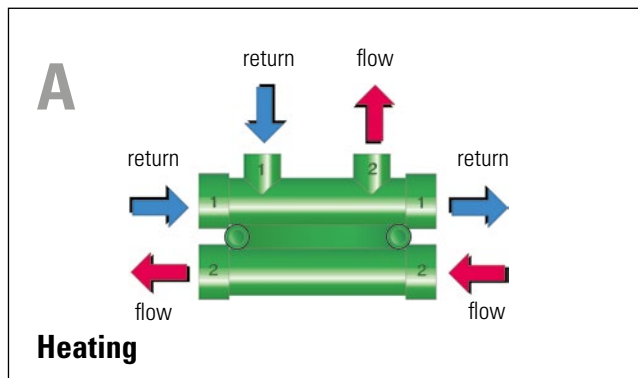

DISTRIBUTION BLOCK:

EXAMPLE OF APPLICATIONS – POTABLE WATER

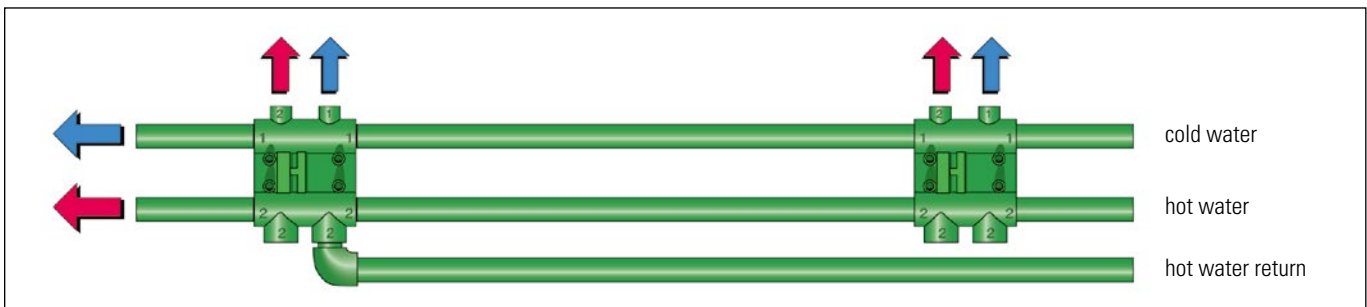

The connection pipes in the individual floors or risers are connected for hot and cold water with aquatherm PP-R-pipes with an external diameter of 25 mm. The same applies for also for the hot water return which can be led back from any aquatherm green pipe distribution block.

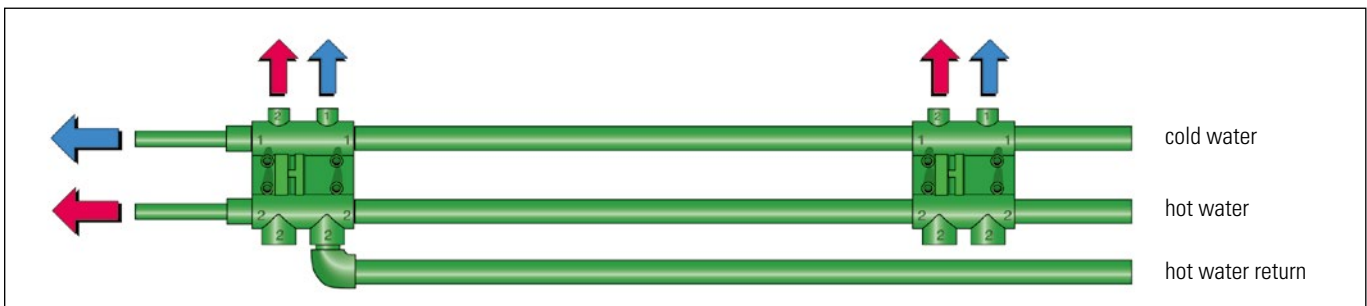

Reducers for further pipe systems can be welded directly onto the distribution block.

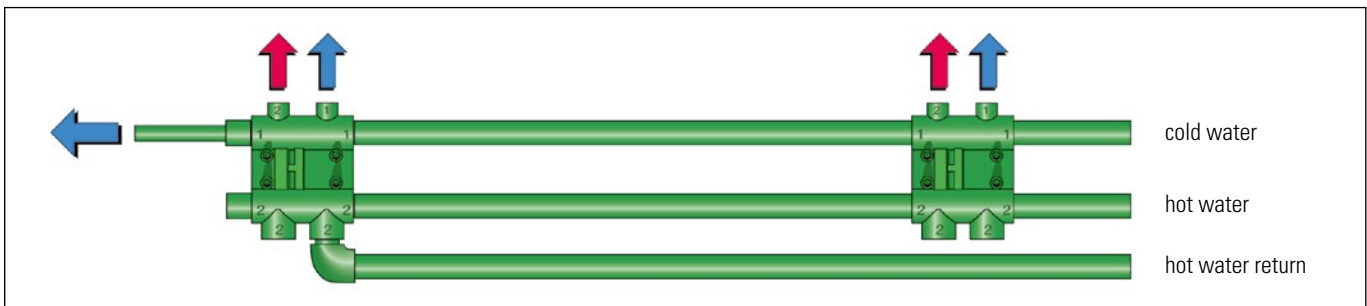

The supplied 25 mm end plug seals off a through-flow unit or, alternatively, the 16 mm end cap. By cutting the end of the plug, it can be used as 25 mm to 16 mm reducer or as 16 mm socket.

By turning the aquatherm green pipe distribution block and drilling out the factory-sealed outlets, it is possible to create compact connection arrangements even in areas of restricted space.

This avoids the time-consuming operation of guiding under or over pipes and the associated sealing work.

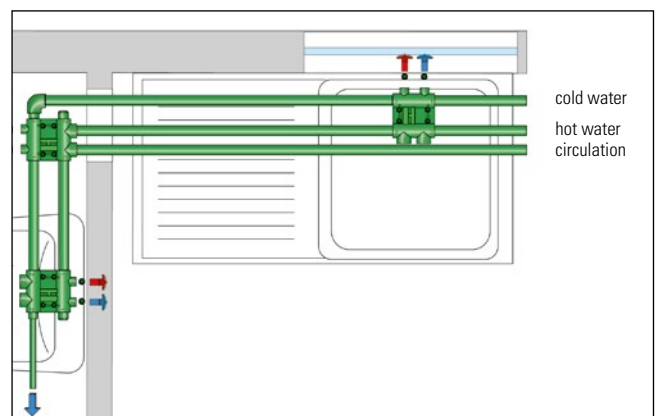

INSULATION FOR DISTRIBUTION BLOCK / AQUATHERM DISTRIBUTION BLOCK

Insulation for distribution block

It is also possible to install the compact distribution block by using a specially adapted insulation. In this case the green junction does not only avoid the crossing of pipes, but also the extra work involved in the expensive insulation of the double tee-branch.

The insulation for the aquatherm green pipe distribution block is made from high-quality PPO/PS rigid expanded polyurethane. Thus, a fast, unproblematic and safe insulation acc. to the current Decree for the Installation of Heating Systems is provided.

Thermal conductivity: WLG 040

Length: 184 mm

Width: 119 mm

Height: 70 mm

The accessories (1 plug, 2 fastening plugs) are integrated in the supply unit aquatherm green pipe distribution block.

aquatherm green pipe distribution block

If the radiator connection is not in the immediate vicinity of the pipe connection of the distribution block, this supply can be arranged with a 16 mm pipe by welding-in of two reducers 20/16 mm (Art. no. 11109).

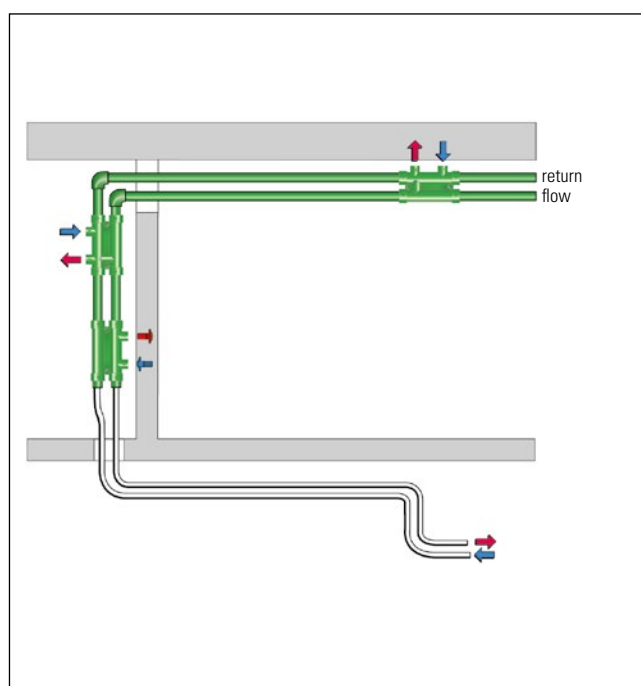

distribution block

**AQUATHERM DISTRIBUTION BLOCK:
EXAMPLE OF APPLICATIONS – HEATING**



The flow and return connections of heating pipes to the aquatherm distribution block are with aquatherm PP-R-pipes of an external diameter of 20 mm. Used in conjunction with the aquatherm connecting bend (Art. no. 85120) and the aquatherm radiator valves (Art. no. 79606 or 79608), the outgoing 16 mm pipe connections are ideal for radiator connections.

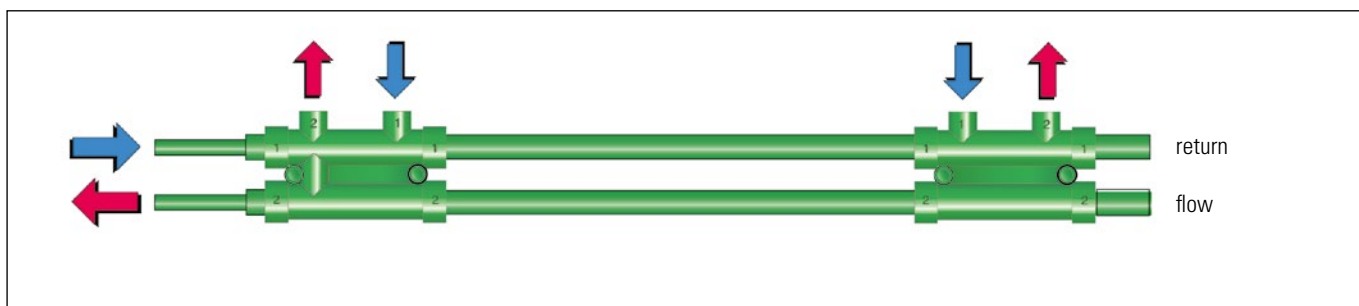

It is of no importance, where the heating flow or return is connected to the aquatherm distribution block. A simply turning of the distribution block adapts it to the appropriate specification.

CHEMICAL RESISTANCE

Due to their special material properties aquatherm green pipe resp. aquatherm blue pipe and fittings are generally chemical resistant. However, aquatherm green pipe transition elements with thread inserts made of brass are not suitable for all media.

For industrial application of aquatherm green pipe and aquatherm blue pipe we recommend to use aquatherm green pipe flanges and/or coupling screws.

Note: On request, you will receive threaded inserts for aquatherm green pipe connecting pieces also in stainless steel.
Prices on request.

INQUIRY FOR THE CHEMICAL RESISTANCE OF THE AQUATHERM GREEN PIPE AND AQUATHERM BLUE PIPE SYSTEM:

aquatherm GmbH

Technical department
Biggen 5 · D-57439 Attendorn
Phone: +49 (0)2722 950-0 · Fax: +49 (0)2722 950-100
E-mail: info@aquatherm.de · www.aquatherm.de

Installer:

Company

Contact

Street

PC/City

Phone

Fax

E-mail

Building project:

Address:

Street

PC/City

Place, Date/Signature

Field of application:

Flow medium

Operating temperature

°C/°F

Working pressure

bar/psi

Service life

h/d

Concentration

%

Ambient medium:

Ambient temperature

°C/°F

Ambient pressure

bar/psi

	Data sheets	enclosed	not enclosed
Fluid transported	<input type="checkbox"/>	<input type="checkbox"/>	<input type="checkbox"/>
Ambient medium	<input type="checkbox"/>	<input type="checkbox"/>	<input type="checkbox"/>

PLANNING

**DIN 1988 T3 / MAXIMUM FLOW RATE /
PRINCIPLES OF CALCULATION / CALCULATION GUIDE / SOFTWARE**

DIN EN 806 PART 3 AND DIN 1988 PART 300

DIN EN 806 part 3 and DIN 1988 part 300 (Technical Rules for Potable Water Installations) specifies the calculation principles for the determining of the pipe diameter.

The determining of the pipe diameter is based on the calculation of the pressure loss in pipes.

Beside the diameter the pressure loss depends on the length of the pipe, the pipe material and on the flow rate, dependent on the quantity and size of the water points to which the pipe is connected.

The basis for determining the maximum flow rate should be calculated on the desired flow rate of each water point. The simultaneous use resp. the peak pressure of flow of an installation part has to be determined by taking the calculation values from DIN 1988 T 3 as a basis.

Maximum flow rate

A further criterion for the selection of the pipe diameter is the maximum permissible flow rate. Because of sonic reasons and for the limitation of water hammer, the calculated flow rate may not exceed the values of the table below.

DIN EN 806-part 3

Collective supply pipes, riser pipes, storey pipes max. 2,0 m/s;
Individual supply pipes max. 4,0 m/s

NOTE: National regulations may require lower flow rates to avoid water hammers and noises.

DIN1988 part 300 table 5 – Maximum calculated flow rate in case of the related peak flow

Section of the installation	max. calculated flow rate at run (m/s)	
	< 15 min.	≥ 15 min.
Connecting pipes (Building connection)	2	2
Supply pipelines: Sections with resistance coefficients $\zeta < 2,5$ for individual resistances ^a	5	2
Sections with resistance coefficients $\zeta \geq 2,5$ for individual resistances ^b	2.5	2

^a i. e. piston valves acc. to DIN 3500. ball cock. inclined valves acc. to DIN 3502 (from DN 20)

^b i. e. screw-down stop globe valves acc. to DIN 3512

Principles of calculation

To determine the pipe diameter in potable water networks of buildings numerous principles of calculation are necessary. The revised version of DIN 1988 provides a simplified and differentiated method of calculation.

The simplified method is suitable for clearly arranged pipes i. e. in residential buildings. The differentiated method includes all pipes and local resistances and offers the highest accuracy as well as the most accurate approximation of real operating conditions. The determining of the pipe diameter requires the following data:

- Minimum gauge pressure of supply or pressure in flow direction behind pressure reducing or boosting valve
- Head variations
- Pressure loss due to apparatus i. e. watermeter, filter, softening installations etc.
- Minimum flow pressure of the water point applied
- Pipe friction factor of the used pipe material
- Coefficients of loss for fittings and pipe connections

Calculation guide / Software

We provide data sets for the following calculation programmes:

- MagiCAD
- liNear

Further data set formats can also be downloaded from our homepage:

- RFA
- STP
- IPT
- DWG

For any questions, please contact our aquatherm information service:
+ 49 (0) 2722 950-0



MINIMUM FLOW PRESSURE

Calculated flows of common water points

Minimum flow pressure $p_{\min, Fl}$	Type of water point		Calculated flow on taking:		
			mixed water ¹⁾		only cold or heated potable water
			V_R cold	V_R warm	V_R
bar	Designation		l/s	l/s	l/s
	Taps				
0.5	without air inlet (airator) ²⁾	DN 15	-	-	0.30
0.5	without air inlet (airator) ²⁾	DN 20	-	-	0.50
0.5	without air inlet (airator) ²⁾	DN 25	-	-	1.00
1.0	with air inlet (airator)	DN 10	-	-	0.15
1.0	with air inlet (airator)	DN 15	-	-	0.15
1.0	Shower heads for purification showers	DN 15	0.10	0.10	0.20
1.2	Flush valves acc. to DIN 3265 Part 1	DN 15	-	-	0.70
1.2		DN 20	-	-	1.00
0.4		DN 25	-	-	1.00
1.0	Flush valves urinals	DN 15	-	-	0.30
1.0	Domestic dish washers	DN 15	-	-	0.15
1.0	Domestic washing machine	DN 15	-	-	0.25
	Mixing battery for:				
1.0	Shower-bathes	DN 15	0.15	0.15	-
1.0	Bath-tubs	DN 15	0.15	0.15	-
1.0	Kitchen sinks	DN 15	0.07	0.07	-
1.0	Washstands	DN 15	0.07	0.07	-
1.0	Bidets	DN 15	0.07	0.07	-
1.0	Mixing battery	DN 20	0.30	0.30	-
0.5	Flushing- box DIN 19542	DN 15	-	-	0.13
1.0	Electro boiler	DN 15	-	-	0.10 ³⁾

COMMENT:

All other water points and apparatus of the above type with larger armature passages or minimum pressures of flow have to be considered with determining the pipe diameter acc. to the manufacturer`s instructions.

- ¹⁾ The calculated flows of mixed water points are based on 15 °C for cold potable water and 60 °C for hot potable water.
- ²⁾ In case of taps without air inlet (airator) and with hose screw, the loss of pressure in the hose pipe (up to 10 m length) and in the connected apparatus (i.e. lawn sprinkler) is considered over the minimum pressure of flow. The minimum pressure of flow is increased by 1.0 bar to 1.5 bar.
- ³⁾ In case of fully opened flow control valve.

MINIMUM FLOW PRESSURE

Determination of the peak flow rate V_S from the total flow $\sum V_R$ for buildings

acc. to DIN 1988 Teil 3 $V_S = 0.682 \cdot (\sum V_R)^{0.45} - 0.14$ [l/s]

$\sum V_R$	V_S	$\sum V_R$	V_S	$\sum V_R$	V_S	$\sum V_R$	V_S	$\sum V_R$	V_S	$\sum V_R$	V_S	$\sum V_R$	V_S	$\sum V_R$	V_S
0,03	0,00	1,02	0,55	2,02	0,80	3,02	0,98	4,02	1,14	5,10	1,28	10,10	1,79	15,10	2,17
0,04	0,02	1,04	0,55	2,04	0,80	3,04	0,98	4,04	1,14	5,20	1,29	10,20	1,80	15,20	2,18
0,06	0,05	1,06	0,56	2,06	0,80	3,06	0,99	4,06	1,14	5,30	1,30	10,30	1,81	15,30	2,19
0,07	0,07	1,08	0,57	2,08	0,81	3,08	0,99	4,08	1,14	5,40	1,32	10,40	1,82	15,40	2,19
0,08	0,08	1,10	0,57	2,10	0,81	3,10	0,99	4,10	1,15	5,50	1,33	10,50	1,82	15,50	2,20
0,09	0,09	1,12	0,58	2,12	0,82	3,12	1,00	4,12	1,15	5,60	1,34	10,60	1,83	15,60	2,21
0,10	0,10	1,14	0,58	2,14	0,82	3,14	1,00	4,14	1,15	5,70	1,35	10,70	1,84	15,70	2,21
0,13	0,13	1,16	0,59	2,16	0,82	3,16	1,00	4,16	1,16	5,80	1,36	10,80	1,85	15,80	2,22
0,15	0,15	1,18	0,59	2,18	0,83	3,18	1,01	4,18	1,16	5,90	1,38	10,90	1,86	15,90	2,23
0,20	0,19	1,20	0,60	2,20	0,83	3,20	1,01	4,20	1,16	6,00	1,39	11,00	1,87	16,00	2,23
0,22	0,21	1,22	0,61	2,22	0,84	3,22	1,01	4,22	1,16	6,10	1,40	11,10	1,87	16,10	2,24
0,24	0,22	1,24	0,61	2,24	0,84	3,24	1,02	4,24	1,17	6,20	1,41	11,20	1,88	16,20	2,25
0,26	0,23	1,26	0,62	2,26	0,84	3,26	1,02	4,26	1,17	6,30	1,42	11,30	1,89	16,30	2,25
0,28	0,24	1,28	0,62	2,28	0,85	3,28	1,02	4,28	1,17	6,40	1,43	11,40	1,90	16,40	2,26
0,30	0,26	1,30	0,63	2,30	0,85	3,30	1,03	4,30	1,17	6,50	1,44	11,50	1,91	16,50	2,27
0,32	0,27	1,32	0,63	2,32	0,86	3,32	1,03	4,32	1,18	6,60	1,45	11,60	1,91	16,60	2,27
0,34	0,28	1,34	0,64	2,34	0,86	3,34	1,03	4,34	1,18	6,70	1,47	11,70	1,92	16,70	2,28
0,36	0,29	1,36	0,64	2,36	0,86	3,36	1,04	4,36	1,18	6,80	1,48	11,80	1,93	16,80	2,29
0,38	0,30	1,38	0,65	2,38	0,87	3,38	1,04	4,38	1,19	6,90	1,49	11,90	1,94	16,90	2,29
0,40	0,31	1,40	0,65	2,40	0,87	3,40	1,04	4,40	1,19	7,00	1,50	12,00	1,95	17,00	2,30
0,42	0,32	1,42	0,66	2,42	0,88	3,42	1,05	4,42	1,19	7,10	1,51	12,10	1,95	17,10	2,31
0,44	0,33	1,44	0,66	2,44	0,88	3,44	1,05	4,44	1,19	7,20	1,52	12,20	1,96	17,20	2,31
0,46	0,34	1,46	0,67	2,46	0,88	3,46	1,05	4,46	1,20	7,30	1,53	12,30	1,97	17,30	2,32
0,48	0,35	1,48	0,67	2,48	0,89	3,48	1,06	4,48	1,20	7,40	1,54	12,40	1,98	17,40	2,33
0,50	0,36	1,50	0,68	2,50	0,89	3,50	1,06	4,50	1,20	7,50	1,55	12,50	1,99	17,50	2,33
0,52	0,37	1,52	0,68	2,52	0,89	3,52	1,06	4,52	1,20	7,60	1,56	12,60	1,99	17,60	2,34
0,54	0,38	1,54	0,69	2,54	0,90	3,54	1,06	4,54	1,21	7,70	1,57	12,70	2,00	17,70	2,35
0,56	0,39	1,56	0,69	2,56	0,90	3,56	1,07	4,56	1,21	7,80	1,58	12,80	2,01	17,80	2,35
0,58	0,39	1,58	0,70	2,58	0,90	3,58	1,07	4,58	1,21	7,90	1,59	12,90	2,02	17,90	2,36
0,60	0,40	1,60	0,70	2,60	0,91	3,60	1,07	4,60	1,22	8,00	1,60	13,00	2,02	18,00	2,36
0,62	0,41	1,62	0,71	2,62	0,91	3,62	1,08	4,62	1,22	8,10	1,61	13,10	2,03	18,10	2,37
0,64	0,42	1,64	0,71	2,64	0,92	3,64	1,08	4,64	1,22	8,20	1,62	13,20	2,04	18,20	2,38
0,66	0,43	1,66	0,72	2,66	0,92	3,66	1,08	4,66	1,22	8,30	1,63	13,30	2,05	18,30	2,38
0,68	0,43	1,68	0,72	2,68	0,92	3,68	1,09	4,68	1,23	8,40	1,64	13,40	2,05	18,40	2,39
0,70	0,44	1,70	0,73	2,70	0,93	3,70	1,09	4,70	1,23	8,50	1,65	13,50	2,06	18,50	2,40
0,72	0,45	1,72	0,73	2,72	0,93	3,72	1,09	4,72	1,23	8,60	1,66	13,60	2,07	18,60	2,40
0,74	0,46	1,74	0,74	2,74	0,93	3,74	1,09	4,74	1,23	8,70	1,67	13,70	2,07	18,70	2,41
0,76	0,46	1,76	0,74	2,76	0,94	3,76	1,10	4,76	1,24	8,80	1,67	13,80	2,08	18,80	2,41
0,78	0,47	1,78	0,74	2,78	0,94	3,78	1,10	4,78	1,24	8,90	1,68	13,90	2,09	18,90	2,42
0,80	0,48	1,80	0,75	2,80	0,94	3,80	1,10	4,80	1,24	9,00	1,69	14,00	2,10	19,00	2,43
0,82	0,48	1,82	0,75	2,82	0,95	3,82	1,11	4,82	1,24	9,10	1,70	14,10	2,10	19,10	2,43
0,84	0,49	1,84	0,76	2,84	0,95	3,84	1,11	4,84	1,25	9,20	1,71	14,20	2,11	19,20	2,44
0,86	0,50	1,86	0,76	2,86	0,95	3,86	1,11	4,86	1,25	9,30	1,72	14,30	2,21	19,30	2,44
0,88	0,50	1,88	0,77	2,88	0,96	3,88	1,12	4,88	1,25	9,40	1,73	14,40	2,12	19,40	2,45
0,90	0,51	1,90	0,77	2,90	0,96	3,90	1,12	4,90	1,25	9,50	1,74	14,50	2,13	19,50	2,46
0,92	0,52	1,92	0,77	2,92	0,96	3,92	1,12	4,92	1,26	9,60	1,75	14,60	2,14	19,60	2,46
0,94	0,52	1,94	0,78	2,94	0,97	3,94	1,12	4,94	1,26	9,70	1,76	14,70	2,15	19,70	2,47
0,96	0,53	1,96	0,78	2,96	0,97	3,96	1,13	4,96	1,26	9,80	1,76	14,80	2,15	19,80	2,47
0,98	0,54	1,98	0,79	2,98	0,97	3,98	1,13	4,98	1,26	9,90	1,77	14,90	2,16	19,90	2,48
1,00	0,54	2,00	0,79	3,00	0,98	4,00	1,13	5,00	1,27	10,00	1,78	15,00	2,17	20,00	2,49

This table is valid, if the calculated flow V_R of the respective water points is less than 0.5 l/s.

MINIMUM FLOW PRESSURE











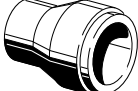
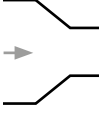

Determination of the peak flow rate V_s from the total flow ΣV_R for buildings

acc. to DIN 1988 Teil 3 $V_s = 1.7 \cdot (\Sigma V_R)^{0.21} - 0.7$ [l/s]

ΣV_R	V_s	ΣV_R	V_s	ΣV_R	V_s	ΣV_R	V_s	ΣV_R	V_s	ΣV_R	V_s	ΣV_R	V_s	ΣV_R	V_s
1,00	1,00	5,10	1,69	10,10	2,06	15,10	2,31	22,40	2,57	142,20	4,12	262,40	4,78	382,40	5,23
1,05	1,02	5,20	1,70	10,20	2,07	15,20	2,31	24,80	2,64	144,80	4,13	264,80	4,79	384,80	5,23
1,10	1,03	5,30	1,71	10,30	2,07	15,30	2,31	27,20	2,70	147,20	4,15	267,20	4,81	387,20	5,24
1,15	1,05	5,40	1,72	10,40	2,08	15,40	2,32	29,60	2,76	149,60	4,17	269,60	4,81	389,60	5,25
1,20	1,07	5,50	1,73	10,50	2,09	15,50	2,32	32,00	2,82	152,00	4,18	272,00	4,82	392,00	5,26
1,25	1,08	5,60	1,74	10,60	2,09	15,60	2,33	34,40	2,87	154,40	4,20	274,40	4,83	394,40	5,26
1,30	1,10	5,70	1,75	10,70	2,10	15,70	2,33	36,80	2,92	156,80	4,21	276,80	4,84	396,80	5,27
1,35	1,11	5,80	1,76	10,80	2,10	15,80	2,34	39,20	2,97	159,20	4,23	279,20	4,85	399,20	5,28
1,40	1,12	5,90	1,77	10,90	2,11	15,90	2,34	41,60	3,02	161,60	4,25	281,60	4,86	401,60	5,29
1,45	1,14	6,00	1,78	11,0	2,11	16,00	2,34	44,00	3,06	164,00	4,26	284,00	4,87	404,00	5,29
1,50	1,15	6,10	1,79	11,10	2,12	16,10	2,35	46,40	3,11	166,40	4,28	286,40	4,88	406,40	5,30
1,55	1,16	6,20	1,79	11,20	2,12	16,20	2,35	48,80	3,15	168,80	4,29	288,80	4,89	408,80	5,31
1,60	1,18	6,30	1,80	11,30	2,13	16,30	2,35	51,20	3,19	171,20	4,31	291,20	4,90	411,20	5,32
1,65	1,19	6,40	1,81	11,40	2,13	16,40	2,36	53,60	3,22	173,60	4,32	293,60	4,91	413,60	5,32
1,70	1,20	6,50	1,82	11,50	2,14	16,50	2,36	56,00	3,26	176,00	4,34	296,00	4,92	416,00	5,33
1,75	1,21	6,60	1,83	11,60	2,14	16,60	2,37	58,40	3,29	178,40	4,35	298,40	4,93	418,40	5,34
1,80	1,22	6,70	1,83	11,70	2,15	16,70	2,37	60,80	3,33	180,80	4,36	300,80	4,93	420,80	5,35
1,85	1,23	6,80	1,84	11,80	2,15	16,80	2,37	63,20	3,36	183,20	4,38	303,20	4,94	423,20	5,35
1,90	1,25	6,90	1,85	11,90	2,16	16,90	2,38	65,60	3,39	185,60	4,36	305,60	4,95	425,60	5,36
2,00	1,27	7,00	1,86	12,00	2,16	17,00	2,38	68,00	3,42	188,00	4,41	308,00	4,96	428,00	5,37
2,10	1,29	7,10	1,87	12,10	2,17	17,10	2,39	70,40	3,45	190,40	4,42	310,40	4,97	430,40	5,38
2,20	1,31	7,20	1,87	12,20	2,17	17,20	2,39	72,80	3,48	192,80	4,43	312,80	4,98	432,80	5,38
2,30	1,32	7,30	1,88	12,30	2,18	17,30	2,39	75,20	3,51	195,20	4,45	315,20	4,99	435,20	5,39
2,40	1,34	7,40	1,89	12,40	2,18	17,40	2,40	77,60	3,54	197,60	4,46	317,60	5,00	437,60	5,40
2,50	1,36	7,50	1,90	12,50	2,19	17,50	2,40	80,00	3,57	200,00	4,47	320,00	5,01	440,00	5,40
2,60	1,38	7,60	1,90	12,60	2,19	17,60	2,40	82,40	3,59	202,40	4,49	322,40	5,02	442,40	5,41
2,70	1,39	7,70	1,91	12,70	2,20	17,70	2,41	84,80	3,62	204,80	4,50	324,80	5,03	444,80	5,42
2,80	1,41	7,80	1,92	12,80	2,20	17,80	2,41	87,20	3,64	207,20	4,51	327,20	5,04	447,20	5,42
2,90	1,43	7,90	1,92	12,90	2,21	17,90	2,42	89,60	3,67	209,60	4,52	329,60	5,04	452,00	5,43
3,00	1,44	8,00	1,93	13,00	2,21	18,00	2,42	92,00	3,69	212,00	4,54	332,00	5,05	454,40	5,44
3,10	1,46	8,10	1,94	13,10	2,22	18,10	2,42	94,40	3,72	214,40	4,55	334,40	5,06	456,80	5,44
3,20	1,47	8,20	1,94	13,20	2,22	18,20	2,43	96,80	3,74	216,80	4,56	336,80	5,07	459,20	5,45
3,30	1,48	8,30	1,95	13,30	2,23	18,30	2,43	99,20	3,76	219,20	4,57	339,20	5,08	461,60	5,46
3,40	1,50	8,40	1,96	13,40	2,23	18,40	2,43	101,60	3,79	221,60	4,58	341,60	5,09	464,00	5,47
3,50	1,51	8,50	1,96	13,50	2,24	18,50	2,44	104,00	3,81	224,00	4,60	344,00	5,10	466,40	5,47
3,60	1,52	8,60	1,97	13,60	2,24	18,60	2,44	106,40	3,83	226,40	4,61	346,40	5,10	468,80	5,48
3,70	1,54	8,70	1,98	13,70	2,25	18,70	2,44	108,80	3,85	228,80	4,62	348,80	5,11	471,20	5,49
3,80	1,55	8,80	1,98	13,80	2,25	18,80	2,45	111,20	3,87	231,20	4,63	351,20	5,12	473,60	5,49
3,90	1,56	8,90	1,99	13,90	2,25	18,90	2,45	113,60	3,89	233,60	4,64	353,60	5,13	476,00	5,50
4,00	1,57	9,00	2,00	14,00	2,26	19,00	2,45	116,00	3,91	236,00	4,66	356,00	5,14	478,40	5,51
4,10	1,59	9,10	2,00	14,10	2,26	19,10	2,46	118,40	3,93	238,40	4,67	358,40	5,15	480,80	5,51
4,20	1,60	9,20	2,01	14,20	2,27	19,20	2,46	120,80	3,95	240,80	4,68	360,80	5,15	483,20	5,52
4,30	1,61	9,30	2,02	14,30	2,27	19,30	2,47	123,20	3,97	243,20	4,69	363,20	5,16	485,60	5,52
4,40	1,62	9,40	2,02	14,40	2,28	19,40	2,47	125,60	3,99	245,60	4,70	365,00	5,17	488,00	5,53
4,50	1,63	9,50	2,03	14,50	2,28	19,50	2,47	128,00	4,01	248,00	4,71	368,00	5,18	490,40	5,54
4,60	1,64	9,60	2,03	14,60	2,29	19,60	2,48	130,40	4,03	250,40	4,72	370,40	5,19	492,40	5,54
4,70	1,65	9,70	2,04	14,70	2,29	19,70	2,48	132,80	4,05	252,80	4,763	372,80	5,19	492,80	5,55
4,80	1,66	9,80	2,05	14,80	2,29	19,80	2,48	135,20	4,06	255,20	4,74	375,20	5,20	495,20	5,56
4,90	1,67	9,90	2,05	14,90	2,30	19,90	2,49	137,60	4,08	257,60	4,75	377,60	5,21	497,60	5,56
5,00	1,68	10,00	2,06	15,00	2,30	20,00	2,49	140,00	4,10	260,00	4,77	380,00	5,22	500,00	5,57





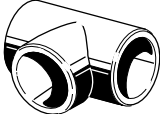
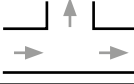
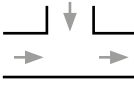
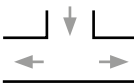
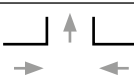
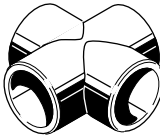
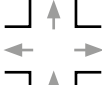
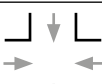

This table is valid, if the calculated flow V_R of the respective water points is less than 0.5 l/s.

Coefficient of loss ζ aquatherm green pipe fittings

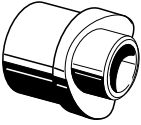
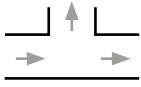
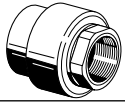
Fitting	Picture	Symbol	Comment	ζ -Value
Socket				0.25
Reducer			Reduction...	
			...by 1 dimension	0.40
			...by 2 dimension	0.50
			...by 3 dimension	0.60
			...by 4 dimension	0.70
			...by 5 dimension	0.80
...by 6 dimension	0.90			
Elbow 90°				1.20
Segment elbow 90° (200–630 mm)				0,80
Elbow 90° male/female				1.20
Elbow 45°				0.50
Elbow 45° male/female				0.50
			Separation of flow	1.20
			Conjunction of flow	0.80
			Counter current in case of separation of flow	1.80
			Counter current in case of conjunction of flow	3.00
Reducing tee	The z-value results from the addition of tee and reducer			
Cross			Separation of flow	2.10
			Conjunction of flow	3.70

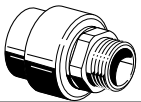

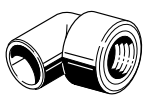
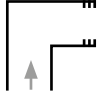
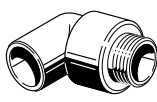
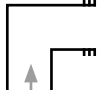
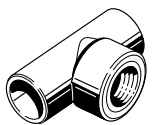
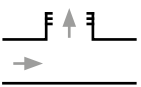
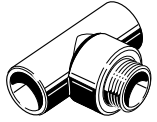



(→ = flow direction)

Coefficient of loss ζ aquatherm green pipe fittings

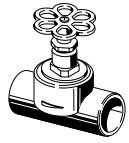
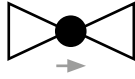
Fitting	Picture	Symbol	Comment	ζ -Value
			Separation of flow	0.5
Reducing tee	The z-value results from the addition of the weld in saddle and tee			
Transition piece with female thread				0.50
Transition piece with male thread				0.70
Elbow with female thread				1.40
Elbow with male thread				1.60
Transition tee with female thread			Separation of flow	
			- 16 x 1/2" x 16 - 20 x 3/4" x 20	1.40
			- 20 x 1/2" x 20 - 25 x 3/4" x 25 - 32 x 1" x 32	1.60
			- 25 x 1/2" x 25 - 32 x 3/4" x 32	1.80
Threaded branch tee with male thread			Separation of flow - 20 x 1/2" x 20	1.80

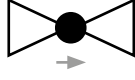
(→ = flow direction)

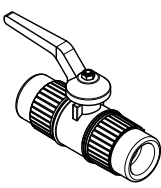
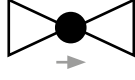
Coefficient of loss ζ aquatherm green pipe fittings

Fitting	Picture	Symbol	Comment	ζ -Value
Screw-down stop globe valve			- 20 mm	10
			- 25 mm	8,5
			- 32 mm	7
			- 40 mm	6
Inclined valve			- 20 mm	3,5
			- 25 mm	2,5
			- 32 mm	2
			- 40 mm	2
Non-return valve			- 20 mm	7,7
			- 25 mm	6
			- 32 mm	5
			- 40 mm	5
Ball valve			- 20 mm	1
			- 25 mm	0,5
			- 32 mm	0,5
			- 40 mm	0,3
			- 50 mm	0,3
			- 63 mm	0,3
Draining branch				

Source: DIN 1988 Part 3

(→ = flow direction)

$$Z = \frac{\zeta v^2 \delta}{2}$$

Z = Pressure lost in [Pa]

v = Flow rate [m/s]

ζ = Coefficient of loss of fitting

δ = Density of medium [kg/m³]

(K_v = Cold Water Volume Rate circulatory [m³/h] of water [5–30 °C] at a pressure difference of 1 bar)

Note: For the determination of pressure loss in (mbar) the result has to be divided by the factor 100 (100Pa = 1 mbar).

1bar = 10⁵ Pa = 14,5 psi = 10 N/cm²)

Notice on planning & design of compressed air applications

When planning and designing pipe systems for compressed air applications, the following working pressures are to be observed.

aquatherm blue pipe SDR 11	aquatherm green pipe SDR 9
10 bar	15 bar

This chart is valid for temperatures from 10 °C to 40 °C. For temperatures and conditions other than those noted in the chart, please contact our technical service department.

Warning: Failure of a compressed gas (air or inert gas) system can be extremely violent and dangerous. In a compressed gaseous media piping system, energy is applied to compress the gaseous media in addition to pressurizing the system. If failure occurs, both energies can be suddenly released and can be extremely violent compared to failure during leak testing or system operation with an incompressible liquid testing media.

aquatherm recommends that thermoplastics piping intended for the transport of compressed air or other compressed gases should be installed by burial, encasement in shatter-resistant material or other appropriate means, to prevent or minimize the possibility of mechanical damage. The piping must also be protected from other sources of degradation such as ultraviolet light (UV) exposure, chemical effects, temperature and oxidation.

Always make sure to eliminate risks for persons near compressed air systems, also observing the applicable national and international regulations of installation, accident prevention and safety for the installation of pipe systems, as well as the applicable laws, standards, guidelines and technical rules.

Coefficient of loss ζ aquatherm green pipe distribution block

Picture	Comment	Picture	Comment	ζ -Value
Potable water installation Cold water Hot water 	Reduced 25 mm passage in case of separation of flow	Heating installation Return Flow 	Reduced 20 mm passage in case of separation of flow	1.00
	25 mm passage in case of separation of flow		20 mm passage in case of separation of flow	0.25
Potable water installation Cold water Hot water 	20 mm passage in case of separation of flow	Heating installation Return Flow 	16 mm branch in case of separation of flow	0.80
	20 mm branch in case of conjunction of flow		16 mm branch in case of conjunction of flow	1.60
	Reduced 20 mm passage in case of separation of flow		16 mm branch in case of separation of flow	2.20
Potable water installation Cold water Hot water 		Heating installation Hot water Cold water Hot water return 	25 mm branch in case of separation of flow	1.20
			16 mm branch in case of conjunction of flow	0.80

TABLE OF CONTENTS

- **aquatherm green pipe** pipes
- **aquatherm blue pipe** pipes
- **aquatherm lilac pipe** pipes
- Fastening material
- Fittings
- Weld-in saddle
- Weld-on saddle
- Flange adapter
- Threaded connections and accessories
- Transition pieces
- Screwed connections and counter parts
- Distributors
- Valves and accessories
- Cutting tools, welding devices
- Welding machines and welding jig
- Butt welding machines & electrofusion device
- Peeling tools
- Saddle welding tools
- Drills & saddle peeling tool
- Hot tapping tool and accessoires

aquatherm green pipe

The innovative all-rounder, which revolutionized the plastic pipe sector, made a name for itself within a very short time that stands for highest quality and outstanding ecological properties. The aquatherm system has proven its excellent technical suitability in more than 30 years of application worldwide, and among experts has long been one of the most extensive and at the same time best plastic pipe systems.

The system includes the different types of pipes SDR 6, SDR 7.4, SDR 9 and SDR 11. These are supplemented by the especially reinforced fiber composite pipe. More than 450 joining and connection elements as well as valves and ball valves complete the system. The products are available from 16 mm to 450 mm external diameter.

Pipe system made of polypropylene for potable water supply

article no.	brand name	Standard Dimension Ratio	structure of pipe	special feature of pipe	material
10208 ... 10248	aquatherm green pipe	SDR 11	S		PP-R
10806 ... 10818	aquatherm green pipe	SDR 7.4	S		PP-R
10006 ... 10024	aquatherm green pipe	SDR 6	S		PP-R
70708 ... 70738	aquatherm green pipe	SDR 7.4	MF		PP-R
70758 ... 70788	aquatherm green pipe	SDR 7.4	MF	UV	PP-R
1370711 ... 1370738	aquatherm green pipe	SDR 9	MF	TI	PP-R
370712 ... 370744	aquatherm green pipe	SDR 9	MF	RP	PP-RP
370762 ... 370794	aquatherm green pipe	SDR 9	MF	RP UV	PP-RP

MANIFOLD CONSTRUCTION – CUSTOM MADE

We design and construct your manifolds in our company according to your specifications and dispatch them pre-finished to any place of the world.

You only have to send us the drawings and/or sketches with specifications. We return the offer including material list and drawing. A qualified team of experienced technicians likes to assist you.

For detailed information referring "manifold construction" please contact our technical hotline: +49 (0) 2722 950-200!

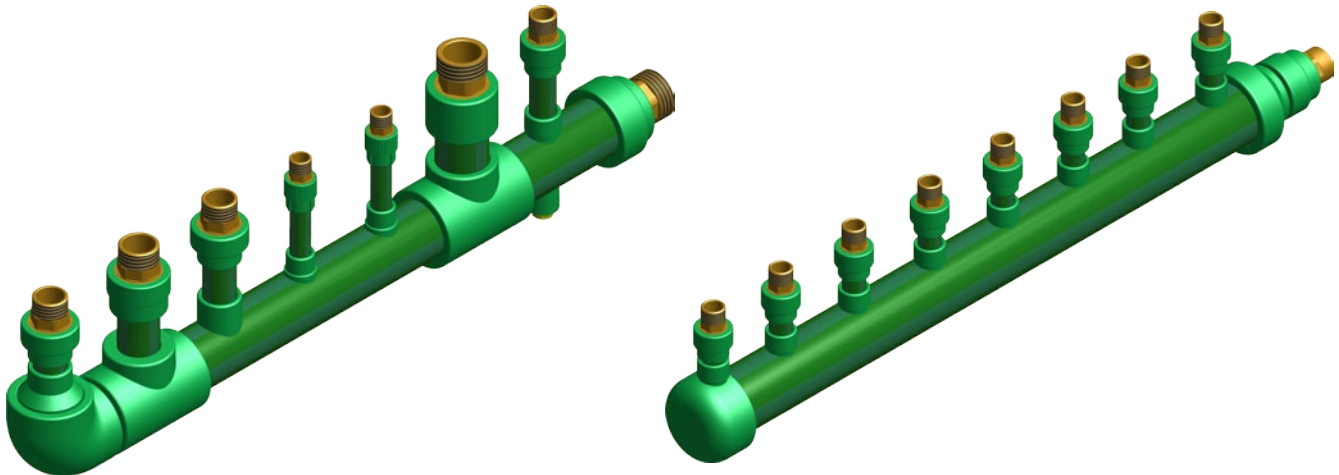

aquatherm green pipe SDR 9 MF RP

Structure of pipe:	MF = multilayer, with fibre reinforced
Special feature of pipe:	RP (raised pressure)
Material:	fusiolen PP-R
Pipe series:	SDR 9/S 4
Standards:	SKZ HR 3.28, ASTM F 2389, ISO 21003 SKZ A632/A644
Colour:	green with 4 dark green stripes
Form supplied:	ø 32–125 mm straight lengths 4 m ø 160–355 mm straight lengths 5.8 m
Packing Unit:	PU in meter
Application:	

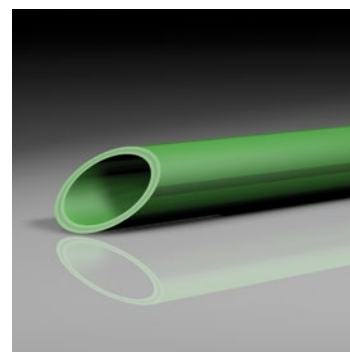
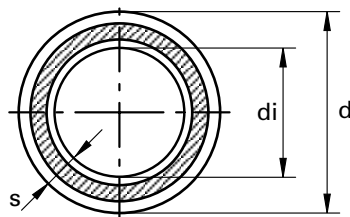

Mechanically stabilized through a fibre mix integrated in the middle layer of the fusiolen® PP-R.

SDR	Art. no.	Dimension d [mm]	Wall thickness s [mm]	Internal diameter di [mm]	Water content [l/m]	Weight [kg]	DN	PU [m]	Price € m/pc	
9	<i>Socket welding</i>									
		370712	32	3,6	24,8	0,483	0,328	25	40	
		370714	40	4,5	31,0	0,754	0,511	32	40	
		370716	50	5,6	38,8	1,182	0,791	40	20	
		370718	63	7,1	48,8	1,869	1,261	50	20	
		370720	75	8,4	58,2	2,659	1,771	-	20	
		370722	90	10,1	69,8	3,825	2,553	65	12	
		370724	110	12,3	85,4	5,725	3,789	80	8	
		370726	125	14,0	97,0	7,386	4,886	100	4	
		<i>Butt welding</i>								
		370730	160	17,9	124,2	12,109	7,987	125	5.8	
		370734	200	22,4	155,2	18,908	12,488	150	5.8	
		370738	250	27,9	194,2	29,605	19,422	200	5.8	
		370742	315	35,2	244,6	46,966	30,876	250	5.8	
	370744	355	39,7	275,6	59,625	39,202	-	5.8		

aquatherm green pipe SDR 7.4 MF

Structure of pipe:	MF = multilayer, with fibre reinforced
Material:	fusiolen PP-R
Pipe series:	SDR 7.4/S 3.2
Standards:	SKZ HR 3.28, ASTM F 2389, CSA B 137.11, ISO 21003 SKZ A314/616
Colour:	green with 4 dark green stripes
Packing Unit:	straight legths 4 m
Packing Unit:	PU in meter
Application:	

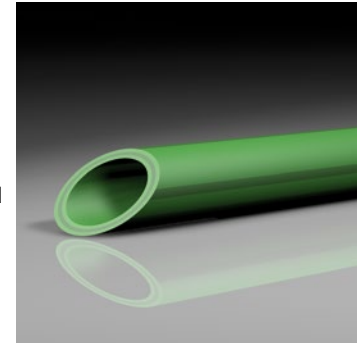
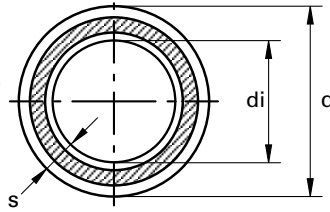

Mechanically stabilized through a fibre mix integrated in the middle layer of the fusiolen® PP-R.

SDR	Art. no.	Dimension d [mm]	Wall thickness s [mm]	Internal diameter di [mm]	Water content [l/m]	Weight [kg]	DN	PU [m]	Price € m/pc
7.4	<i>Socket welding</i>								
	70708	20	2,8	14,4	0,163	0,157	15	100	
	70710	25	3,5	18,0	0,254	0,244	20	100	
	70712	32	4,4	23,2	0,423	0,391	25	40	
	70714	40	5,5	29,0	0,660	0,608	32	40	
	70716	50	6,9	36,2	1,029	0,948	40	20	
	70718	63	8,6	45,8	1,647	1,490	50	20	
	70720	75	10,3	54,4	2,323	2,120	-	20	
	70722	90	12,3	65,4	3,358	3,037	65	12	
	70724	110	15,1	79,8	4,999	4,546	80	8	
	70726	125	17,1	90,8	6,472	5,850	-	4	
	<i>Butt welding</i>								
	70730	160	21,9	116,2	10,599	9,559	125	5.8	
	70734	200	27,4	145,2	16,558	14,944	150	5.8	
70738	250	34,2	181,6	25,901	23,312	175	5.8		
315–355		<i>Dimensions 315 and 355 mm see aquatherm green pipe SDR 9 MF RP on page 10</i>							

aquatherm green pipe SDR 9 MF RP UV

- Structure of pipe:** MF = multilayer, with fibre reinforced
- Special feature of pipe:** RP (raised pressure), UV resistant
- Material:** fusiolen PP-RP
- Pipe series:** SDR 9/S 4
- Standards:** SKZ HR 3.28, ASTM F 2389, ISO 21003, SKZ A632/A644
- Colour:** inner layer: green with 4 dark green stripes
outer layer: black
- Form supplied:** ø 32–125 mm straight lengths 4 m
ø 160–355 mm straight lengths 5.8 m
- Packing Unit:** PU in meter
- Application:**

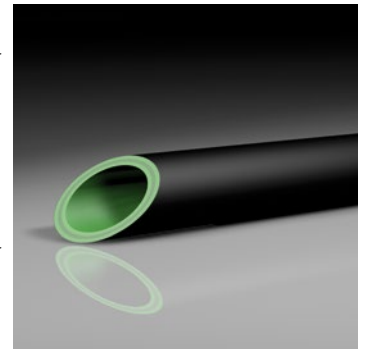
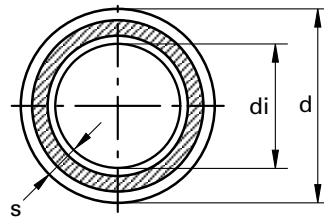

Resistant against UV-rays. Mechanically stabilized through a faser mix integrated in the middle layer of the fusiolen® PP-R.

SDR	Art. no.	Dimension d [mm]	Wall thickness s [mm]	Internal diameter di [mm]	Water content [l/m]	Weight [kg]	DN	PU [m]	Price € m/pc	
9	<i>Socket welding</i>									
		370762	32	3,6	24,8	0,483	0,422	25	40	
		370764	40	4,5	31,0	0,754	0,630	32	40	
		370766	50	5,6	38,8	1,182	0,944	40	20	
		370768	63	7,1	48,8	1,869	1,457	50	20	
		370770	75	8,4	58,2	2,659	1,998	-	20	
		370772	90	10,1	69,8	3,825	2,894	65	12	
		370774	110	12,3	85,4	5,725	4,397	80	8	
		370776	125	14,0	97,0	7,386	5,530	100	4	
		<i>Butt welding</i>								
		370780	160	17,9	124,2	12,109	8,287	125	5.8	
		370784	200	22,4	155,2	18,908	12,818	150	5.8	
		370788	250	27,9	194,2	29,605	19,741	200	5.8	
		370792	315	35,2	244,6	46,966	31,135	250	5.8	
		370794	355	39,7	275,6	59,625	39,415	-	5.8	

aquatherm green pipe SDR 7.4 MF UV

Structure of pipe:	MF = multilayer, with fibre reinforced
Special feature of pipe:	UV resistant
Material:	fusiolen PP-R
Pipe series:	SDR 7.4/S 3.2
Standards:	SKZ HR 3.28, ASTM F 2389, CSA B 137.11, ISO 21003 SKZ A314/616
Colour:	outer layer: black inner layer: green
Form supplied:	straight lengths 4 m ø 160–250 mm straight lengths 5.8 m
Packing Unit:	PU in meter
Application:	

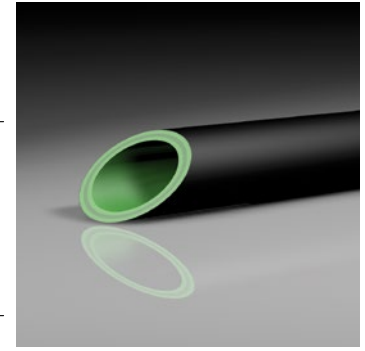
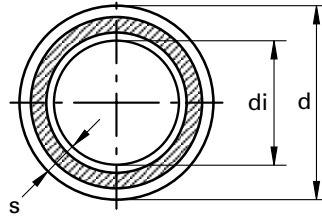

Resistant against UV-rays. Mechanically stabilized through a faser mix integrated in the middle layer of the fusiolen® PP-R.

SDR	Art. no.	Dimension d [mm]	Wall thickness s [mm]	Internal diameter di [mm]	Water content [l/m]	Weight [kg]	DN	PU [m]	Price € m/pc
7.4	<i>Socket welding</i>								
	70758	20	2,8	14,4	0,163	0,210	15	100	
	70760	25	3,5	18,0	0,254	0,314	20	100	
	70762	32	4,4	23,2	0,423	0,485	25	40	
	70764	40	5,5	29,0	0,660	0,728	32	40	
	70766	50	6,9	36,2	1,029	1,101	40	20	
	70768	63	8,6	45,8	1,647	1,686	50	20	
	70770	75	10,3	54,4	2,323	2,347	-	20	
	70772	90	12,3	65,4	3,358	3,378	65	12	
	70774	110	15,1	79,8	4,999	5,054	80	8	
	70776	125	17,1	90,8	6,472	6,494	-	4	
	<i>Butt welding</i>								
	70780	160	21,9	116,2	10,599	9,859	100	5.8	
70784	200	27,4	145,2	16,550	15,273	150	5.8		
70788	250	34,2	181,6	25,888	23,630	175	5.8		
	315–355	<i>Dimensions 315 and 355 mm see aquatherm green pipe SDR 9 MF RP UV on page 12</i>							

aquatherm green pipe SDR 6 / 7.4 S

- Structure of pipe:** s (single)
Material: fusiolen PP-R
Pipe series: SDR 6/S 2.5 & SDR 7.4/S 3.2
Standards: DIN 8077, DIN 8078, DIN EN ISO 15874, ASTM F 2389, CSA B 137.11
Colour: green
Form supplied: 4 m straight lengths, also* in coils
Packing Unit: PU in meter
Application:

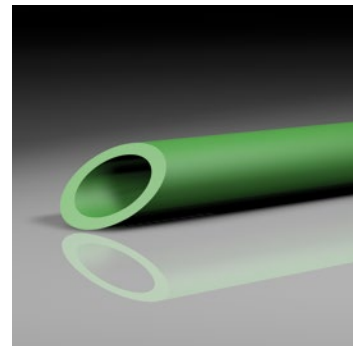
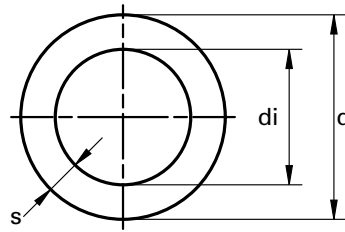

SDR	Art. no.	Dimension d [mm]	Wall thickness s [mm]	Internal diameter di [mm]	Water content [l/m]	Weight [kg]	DN	PU [m]	Price € m/pc
6	10006	16	2,7	10,6	0,088	0,111	10	100	
	10008	20	3,4	13,2	0,137	0,174	12	100	
	10010	25	4,2	16,6	0,216	0,268	15	100	
	10012	32	5,4	21,2	0,353	0,437	20	40	
	10014	40	6,7	26,6	0,555	0,675	25	40	
	10016	50	8,3	33,4	0,876	1,047	32	20	
	10018	63	10,5	42,0	1,385	1,662	40	20	
	10020	75	12,5	50,0	1,963	2,351	50	20	
	10022	90	15,0	60,0	2,826	3,379	60	12	
	10024	110	18,3	73,4	4,229	5,040	65	8	
	10106*	16	2,7	10,6	0,088	0,111	10	100	
	10108*	20	3,4	13,2	0,137	0,174	12	100	
	10110*	25	4,2	16,6	0,216	0,268	15	100	
	7.4	10806	16	2,2	11,6	0,106	0,096	12	100
10808		20	2,8	14,4	0,163	0,149	15	100	
10810		25	3,5	18,0	0,254	0,232	20	100	
10812		32	4,4	23,2	0,423	0,372	25	40	
10814		40	5,5	29,0	0,660	0,578	32	40	
10816		50	6,9	36,2	1,029	0,901	40	20	
10818		63	8,6	45,8	1,647	1,416	50	20	
10906*		16	2,2	11,6	0,106	0,096	12	100	
10908*		20	2,8	14,4	0,163	0,149	15	100	

aquatherm green pipe SDR 11 S / MF

- Structure of pipe:** 20–355 mm = s (single)
400&450 mm = MF (multilayer faser)
- Material:** fusiolen PP-R
- Pipe series:** SDR 11/S5
- Standards:** DIN 8077 / 78, DIN EN ISO 15874, ASTM F 2389, CSA B 137.11
- Colour:** green with 4 blue stripes
- Form supplied:** ø 20–125 mm 4 m straight lengths, also* in coils
ø 160–450 mm straight lengths 5,8 m
- Packing Unit:** PU in meter

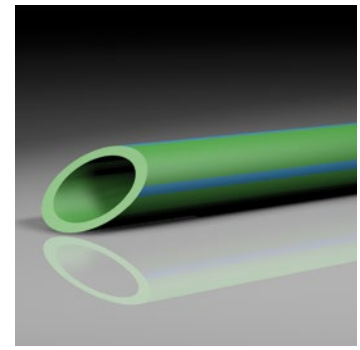
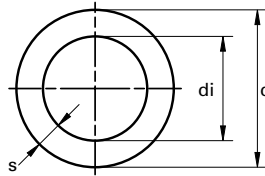

SDR	Art. no.	Dimension d [mm]	Wall thickness s [mm]	Internal diameter di [mm]	Water content [l/m]	Weight [kg]	DN	PU [m]	Price € m/pc
11	<i>Socket welding</i>								
	10208	20	1,9	16,2	0,206	0,108	15	100	
	10210	25	2,3	20,4	0,327	0,165	20	100	
	10212	32	2,9	26,2	0,539	0,261	25	40	
	10214	40	3,7	32,6	0,834	0,414	32	40	
	10216	50	4,6	40,8	1,307	0,641	40	20	
	10218	63	5,8	51,4	2,074	1,012	50	20	
	10220	75	6,8	61,4	2,959	1,411	65	20	
	10222	90	8,2	73,6	4,252	2,043	80	12	
	10224	110	10,0	90,0	6,359	3,026	-	8	
	10226	125	11,4	102,2	8,199	3,924	100	4	
	10308*	20	1,9	16,2	0,206	0,108	15	100	
	10310*	25	2,3	20,4	0,327	0,165	20	100	
	10312*	32	2,9	26,2	0,539	0,261	25	50	
	<i>Butt welding</i>								
	10230	160	14,6	130,8	13,430	6,415	125	5,8	
	10234	200	18,2	163,6	21,010	9,992	150	5,8	
	10238	250	22,7	204,6	32,861	15,548	200	5,8	
10242	315	28,6	257,8	52,172	24,664	250	5,8		
10244	355	32,2	290,6	66,325	31,300	300	5,8		
10246 ¹⁾	400	36,3	327,6	84,290	39,734	300	5,8		
10248 ¹⁾	450	40,9	368,2	106,477	50,292	400	5,8		

¹⁾ mechanically stabilized through a fibre mix integrated in the middle layer of the fusiolen® PP-R

aquatherm blue pipe

aquatherm blue pipe, our specialty for distributing cooling and heating in closed and open systems as well as in several industrial applications. It was developed in order to prevent corrosion in heating system pipes *sowie in Kühl- und Kälteanlagen* and quickly expanded its range of application, with many positive features for other fields of piping installation. It has gone on to find success around the world in hotels, stadiums, schools, offices, and industrial applications. In addition to the general advantages of the PP-R-pipesystem aquatherm blue pipe in comparison with the aquatherm green pipe system it offers higher volumetric current values due to smaller wall thickness.

Pipe system made of polypropylene

for chilled, hot fluid and various industrial applications

article no.	brand name	Standard Dimension Ratio	structure of pipe	special feature of pipe	material
2010208 . . . 2010212	aquatherm blue pipe	SDR 11	S		PP-R
2070112 . . . 2070712	aquatherm blue pipe	SDR 7.4/SDR 11	MF		PP-R
2070162 . . . 2070762	aquatherm blue pipe	SDR 7.4/SDR 11/SDR 17.6	MF	UV	PP-R
2170114 . . . 2170712	aquatherm blue pipe	SDR 7.4/SDR 11	MF	OT	PP-R
2570130 . . . 2570154	aquatherm blue pipe	SDR 17.6	MF		PP-R
2270111 . . . 2270142	aquatherm blue pipe	SDR 7.4/SDR 11	MF	TI	PP-R
2470711 . . . 2470126	aquatherm blue pipe	SDR 7.4/SDR 11	MF	OT-TI	PP-R

MANIFOLD CONSTRUCTION – CUSTOM MADE

We design and construct your manifolds in our company according to your specifications and dispatch them pre-finished to any place of the world.

You only have to send us the drawings and/or sketches with specifications. We return the offer including material list and drawing. A qualified team of experienced technicians likes to assist you.

For detailed information referring "manifold construction" please contact our technical hotline: +49 (0) 2722 950-200!

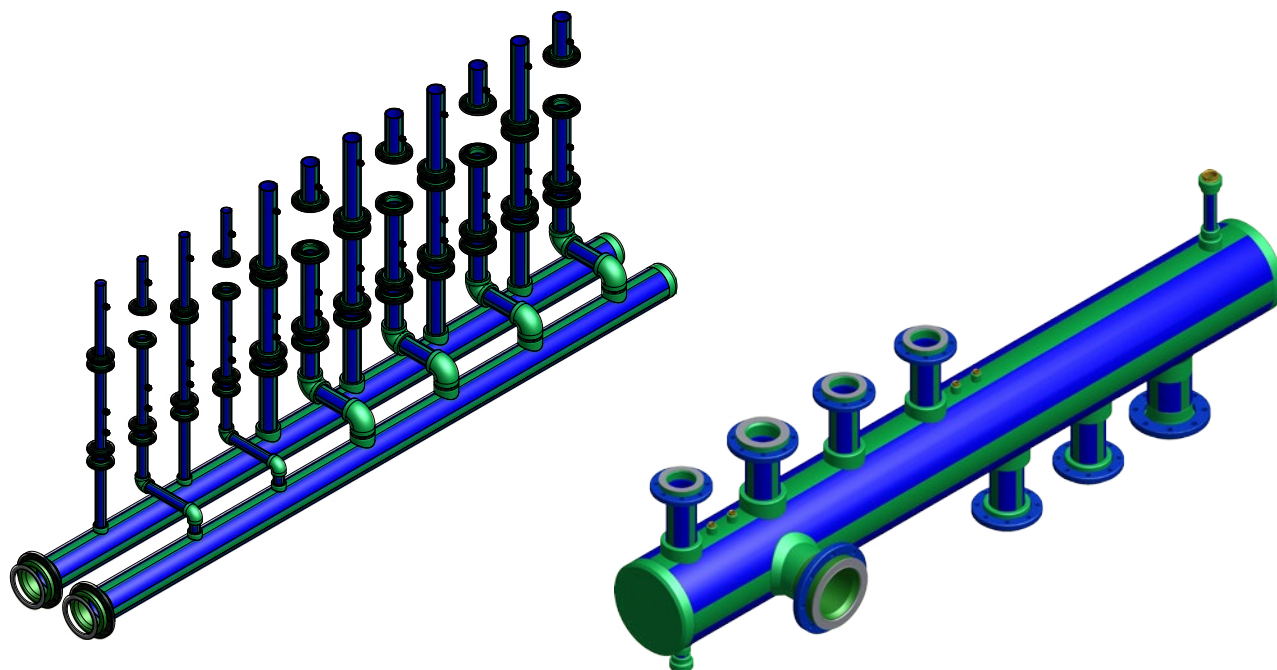

aquatherm blue pipe SDR 7.4 / 11 / 17.6 MF

Structure of pipe:	MF = multilayer, with fibre reinforced
Material:	fusiolen PP-R
Pipe series:	SDR 7.4 / S 3.2 & SDR11 / S 5 & SDR 17.6 / S 8.3
Standards:	SKZ HR 3.28, ASTM F 2389, CSA B 137.11, ISO 21003
Colour:	blue with 4 wider green stripes
Form supplied:	ø 20–125 mm straight lengths 4 m ø 160–630 mm straight lengths 5.8 m
Packing Unit:	PU in meter
Application:	

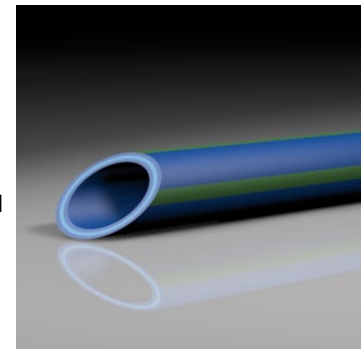
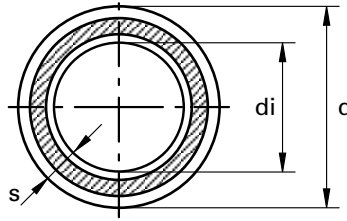

Mechanically stabilized through a fibre mix integrated in the middle layer of the fusiolen® PP-R.

SDR	Art. no.	Dimension d [mm]	Wall thickness s [mm]	Internal diameter di [mm]	Water content [l/m]	Weight [kg]	DN	PU [m]	Price € m/pc	
<i>Socket welding</i>										
7.4	2070708	20	2,8	14,4	0,163	0,157	15	100		
	2070710	25	3,5	18,0	0,254	0,244	20	100		
	2070712	32	4,4	23,2	0,423	0,391	25	40		
11	2070112	32	2,9	26,2	0,539	0,275	25	40		
	2070114	40	3,7	32,6	0,834	0,435	32	40		
	2070116	50	4,6	40,8	1,307	0,674	40	20		
	2070118	63	5,8	51,4	2,074	1,065	50	20		
	2070120	75	6,8	61,4	2,959	1,485	65	20		
	2070122	90	8,2	73,6	4,252	2,150	80	12		
	2070124	110	10,0	90,0	6,359	3,185	-	8		
	2070126	125	11,4	102,2	8,199	4,130	100	4		
	<i>Butt welding</i>									
		2070130	160	14,6	130,8	13,430	6,751	125	5.8	
	2070134	200	18,2	163,6	21,010	10,515	150	5.8		
	2070138	250	22,7	204,6	32,861	16,363	200	5.8		
	2070142	315	28,6	257,8	52,172	25,958	250	5.8		
	2070144	355	32,2	290,6	66,29	32,941	300	5.8		
	2070146	400	36,3	327,6	84,290	41,818	300	5.8		
	2070148	450	40,9	368,2	106,477	52,930	400	5.8		
17.6	<i>Socket welding</i>									
	2570126	125	7,1	110,8	9,637	2,697	100	4		
	<i>Butt welding</i>									
	2570130	160	9,1	141,8	15,792	4,574	150	5.8		
	2570134	200	11,4	177,2	24,661	7,081	200	5.8		
	2570138	250	14,2	221,6	38,568	10,949	250	5.8		
	2570142	315	17,9	279,2	61,223	17,245	300	5.8		
	2570144	355	20,1	314,8	77,832	21,806	350	5.8		
	2570146	400	22,7	354,6	98,756	27,638	350	5.8		
	2570148	450	25,5	399,0	125,036	34,858	400	5.8		
	2570150	500	28,4	443,2	154,272	43,048	450	5.8		
	2570152	560	31,7	496,6	193,688	53,706	500	5.8		
	2570154	630	35,7	558,6	245,070	67,917	500	5.8		

aquatherm blue pipe SDR 7.4/11/17.6 MF UV

- Structure of pipe:** MF = multilayer, with fibre reinforced
Special feature of pipe: UV resistant
Material: fusiolen PP-R
Pipe series: SDR 7.4/S 3.2 & SDR11/SDR 17.6 / S 8.3
Standards: SKZ HR 3.28, ASTM F 2389, CSA B 137.11, ISO 21003
Colour: outside: black, inside: blue
Form supplied: ø 20–125 mm straight lengths 4 m
 ø 160–630 mm straight lengths 5.8 m

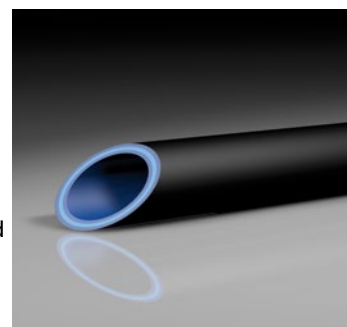
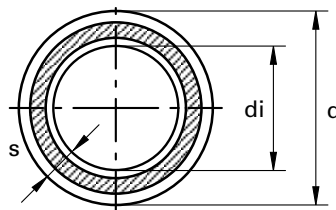
**Packing Unit:** PU in meter**Application:**

UV-resistant. Mechanically stabilized by a fibre mixture, integrated in the middle layer of fusiolen PP-R.

SDR	Art. no.	Dimension d [mm]	Wall thickness s [mm]	Internal diameter di [mm]	Water content [l/m]	Weight [kg]	DN	PU [m]	Price € m/pc	
<i>Socket welding</i>										
7.4	2070758	20	2,8	14,4	0,163	0,210	15	100		
	2070760	25	3,5	18,0	0,254	0,314	20	100		
	2070762	32	4,4	23,2	0,423	0,484	20	40		
11	2070162	32	2,9	26,2	0,539	0,368	25	40		
	2070164	40	3,7	32,6	0,834	0,555	32	40		
	2070166	50	4,6	40,8	1,307	0,827	40	20		
	2070168	63	5,8	51,4	2,074	1,260	50	20		
	2070170	75	6,8	61,4	2,959	1,712	65	20		
	2070172	90	8,2	73,6	4,252	2,491	80	12		
	2070174	110	10,0	90,0	6,359	3,693	-	8		
	2070176	125	11,4	102,2	8,199	4,774	100	4		
	<i>Butt welding</i>									
		2070180	160	14,6	130,8	13,430	7,051	125	5.8	
	2070184	200	18,2	163,6	21,010	10,845	150	5.8		
	2070188	250	22,7	204,6	32,861	16,681	200	5.8		
	2070192	315	28,6	257,8	52,172	26,217	250	5.8		
	2070194	355	32,2	290,6	66,292	33,153	300	5.8		
	2070196	400	36,3	327,4	84,145	41,937	300	5.8		
	2070198	450	40,9	368,2	106,423	52,997	400	5.8		
17.6	2570180	160	9,1	141,8	15,784	4,707	150	5.8		
	2570184	200	11,4	177,2	24,649	7,201	200	5.8		
	2570188	250	14,2	221,6	38,549	11,006	250	5.8		
	2570192	315	17,9	279,2	61,193	17,174	300	5.8		
	2570194	355	20,1	314,8	77,793	21,647	350	5.8		
	2570196	400	22,7	354,6	98,707	27,339	350	5.8		
	2570198	450	25,5	399,0	124,973	34,454	400	5.8		
	2570200	500	28,4	443,2	154,195	42,525	450	5.8		
	2570202	560	31,7	496,6	193,590	52,994	500	5.8		
	2570204	630	35,7	558,6	245,947	66,976	500	5.8		

aquatherm blue pipe SDR 7.4 / 11 MF OT

- Structure of pipe:** MF = multilayer, with fibre reinforced
Special feature of pipe: OT = oxygen tight
Material: fusiolen PP-R
Pipe series: SDR 7.4/S 3.2 & SDR11 / S 5
Standards: DIN 8077 / 78, DIN EN ISO 15874, ASTM F 2389, CSA B 137.11, ISO 21003
Colour: blue
Form supplied: ø 20–125 mm straight lengths 4 m
 ø 160–250 mm straight lengths 5,8 m
Packing Unit: PU in meter
Application:

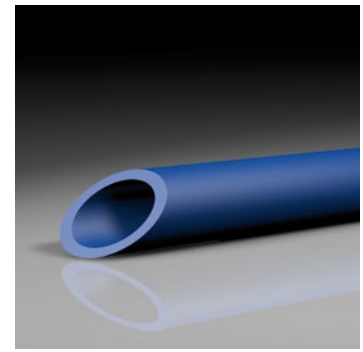
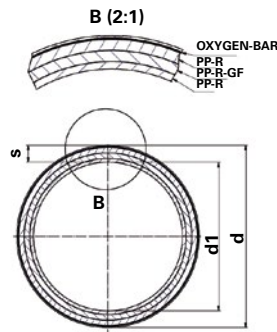

Oxygen tight by diffusion barrier. Mechanically stabilized through a fibre mix integrated in the middle layer of fusiolen® PP-R.

SDR	Art. no.	Dimension d [mm]	Wall thickness s [mm]	Internal diameter d1 [mm]	Water content [l/m]	Weight [kg]	DN	PU [m]	Price € m/pc
<i>Socket welding</i>									
7.4	2170708	20	2,8	14,4	0,163	0,211	15	100	
	2170710	25	3,5	18,0	0,254	0,316	20	100	
	2170712	32	4,4	23,2	0,423	0,488	20	40	
11	2170114	40	3,7	32,6	0,834	0,562	32	40	
	2170116	50	4,6	40,8	1,307	0,838	40	20	
	2170118	63	5,8	51,4	2,074	1,279	50	20	
	2170120	75	6,8	61,4	2,959	1,739	65	20	
	2170122	90	8,2	73,6	4,252	2,533	80	12	
11	2170124	110	10,0	90,0	6,359	3,752	-	8	
	2170126	125	11,4	102,2	8,199	4,857	100	4	
<i>Butt welding</i>									
	2170130	160	14,6	130,8	13,430	6,888	125	5.8	
	2170134	200	18,2	163,6	21,010	10,687	150	5.8	
	2170138	250	22,7	204,6	32,861	16,578	200	5.8	

aquatherm blue pipe SDR 11 S

- Structure of pipe:** S (single)
Material: fusiolen PP-R
Pipe series: SDR 11/S 5
Standards: DIN 8077 / 78, DIN EN ISO 15874, ASTM F 2389, CSA B 137.11, NSF 14, ISO 21003
Colour: blue
Form supplied: 4 m straight lengths, also* in coils
Packing Unit: PU in meter
Application:

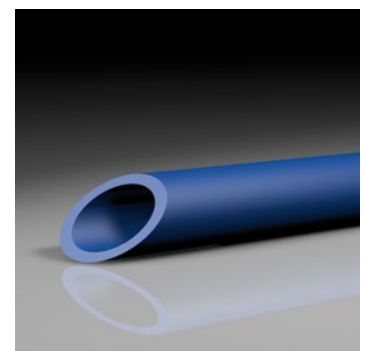
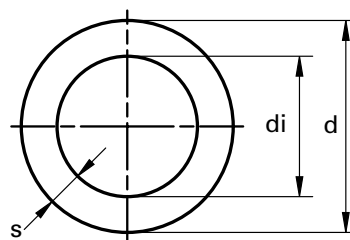

SDR	Art. no.	Dimension d [mm]	Wall thickness s [mm]	Internal diameter di [mm]	Water content [l/m]	Weight [kg]	DN	PU [m]	Price € m/pc
11	2010208	20	1,9	16,2	0,206	0,108	15	100	
	2010210	25	2,3	20,4	0,327	0,165	20	100	
	2010212	32	2,9	26,2	0,539	0,261	25	40	
	2010308*	20	1,9	16,2	0,206	0,108	15	100	
	2010310*	25	2,3	20,4	0,327	0,165	20	100	
	2010312*	32	2,9	26,2	0,539	0,261	25	50	

aquatherm lilac pipe

aquatherm lilac pipe was developed exclusively for the field of water recycling. In countries that are highly committed to the environment, like Australia and California, it is already standard to reduce daily water consumption by using recycled water when possible. Now lilac is also regarded in other countries as a standard colour for greywater pipes. For technical, commercial, agricultural or domestic applications, cost-effective process water is often required. In the private sector, water recycling-systems are increasingly used. Thanks to the long-lasting and corrosion-resistant material Polypropylene, the aquatherm lilac pipe is ideally suited for process water (grey/rainwater).

Pipe system made of polypropylene

for reclaimed

article no.	brand name	Standard Dimension Ratio	structure of pipe	material
9010808 . . . 9010226	aquatherm lilac pipe	SDR 7.4/SDR 11	S	PP-R

aquatherm lilac pipe SDR 7.4/11 S

Structure of pipe:	S (single)
Material:	fusiolen PP-R
Pipe series:	SDR 7.4 / S3.5 & SDR 11 / S 5
Standards:	DIN 8077/78, DIN EN ISO 15874, ASTM F 2389, CSA B 137.11, NSF 14
Colour:	lilac
Form supplied:	4 m straight lengths
Packing Unit:	PU in meter
Application:	

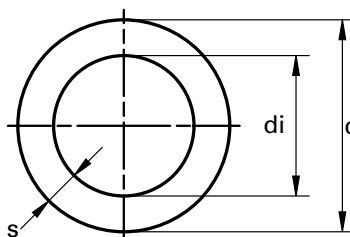

SDR	Art. no.	Dimension d [mm]	Wall thickness s [mm]	Internal diameter di [mm]	Water content [l/m]	Weight [kg]	DN	PU [m]	Price € m/pc
7.4	9010808	20	2,8	14,4	0,163	0,149	15	100	
	9010810	25	3,5	18,0	0,254	0,232	20	100	
11	9010212	32	2,9	26,2	0,539	0,261	25	40	
	9010214	40	3,7	32,6	0,834	0,414	32	40	
	9010216	50	4,6	40,8	1,307	0,641	40	20	
	9010218	63	5,8	51,4	2,074	1,012	50	20	
	9010220	75	6,8	61,4	2,959	1,411	65	20	
	9010222	90	8,2	73,6	4,252	2,042	80	12	
	9010224	110	10,0	90,0	6,359	3,026	-	8	
	9010226	125	11,4	102,2	8,199	3,924	100	4	

ADHESIVE TAPE TO PROTECT AGAINST UV-RADIATION

for aquatherm MF UV pipes

Art. no.	Dimension	PU	Price € m/pc
10871	50mm x 10m	1	

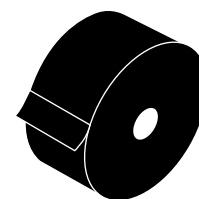

AQUATHERM PP-PRIMER

for aquatherm PP pipes

Art. no.	Dimension	PU	Box unit	Price € m/pc
50230		1l		
50231		10l		

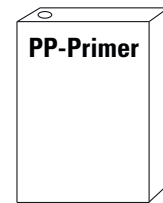

AQUATHERM SPECIAL TOP COAT

for aquatherm PP-pipes

Art. no.	Colour	PU	Box unit	Price € m/pc
50232	black	2,5l		
50233	white	2,5l		



PIPE CLAMPS

suitable for sliding and fixed point installation

Thread connection: M8 & M10 for 16–125 mm | M10 for 160 mm | M16 for 200–355 mm

Art. no.	for pipe dimension [mm]	PU	Box unit	Price € m/pc
60516	16	50		
60520	20	50		
60525	25	50		
60532	32	50		
60540	40	50		
60550	50	50		
60563	63	25		
60575	75	25		
60590	90	25		
60594	110	25		
60595	125	25		
60597	160	25		
60650	200	1		
60654	250	1		
60658	315	1		
60660	355	1		

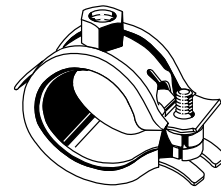

PIPE CLAMPS

suitable for fixed point installation

Art. no.	for pipe dimension [mm]	PU	Box unit	Price € m/pc
60768	160	1		
60770	200	1		
60774	250	1		
60778	315	1		
60780	355	1		
60782	400	1		
60784	450	1		
60786	500	1		
60788	560	1		
60790	630	1		

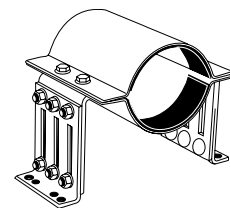

PIPE FASTENING BOW

suitable for \varnothing 16–32 mm pipes

Art. no.	for pipe dimension	PU	Box unit	Price € m/pc
60604	1-fold - length = 45mm	50		
60606	1-fold - length = 75mm	50		
60608	2-fold - length = 45mm	50		
60610	2-fold - length = 75 mm	50		

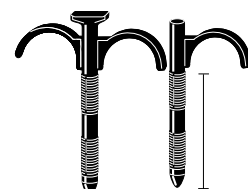

PLASTIC PIPE CLAMPS

suitable for \varnothing 16–40 mm pipes

Art. no.	for pipe dimension [mm]	PU	Box unit	Price € m/pc
60616	16	50		
60620	20	50		
60625	25	30		
60632	32	30		
60640	40	30		

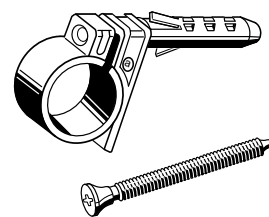

PIPE SUPPORT

Art. no.	for pipe dimension	PU	Box unit	Price € m/pc
85110	\varnothing 16x2,2mm - \varnothing 11,4mm	10		
10186	\varnothing 16x2,7mm - \varnothing 10,4mm	10		

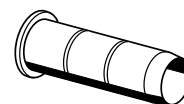

SOCKET

Systems: **aquatherm green pipe**, **aquatherm blue pipe**, **aquatherm lilac pipe**

Material: Fusiolen® PP-R

Standard: DIN 16962, DIN EN ISO 15874

Colour: green

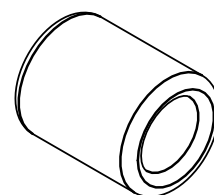
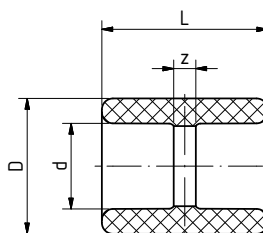

SDR	Art. no.	Dimension d [mm]	l [mm]	z [mm]	D [mm]	Weight [kg]	System	PU	Box unit	Price € m/pc
6 7.4 9 11 17.6	11006	16	30,0	4,0	24,5	0,008	•	10		
	11008	20	32,0	3,0	27,0	0,008	• • •	10	1900	
	11010	25	35,0	3,0	34,0	0,013	• • •	10	1000	
	11012	32	40,5	4,5	43,0	0,026	• • •	5	600	
	11014	40	47,5	6,5	52,0	0,044	• • •	5	400	
	11016	50	53,0	6,0	68,0	0,084	• • •	5	200	
	11018	63	60,5	5,5	84,0	0,139	• • •	1	100	
	11020	75	66,5	6,5	100,0	0,226	• • •	1	70	
	11022	90	72,5	6,5	120,0	0,343	• • •	1	50	
	11024	110	82,0	8,0	147,0	0,581	• • •	1	30	
	11026	125	92,0	12,0	167,0	0,845	• • •	1	25	

REDUCING SOCKET FEMALE/FEMALE

Systems: **aquatherm green pipe**, **aquatherm blue pipe**, **aquatherm lilac pipe**

Material: Fusiolen® PP-R

Standard: DIN 16962, DIN EN ISO 15874

Colour: green

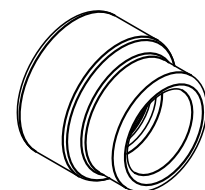
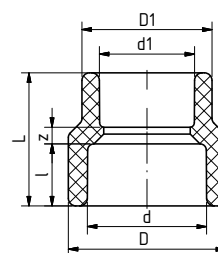

SDR	Art. no.	Dimension d [mm]	Dimension d1 [mm]	L [mm]	l [mm]	z [mm]	D [mm]	D1 [mm]	Weight [kg]	System	PU	Box unit	Price € m/pc
<i>double-sided socket welding</i>													
6 7.4 9 11 17.6	11222	40	32	44,0	20,5	5,5	52,0	43,0	0,035	• • •	1		
	11228	50	32	53,0	23,5	11,5	68,0	43,0	0,066	• • •	1		
	11230	50	40	50,5	23,5	6,3	68,0	52,0	0,069	• • •	1		
	11236	63	40	61,0	27,5	13,0	84,0	52,0	0,115	• • •	1		
	11238	63	50	56,0	27,5	5,0	84,0	68,0	0,120	• • •	1		
	11240	75	50	68,0	30,0	14,5	100,0	68,0	0,192	• • •	1		
	11242	75	63	62,5	30,0	5,0	100,0	84,0	0,185	• • •	1		
	11252	90	63	74,0	33,0	13,5	120,0	84,0	0,276	• • •	1		
	11253	90	75	69,0	33,0	6,0	120,0	100,0	0,297	• • •	1		
	11257	110	75	85,0	37,0	18,0	147,0	100,0	0,516	• • •	1		
	11259	110	90	77,3	37,0	7,3	147,0	120,0	0,520	• • •	1		
	11263	125	90	91,0	40,0	18,0	167,0	120,0	0,749	• • •	1		
	11265	125	110	87,0	40,0	10,0	167,0	147,0	0,726	• • •	1		

REDUCING SOCKET, SOCKET WELDING

Systems: aquatherm green pipe,
aquatherm blue pipe,
aquatherm lilac pipe

Material: Fusiolen® PP-R

Standard: DIN 16962, DIN EN ISO 15874

Colour: green

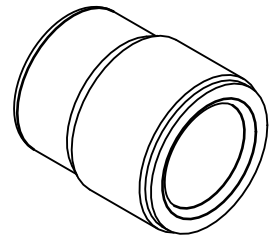
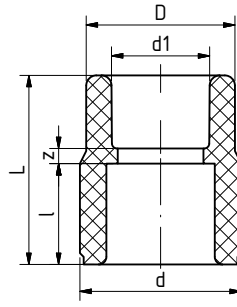

SDR	Art. no.	Dimension d [mm]	Dimension d1 [mm]	l [mm]	L [mm]	z [mm]	D [mm]	Weight [kg]	System	PU	Box unit	Price € m/pc
<i>double-sided socket welding</i>												
	11109	20	16	14,5	39,0	11,5	24,5	0,009	•	10	2000	
	11110	25	16	16,0	38,0	9,0	26,0	0,012	•	10	2000	
	11112	25	20	16,0	38,5	8,0	29,5	0,012	• • •	10	1500	
	11114	32	20	18,0	37,5	5,0	29,5	0,015	• • •	5	1000	
	11116	32	25	18,0	38,0	4,0	34,0	0,016	• • •	5	1000	
	11118	40	20	20,5	45,0	10,0	29,5	0,025	• • •	5	750	
	11120	40	25	20,5	50,0	13,5	34,0	0,028	• • •	5	600	
	11122	40	32	20,5	50,0	11,5	43,0	0,032	• • •	5	500	
	11124	50	20	23,5	55,0	17,0	29,5	0,045	• • •	5	500	
	11126	50	25	23,5	55,0	15,5	34,0	0,044	• • •	5	500	
	11128	50	32	23,5	54,0	12,5	43,0	0,048	• • •	5	350	
	11130	50	40	23,5	53,0	9,0	52,0	0,053	• • •	5	300	
	11131	63	20	27,5	65,0	23,0	29,5	0,073	• • •	1	200	
	11132	63	25	27,5	65,0	21,5	34,0	0,071	• • •	1	200	
6	11134	63	32	27,5	62,0	16,5	43,0	0,080	• • •	1	200	
7.4	11136	63	40	27,5	64,5	16,5	52,0	0,089	• • •	1	200	
9	11138	63	50	27,5	63,5	12,5	68,0	0,107	• • •	1	150	
11	11139	75	40	30,0	69,5	19,0	52,0	0,131	• • •	1		
17.6	11140	75	50	30,0	63,0	9,5	68,0	0,141	• • •	1		
	11142	75	63	30,0	71,0	13,5	84,0	0,170	• • •	1		
	11143	75	20	30,0	65,5	21,0	34,5	0,113	• • •	1		
	11144	75	25	30,0	65,5	19,5	34,5	0,111	• • •	1		
	11145	75	32	30,0	69,5	21,5	52,0	0,140	• • •	1		
	11151	90	50	33,0	75,0	18,5	68,0	0,193	• • •	1		
	11152	90	63	33,0	78,0	17,5	84,0	0,224	• • •	1		
	11153	90	75	33,0	81,5	18,5	100,0	0,273	• • •	1		
	11155	110	63	37,0	86,0	21,5	84,0	0,356	• • •	1		
	11157	110	75	37,0	89,0	22,0	100,0	0,383	• • •	1		
	11159	110	90	37,0	99,0	29,0	120,0	0,500	• • •	1		
	11161	125	75	40,0	101,0	31,0	100,0	0,518	• • •	1		
	11163	125	90	40,0	99,0	26,0	120,0	0,588	• • •	1		
	11165	125	110	40,0	112,0	35,0	147,0	0,832	• • •	1		

REDUCING SOCKET, SOCKET & BUTT WELDING

Systems: **aquatherm green pipe,**
aquatherm blue pipe

Material: Fusiolen® PP-R & PP-RP

Standard: DIN 16962, DIN EN ISO 15874

Colour: green

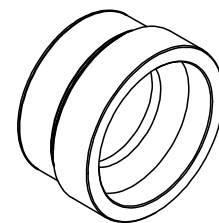
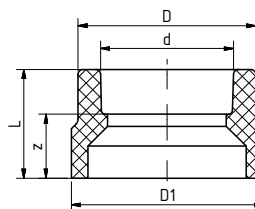

SDR	Art. no.	D1 [mm]	Dimension d [mm]	L [mm]	z [mm]	D [mm]	Weight [kg]	System	PU	Box unit	Price € m/pc
<i>onesided socket welding, other side butt welding</i>											
7.4	11174	160	110	90,0	53,0	147,0	0,730	•	1		
	11176	160	125	90,0	50,0	167,0	0,837	•	1		
	11182	200	125	135,0	95,0	167,0	1,644	•	1		
9	311174	160	110	90,0	53,0	147,0	0,730	•	1		
	311176	160	125	90,0	50,0	167,0	0,868	•	1		
	311182	200	125	135,0	95,0	167,0	1,599	•	1		
11	11175	160	110	90,0	53,0	147,0	0,655	• •	1		
	11177	160	125	90,0	50,0	167,0	0,636	• •	1		
	11183	200	125	135,0	95,0	167,0	1,341	• •	1		
17.6	2511174	160	110	90,0	53,0	147,0	0,618	•	1		
	2511176	160	125	90,0	50,0	167,0	0,628	•	1		
	2511182	200	125	135,0	95,0	167,0	1,055	•	1		

REDUCING SOCKET, BUTT WELDING

Systems: **aquatherm green pipe,**
aquatherm blue pipe

Material: Fusiolen® PP-R & PP-RP

Standard: DIN 16962, DIN EN ISO 15874

Colour: green

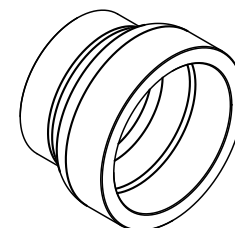
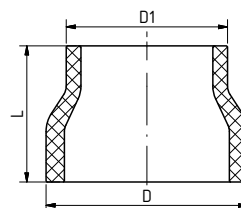

SDR	Art. no.	D [mm]	D1 [mm]	L [mm]	Weight [kg]	System	PU	Box unit	Price € m/pc
<i>double-sided butt welding</i>									
7.4	11184	200	160	135,0	1,638	•	1		
	11188	250	160	172,5	2,881	•	1		
	11190	250	200	172,5	3,250	•	1		
9	311184	200	160	135,0	1,588	•	1		
	311188	250	160	172,5	2,900	•	1		
	311190	250	200	172,5	3,206	•	1		
	311192	315	200	225,0	6,350	•	1		
	311194	315	250	225,0	7,050	•	1		
	311196	355	250	170,0	5,640	•	1		
311198	355	315	160,0	4,940	•	1			
11	11185	200	160	135,0	1,206	• •	1		
	11189	250	160	172,5	2,313	• •	1		
	11191	250	200	172,5	2,389	• •	1		
	11193	315	200	225,0	4,389	• •	1		
	11195	315	250	225,0	4,690	• •	1		
	11197	355	250	170,0	4,510	• •	1		
	11199	355	315	160,0	4,635	• •	1		
	11201	400	250	152,0	5,160	• •	1		
	11203	400	315	122,0	4,550	• •	1		
	11204	400	355	110,0	4,620	• •	1		
11206	450	315	142,0	6,500	• •	1			
11207	450	355	132,0	6,500	• •	1			
11208	450	400	122,0	6,000	• •	1			

REDUCING SOCKET, BUTT WELDING

Systems: aquatherm blue pipe
Material: Fusiolen® PP-R
Standard: DIN 16962, DIN EN ISO 15874
Colour: green

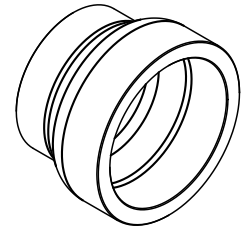
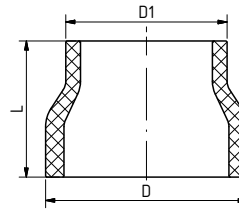

SDR	Art. no.	D [mm]	D1 [mm]	L [mm]	Weight [kg]	System	PU	Box unit	Price € m/pc
<i>double-sided butt welding</i>									
17.6	2511184	200	160	135,0	1,012	•	1		
	2511188	250	160	172,5	1,500	•	1		
	2511190	250	200	172,5	1,338	•	1		
	2511193	315	200	225,0	4,141	•	1		
	2511195	315	250	225,0	3,420	•	1		
	2511197	355	250	170,0	4,480	•	1		
	2511199	355	315	160,0	3,108	•	1		
	2511201	400	250	152,0	3,240	•	1		
	2511203	400	315	122,0	3,000	•	1		
	2511204	400	355	112,0	2,500	•	1		
	2511206	450	315	142,0	4,000	•	1		
	2511207	450	355	132,0	4,000	•	1		
	2511208	450	400	122,0	4,000	•	1		
	2511209	500	315	172,0	6,500	•	1		
	2511210	500	355	152,0	7,000	•	1		
	2511211	500	400	142,0	6,500	•	1		
	2511212	500	450	122,0	5,500	•	1		
	2511213	560	400	162,0	9,500	•	1		
	2511214	560	450	142,0	8,000	•	1		
	2511215	560	500	132,0	7,500	•	1		
2511216	630	400	192,0	14,500	•	1			
2511217	630	450	172,0	12,500	•	1			
2511218	630	500	152,0	11,000	•	1			
2511219	630	560	132,0	9,000	•	1			

ELBOW 90°

Systems: aquatherm green pipe,
aquatherm blue pipe,
aquatherm lilac pipe
Material: Fusiolen® PP-R
Standard: DIN 16962, DIN EN ISO 15874
Colour: green

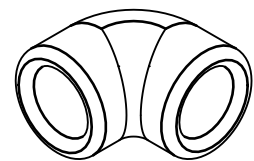
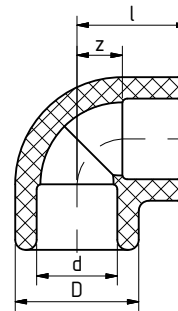

SDR	Art. no.	Dimension d [mm]	z [mm]	l [mm]	D [mm]	Weight [kg]	System	PU	Box unit	Price € m/pc
<i>socket welding</i>										
6 7.4 9 11 17.6	12106	16	9,0	22,0	24,5	0,010	•	10	2000	
	12108	20	11,0	25,5	27,0	0,013	• • •	10	1400	
	12110	25	13,5	29,5	34,0	0,023	• • •	10	800	
	12112	32	17,0	35,0	43,0	0,043	• • •	5	400	
	12114	40	21,0	41,5	52,0	0,077	• • •	5	250	
	12116	50	26,0	49,5	68,0	0,162	• • •	5	125	
	12118	63	32,5	60,0	84,0	0,293	• • •	1	75	
	12120	75	38,5	68,5	100,0	0,445	• • •	1	40	
	12122	90	46,0	79,0	120,0	0,729	• • •	1	25	
	12124	110	56,0	93,0	147,0	1,292	• • •	1		
	12126	125	76,5	116,5	167,0	2,004	• • •	1		

ELBOW 90° BUTT WELDING

Systems: aquatherm green pipe, aquatherm blue pipe

Material: Fusiolen® PP-R & PP-RP

Standard: DIN 16962, DIN EN ISO 15874

Notice There is a gradual conversion of the XXL-fittings made of pipe segments to an injection molded design. The table shows which articles are already available in new design at the time of printing this catalogue. In the aquatherm technews we will inform you of further changes, but first the current stock of the elbows made of pipe segments has to be sold.

All fittings, which are converted to the injection molding production, are still available on inquiry as special fittings made of pipe segments. No article numbers are defined for special fittings of any type.

Please note! Electrofusion sockets can not be processed directly with injection molded fittings. When using electrofusion sockets either segment welded special fittings must be used or pipe pieces must be welded to the injection molded fittings.

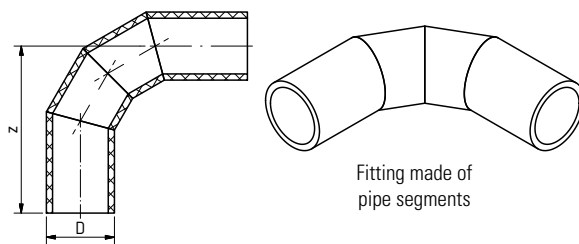

Fitting made of pipe segments

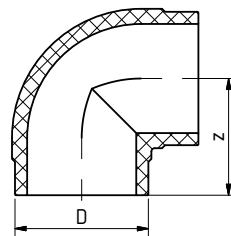

Injection molded fitting
Colour: green

SDR	Art. no.	D [mm]	z [mm]	Weight [kg]	System	pipe segments	NEW		PU	Box unit	Price € m/pc
							injection molded*	(green)			
<i>butt welding</i>											
7.4	12130	160	145,0	2,561	•		•		1		
	12134	200	450,0	11,685	•	•			1		
	12138	250	625,0	26,000	•	•			1		
9	312130	160	145,0	2,371	•		•		1		
	312134	200	209,0	4,320	•		•		1		
	312138	250	240,0	8,500	•		•		1		
	312142	315	773,0	42,300	•	•			1		
	312144	355	833,0	57,628	•	•			1		
11	12131	160	145,0	2,145	•	•	•		1		
	12135	200	209,0	4,653	•	•	•		1		
	12139	250	240,0	7,180	•	•	•		1		
	12143	315	773,0	37,850	•	•	•		1		
	12145	355	833,0	49,000	•	•	•		1		
	12147	400	900,0	62,800	•	•	•		1		
	12149	450	975,0	89,500	•	•	•		1		
<i>¹⁾ mechanically stabilized through a fibre mix integrated in the middle layer of the fusiolen® PP-R</i>											
11	2012143	315	773,0	37,300		•	•		1		
	2012145	355	833,0	57,074		•	•		1		
	2012147	400	900,0	74,500		•	•		1		
	2012149	450	975,0	89,080		•	•		1		
17.6	2512130	160	145,0	1,642		•	•		1		
	2512134	200	209,0	3,640		•	•		1		
	2512138	250	240,0	6,200		•	•		1		
	2512142	315	773,0	24,000		•	•		1		
	2512144	355	833,0	32,000		•	•		1		
	2512146	400	900,0	42,549		•	•		1		
	2512148	450	975,0	62,200		•	•		1		
	2512150	500	1100,0	91,000		•	•		1		
	2512152	560	1190,0	108,779		•	•		1		
	2512154	630	1295,0	164,600		•	•		1		

* status quo at the time of printing, further injection molded parts follow

ELBOW 90° FEMALE/MALE

Systems: aquatherm green pipe,
aquatherm blue pipe,
aquatherm lilac pipe

Material: Fusiolen® PP-R

Standard: DIN 16962, DIN EN ISO 15874

Colour: green

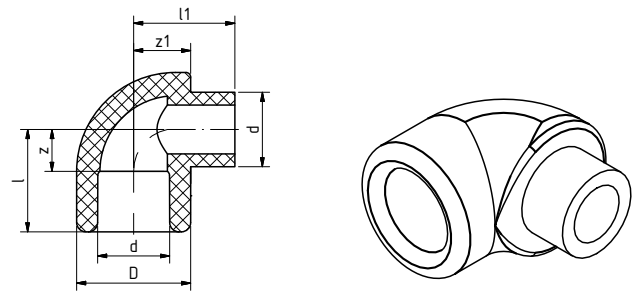

SDR	Art. no.	Dimension d [mm]	z [mm]	l [mm]	D [mm]	l1 [mm]	z1 [mm]	Weight [kg]	System	PU	Box unit	Price € m/pc
<i>socket welding</i>												
6 7.4 9 11	12306	16	9,0	22,0	24,5	21,8	12,3	0,010	•	10	2000	
	12308	20	11,0	25,5	27,0	25,5	13,5	0,032	• • •	10	1200	
	12310	25	13,5	29,5	34,0	29,5	17,0	0,023	• • •	10	800	
	12312	32	17,0	35,0	43,0	39,0	21,5	0,048	• • •	5	400	
	12314	40	21,0	41,5	52,0	45,5	26,0	0,080	• • •	5	300	

ELBOW 45° FEMALE/MALE

Systems: aquatherm green pipe,
aquatherm blue pipe,
aquatherm lilac pipe

Material: Fusiolen® PP-R

Standard: DIN 16962, DIN EN ISO 15874

Colour: green

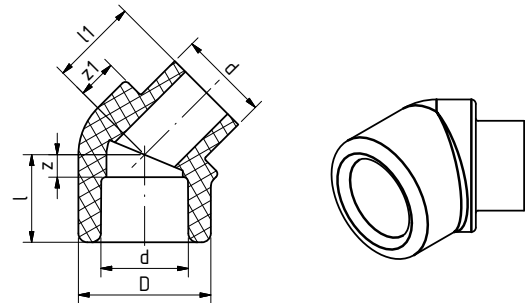

SDR	Art. no.	Dimension d [mm]	z [mm]	l [mm]	D [mm]	l1 [mm]	z1 [mm]	Weight [kg]	System	PU	Box unit	Price € m/pc
<i>socket welding</i>												
6 7.4 9 11	12708	20	5,0	19,5	29,5	19,5	9,0	0,013	• • •	10	1500	
	12710	25	6,0	22,0	34,0	22,0	8,5	0,017	• • •	10	1000	
	12712	32	7,5	25,5	43,0	29,0	11,5	0,036	• • •	5	500	
	12714	40	9,5	30,0	52,0	33,0	13,5	0,057	• • •	5	300	

ELBOW 45° SOCKET WELDING

Systems: aquatherm green pipe,
aquatherm blue pipe,
aquatherm lilac pipe

Material: Fusiolen® PP-R

Standard: DIN 16962, DIN EN ISO 15874

Colour: green

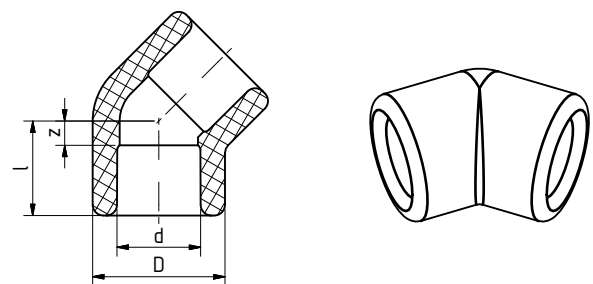

SDR	Art. no.	Dimension d [mm]	z [mm]	l [mm]	D [mm]	Weight [kg]	System	PU	Box unit	Price € m/pc
<i>socket welding</i>										
6 7.4 9 11 17.6	12506	16	4,5	17,5	24,5	0,009	•	10	2000	
	12508	20	5,0	19,5	29,5	0,014	• • •	10	1500	
	12510	25	6,0	22,0	34,0	0,018	• • •	10	1000	
	12512	32	7,5	25,5	43,0	0,035	• • •	5	500	
	12514	40	9,5	30,0	52,0	0,053	• • •	5	300	
	12516	50	11,5	35,0	68,0	0,112	• • •	5	150	
	12518	63	14,0	41,5	84,0	0,227	• • •	1	75	
	12520	75	16,5	46,5	100,0	0,350	• • •	1	60	
	12522	90	19,5	52,5	120,0	0,568	• • •	1	30	
	12524	110	23,5	60,5	147,0	1,025	• • •	1	20	
	12526	125	27,0	67,0	167,0	1,329	• • •	1		

ELBOW 45° BUTT WELDING

Systems: aquatherm green pipe, aquatherm blue pipe
Material: Fusiolen® PP-R & PP-RP
Standard: DIN 16962, DIN EN ISO 15874

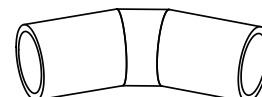
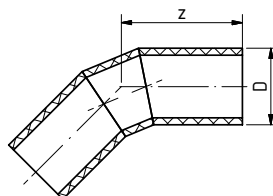

Fitting made of pipe segments

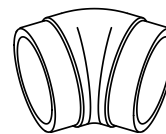

Injection molded fitting
Colour: green

Notice

There is a gradual conversion of the XXL-fittings made of pipe segments to an injection molded design. The table shows which articles are already available in new design at the time of printing this catalogue. In the aquatherm technews we will inform you of further changes, but first the current stock of the elbows made of pipe segments has to be sold. All fittings, which are converted to the injection molding production, are still available on inquiry as special fittings made of pipe segments. No article numbers are defined for special fittings of any type.

Please note! Electrofusion sockets can not be processed directly with injection molded fittings. When using electrofusion sockets either segment welded special fittings must be used or pipe pieces must be welded to the injection molded fittings.

NEW

SDR	Art. no.	D [mm]	z [mm]	Weight [kg]	System	pipe segments	injection molded*	PU	Box unit	Price € m/pc
<i>butt welding</i>										
7.4	12530	160	95,0	1,903	•		•	1		
	12534	200	274,0	8,175	•		•	1		
	12538	250	412,0	20,500	•		•	1		
9	312530	160	95,0	4,230	•		•	1		
	312534	200	146,0	7,500	•		•	1		
	312538	250	182,0	17,000	•		•	1		
	312542	315	498,0	30,567	•	•		1		
	312544	355	520,0	40,771	•	•		1		
11	12531	160	95,0	1,393	•	•	•	1		
	12535	200	146,0	3,408	•	•	•	1		
	12539	250	182,0	13,500	•	•	•	1		
	12543	315	498,0	27,300	•		•	1		
	12545	355	520,0	26,650	•		•	1		
	12547 ¹⁾	400	548,0	44,900	•		•	1		
	12549 ¹⁾	450	580,0	60,500	•		•	1		
¹⁾ mechanically stabilized through a fibre mix integrated in the middle layer of the fusiolen® PP-R										
11	2012543	315	498,0	27,100		•	•	1		
	2012545	355	520,0	38,158		•	•	1		
	2012547	400	548,0	44,712		•	•	1		
	2012549	450	580,0	60,260		•	•	1		
17.6	2512530	160	95,0	1,080		•	•	1		
	2512534	200	146,0	1,990		•	•	1		
	2512538	250	182,0	3,875		•	•	1		
	2512542	315	498,0	18,000		•	•	1		
	2512544	355	520,0	22,058		•	•	1		
	2512546	400	548,0	30,800		•	•	1		
	2512548	450	580,0	39,123		•	•	1		
	2512550	500	665,0	55,112		•	•	1		
	2512552	560	698,0	72,519		•	•	1		
	2512554	630	741,0	97,148		•	•	1		

* status quo at the time of printing, further injection molded parts follow

T-PIECE SOCKET WELDING

Systems: aquatherm green pipe, aquatherm blue pipe, aquatherm lilac pipe
Material: Fusiolen® PP-R
Standard: DIN 16962, DIN EN ISO 15874
Colour: green
Form: injection moulded fittings

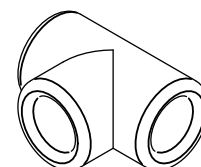
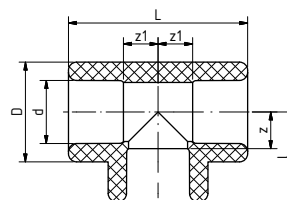

SDR	Art. no.	Dimension d [mm]	z [mm]	z1 [mm]	l [mm]	L [mm]	D [mm]	Weight [kg]	System	PU	Box unit	Price € m/pc
<i>socket welding</i>												
6	13106	16	9,0	9,0	22,0	44,0	24,5	0,015	•	10	1500	
	13108	20	11,0	11,0	25,5	51,0	27,0	0,017	•	10	1000	
	13110	25	14,5	15,0	30,5	62,0	34,0	0,033	•	10	500	
7.4	13112	32	15,5	17,0	33,5	70,0	43,0	0,054	•	5	300	
	13114	40	20,0	20,0	40,5	81,0	52,0	0,099	•	5	200	
9	13116	50	26,0	26,0	49,5	99,0	68,0	0,177	•	5	100	
11	13118	63	32,5	32,5	60,0	120,0	84,0	0,368	•	1	50	
17.6	13120	75	38,5	38,5	68,5	137,0	100,0	0,541	•	1	30	
	13122	90	47,0	46,0	80,0	158,0	120,0	0,920	•	1	25	
	13124	110	56,0	56,0	93,0	186,0	147,0	1,598	•	1	14	
	13126	125	76,5	76,5	116,5	233,0	167,0	2,673	•	1		

T-PIECE BUTT WELDING

Systems: aquatherm green pipe,
aquatherm blue pipe

Material: Fusiolen® PP-R & PP-RP

Standard: DIN 16962, DIN EN ISO 15874

Notice There is a gradual conversion of the XXL-fittings made of pipe segments to an injection molded design. The table shows which articles are already available in new design at the time of printing this catalogue. In the aquatherm technews we will inform you of further changes, but first the current stock of the t-pieces made of pipe segments has to be sold.

All fittings, which are converted to the injection molding production, are still available on inquiry as special fittings made of pipe segments. No article numbers are defined for special fittings of any type.

Please note! Electrofusion sockets can not be processed directly with injection molded fittings. When using electrofusion sockets either segment welded special fittings must be used or pipe pieces must be welded to the injection molded fittings.

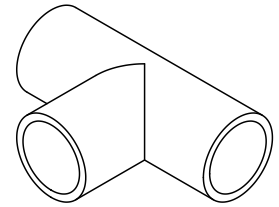
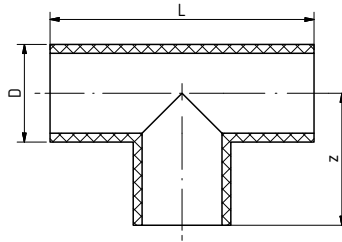

Fitting made of pipe segments

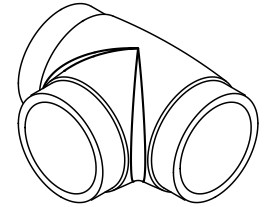
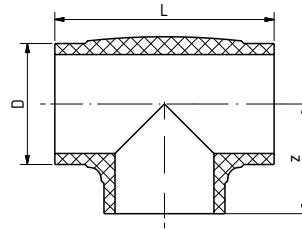

Injection molded fitting
Colour: green

NEW

SDR	Art. no.	D [mm]	L [mm]	z [mm]	Weight [kg]	System	pipe segments	injection molded* (green)	PU	Box unit	Price € m/pc
<i>butt welding</i>											
7.4	13130	160	290,0	145,0	3,600	•		•		1	
	13134	200	500,0	250,0	9,825	•	•			1	
	13138	250	750,0	375,0	24,000	•	•			1	
9	313130	160	290,0	145,0	3,290	•		•		1	
	313134	200	410,0	205,0	7,000	•		•		1	
	313138	250	486,0	243,0	12,500	•		•		1	
	313142	315	920,0	460,0	42,609	•	•			1	
	313144	355	960,0	480,0	56,452	•	•			1	
11	13131	160	290,0	145,0	3,005	•	•	•		1	
	13135	200	410,0	205,0	6,255	•	•	•		1	
	13139	250	486,0	243,0	10,710	•	•	•		1	
	13143	315	920,0	460,0	20,450	•	•			1	
	13145	355	960,0	480,0	45,072	•	•			1	
	13147 ¹⁾	400	1000,0	500,0	63,100	•	•			1	
	13149 ¹⁾	450	1050,0	525,0	83,300	•	•			1	
¹⁾ mechanically stabilized through a fibre mix integrated in the middle layer of the fusiolen® PP-R											
11	2013143	315	920,0	460,0	36,674		•	•		1	
	2013145	355	960,0	480,0	40,000		•	•		1	
	2013147	400	1000,0	500,0	62,100		•	•		1	
	2013149	450	1050,0	525,0	82,792		•	•		1	
17.6	2513130	160	290,0	145,0	2,348		•	•		1	
	2513134	200	410,0	205,0	4,500		•	•		1	
	2513138	250	486,0	243,0	9,000		•	•		1	
	2513142	315	920,0	460,0	19,800		•			1	
	2513144	355	960,0	480,0	27,500		•	•		1	
	2513146	400	1000,0	500,0	40,395		•	•		1	
	2513148	450	1050,0	525,0	45,400		•	•		1	
	2513150	500	1200,0	600,0	75,726		•	•		1	
	2513152	560	1260,0	630,0	99,320		•	•		1	
	2513154	630	1330,0	665,0	122,500		•	•		1	

* status quo at the time of printing, further injection molded parts follow

aquatherm blue pipe Y-PIECES

Special fittings on demand

ATTENTION – PLEASE NOTE!

These branches are for special applications in the **unpressurized** areas, e.g. in vacuum dewatering in the ship building. **In no case** they may be exposed to the pressures, given in the working pressure tables on page 25–27.

Systems: aquatherm green pipe,
aquatherm blue pipe,
aquatherm lilac pipe

Material: Fusiolen® PP-R

Standard: DIN16962-2

Color: blue/green

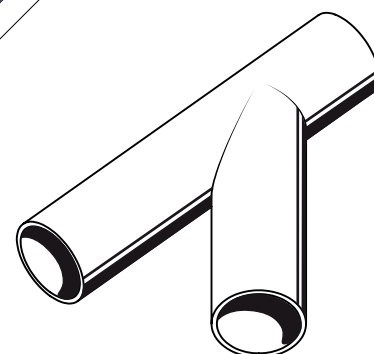
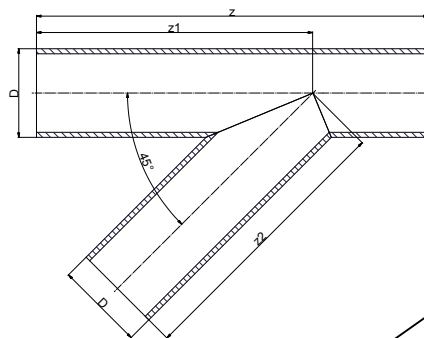

SDR	Art. no.	Dimension D [mm]	z [mm]	z1 [mm]	z2 [mm]	Weight [kg]	System	PU	Box unit	Price € m/pc	
<i>Socket welding</i>											
11	2013018	63	560,0	380,0	380,0	0,001	• • •	1			
	2013020	75	570,0	405,0	405,0	1,210	• • •	1			
	2013022	90	577,0	412,0	412,0	1,750	• • •	1			
	2013024	110	610,0	435,0	435,0	2,730	• • •	1			
	2013026	125	665,0	475,0	475,0	3,840	• • •	1			
	<i>Butt welding</i>										
	2013031	160	782,0	551,0	551,0	7,300	• •	1			
	2013035	200	925,0	650,0	650,0	13,360	• •	1			
	2013039	250	1105,0	780,0	780,0	24,780	• •	1			
<i>Socket welding</i>											
17.6	2513026	125	665,0	475,0	475,0	2,470	• •	1			
	<i>Butt welding</i>										
	2513030	160	782,0	551,0	551,0	4,700	• •	1			
	2513034	200	925,0	650,0	650,0	8,640	• •	1			
	2513038	250	1105,0	780,0	780,0	16,010	• •	1			

RED.-T-PIECE, SOCKET WELDING

Systems: aquatherm green pipe,
aquatherm blue pipe,
aquatherm lilac pipe

Material: Fusiolen® PP-R

Standard: DIN 16962, DIN EN ISO 15874

Colour: green

Form: injection moulded fittings

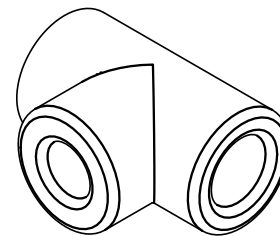
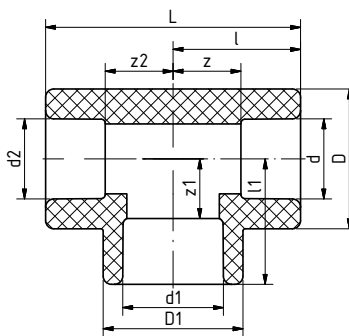

SDR	Art. no.	d [mm]	d1 [mm]	d2 [mm]	L [mm]	l [mm]	l1 [mm]	z [mm]	z1 [mm]	z2 [mm]	D [mm]	D1 [mm]	Weight [kg]	System	PU	Box unit	Price € m/pc
<i>socket welding</i>																	
	13506	20	16	16	51,0	25,5	25,3	11,0	12,3	12,5	29,5	29,5	0,025	•		10	
	13508	20	16	20	51,0	25,5	25,3	11,0	12,3	11,0	29,5	29,5	0,024	•		10	
	13510	20	20	16	51,0	25,5	25,3	11,0	10,8	12,5	29,5	29,5	0,023	•		10	
	13511	20	25	20	62,0	31,0	30,5	16,5	14,5	16,5	34,0	34,0	0,040	• • •		10	
	13512	25	16	16	62,0	31,0	30,5	15,0	17,5	18,0	34,0	34,0	0,043	•		10	
	13514	25	16	20	62,0	31,0	30,5	15,0	17,5	16,5	34,0	34,0	0,041	•		10	
	13516	25	16	25	62,0	31,0	30,5	15,0	17,5	15,0	34,0	34,0	0,038	•		10	
	13520	25	20	20	62,0	31,0	30,5	15,0	16,0	16,5	34,0	34,0	0,039	• • •		10	500
	13522	25	20	25	62,0	31,0	30,5	15,0	16,0	15,0	34,0	34,0	0,036	• • •		10	500
	13528	32	16	32	70,0	35,0	31,0	17,0	18,0	17,0	43,0	29,5	0,053	• • •		5	300
	13532	32	20	20	73,5	36,8	37,0	18,8	22,5	22,3	43,0	43,0	0,076	• • •		5	300
	13534	32	20	32	70,0	35,0	31,0	17,0	16,5	17,0	43,0	29,5	0,053	• • •		5	300
	13538	32	25	25	70,0	35,0	34,5	17,0	18,5	19,0	43,0	43,0	0,069	• • •		5	
	13540	32	25	32	70,0	35,0	32,0	17,0	16,0	17,0	43,0	34,0	0,050	• • •		5	300
	13542	40	20	40	83,0	41,5	36,0	21,0	21,5	21,0	52,0	34,0	0,091	• • •		5	200
	13544	40	25	40	83,0	41,5	36,0	21,0	20,0	21,0	52,0	34,0	0,089	• • •		5	200
	13546	40	32	40	84,0	42,0	40,5	21,5	22,5	21,5	52,0	52,0	0,092	• • •		5	200
	13547	50	20	50	99,0	49,5	40,5	26,0	26,0	26,0	68,0	29,5	0,162	• • •		5	100
	13548	50	25	50	99,0	49,5	44,5	26,0	28,5	26,0	68,0	34,0	0,158	• • •		5	100
6	13550	50	32	50	99,0	49,5	44,5	26,0	26,5	26,0	68,0	43,0	0,160	• • •		5	100
7.4	13551	50	40	50	99,0	49,5	49,5	26,0	29,0	26,0	68,0	68,0	0,161	• • •		5	100
9	13552	63	20	63	120,0	60,0	48,5	32,5	34,0	32,5	84,0	34,0	0,335	• • •		1	50
11	13554	63	25	63	120,0	60,0	48,5	32,5	32,5	32,5	84,0	34,0	0,331	• • •		1	50
17.6	13556	63	32	63	120,0	60,0	53,5	32,5	35,5	32,5	84,0	52,0	0,340	• • •		1	50
	13558	63	40	63	120,0	60,0	53,5	32,5	33,0	32,5	84,0	52,0	0,332	• • •		1	50
	13560	63	50	63	120,0	60,0	60,0	32,5	36,5	32,5	84,0	68,0	0,398	• • •		1	
	13561	75	20	75	137,0	68,5	54,5	38,5	40,0	38,5	100,0	34,0	0,501	• • •		1	
	13562	75	25	75	137,0	68,5	54,5	38,5	38,5	38,5	100,0	34,0	0,497	• • •		1	
	13564	75	32	75	137,0	68,5	59,0	38,5	41,0	38,5	100,0	52,0	0,505	• • •		1	
	13566	75	40	75	137,0	68,5	59,0	38,5	38,5	38,5	100,0	52,0	0,497	• • •		1	
	13568	75	50	75	137,0	68,5	66,0	38,5	42,5	38,5	100,0	84,0	0,550	• • •		1	
	13570	75	63	75	137,0	68,5	66,0	38,5	38,5	38,5	100,0	84,0	0,515	• • •		1	
	13576	90	32	90	158,0	79,0	65,0	46,0	47,0	46,0	120,0	52,0	0,880	• • •		1	
	13578	90	40	90	158,0	79,0	65,0	46,0	44,5	46,0	120,0	52,0	0,862	• • •		1	
	13580	90	50	90	158,0	79,0	75,0	46,0	51,5	46,0	120,0	84,0	0,905	• • •		1	
	13582	90	63	90	158,0	79,0	75,0	46,0	47,5	46,0	120,0	84,0	0,876	• • •		1	
	13584	90	75	90	158,0	79,0	81,0	46,0	51,0	46,0	120,0	120,0	0,991	• • •		1	
	13586	110	63	110	186,0	93,0	87,5	56,0	60,0	56,0	147,0	110,0	1,534	• • •		1	
	13588	110	75	110	186,0	93,0	87,5	56,0	57,5	56,0	147,0	110,0	1,517	• • •		1	
	13590	110	90	110	186,0	93,0	89,0	56,0	56,0	56,0	147,0	120,0	1,548	• • •		1	
	13592	125	75	125	233,0	116,5	106,5	76,5	76,5	76,5	167,0	100,0	2,427	• • •		1	
	13594	125	90	125	233,0	116,5	109,5	76,5	76,5	76,5	167,0	120,0	2,509	• • •		1	
	13596	125	110	125	233,0	116,5	113,5	76,5	76,5	76,5	167,0	147,0	2,563	• • •		1	

RED.-T-PIECE, SOCKET- & BUTT WELDING

Systems: aquatherm green pipe, aquatherm blue pipe
Standard: DIN 16962, DIN EN ISO 15874
Colour: green
Form: see table

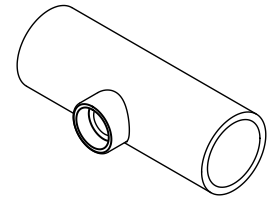
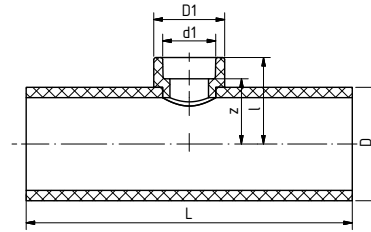

Fitting made of pipe segments

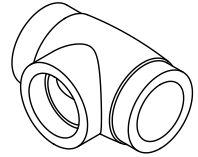

Injection molded fitting

Note: There is a gradual conversion of the XXL-fittings made of pipe segments to an injection molded design. The table shows which articles are already available in new design at the time of printing this catalogue. In the aquatherm technews we will inform you of further changes, but first the current stock of the red.-t-pieces made of pipe segments has to be sold.

All fittings, which are converted to the injection molding production, are still available on inquiry as special fittings made of pipe segments. No article numbers are defined for special fittings of any type.

Please note! Electrofusion sockets can not be processed directly with injection molded fittings. When using electrofusion sockets either segment welded special fittings must be used or pipe pieces must be welded to the injection molded fittings.

SDR	Art. no.	D [mm]	d1 [mm]	D1 [mm]	L [mm]	l [mm]	z [mm]	Weight [kg]	System	pipe segments	injection molded*	PU	Box unit	Price € m/pc
<i>branch: socket welding</i>														
7.4	13600	160	75	100,0	460,0	122,0	92,0	4,414	•	•			1	
	13602	160	90	120,0	460,0	125,0	92,0	4,515	•	•			1	
	13606	160	125	167,0	290,0	120,0	80,0	3,441	•		•		1	
	13608	200	75	100,0	500,0	142,0	112,0	7,110	•	•			1	
	13610	200	90	120,0	500,0	145,0	112,0	7,540	•	•			1	
	13612	200	110	147,0	500,0	149,0	112,0	7,325	•	•			1	
	13614	200	125	167,0	500,0	155,0	115,0	7,645	•	•			1	
	13624	250	75	100,0	750,0	167,0	137,0	16,600	•	•			1	
	13626	250	90	120,0	750,0	170,0	137,0	16,800	•	•			1	
	13628	250	110	147,0	750,0	174,0	137,0	16,800	•	•			1	
13630	250	125	167,0	750,0	180,0	140,0	17,000	•	•			1		
9	313600	160	75	100,0	460,0	122,0	92,0	3,903	•	•			1	
	313602	160	90	120,0	460,0	125,0	92,0	4,039	•	•			1	
	313608	200	75	100,0	500,0	142,0	112,0	6,476	•	•			1	
	313610	200	90	120,0	500,0	145,0	112,0	6,581	•	•			1	
	313612	200	110	147,0	500,0	149,0	112,0	6,863	•	•			1	
	313614	200	125	167,0	500,0	155,0	115,0	7,114	•	•			1	
	313624	250	75	100,0	750,0	167,0	137,0	14,802	•	•			1	
	313626	250	90	120,0	750,0	170,0	137,0	14,932	•	•			1	
	313628	250	110	147,0	750,0	174,0	137,0	15,178	•	•			1	
	313630	250	125	167,0	750,0	180,0	140,0	15,398	•	•			1	
313904	315	125	167,0	920,0	212,5	172,5	29,196	•	•			1		
313916	355	125	167,0	960,0	232,5	192,5	38,466	•	•			1		
11	13601	160	75	100,0	460,0	122,0	92,0	3,140	•	•			1	
	13603	160	90	120,0	460,0	125,0	92,0	3,176	•	•			1	
	13607	160	125	167,0	290,0	120,0	80,0	2,842	•		•		1	
	13609	200	75	100,0	500,0	142,0	112,0	5,284	•	•			1	
	13611	200	90	120,0	500,0	145,0	112,0	5,168	•	•			1	
	13613	200	110	147,0	500,0	149,0	112,0	5,648	•	•			1	
	13615	200	125	167,0	500,0	155,0	115,0	5,786	•	•			1	
	13625	250	75	100,0	750,0	167,0	137,0	12,000	•	•			1	
	13627	250	90	120,0	750,0	170,0	137,0	12,000	•	•			1	
	13629	250	110	147,0	750,0	174,0	137,0	13,000	•	•			1	
	13631	250	125	167,0	750,0	180,0	140,0	12,000	•	•			1	
	13651	315	125	167,0	920,0	213,0	173,0	25,150	•	•			1	
	13663	355	125	167,0	960,0	233,0	193,0	30,851	•	•			1	
	13676	400	125	167,0	1000,0	255,0	215,0	42,169	•	•			1	
13690	450	125	167,0	1050,0	280,0	240,0	55,794	•	•			1		

* status quo at the time of printing, further injection molded parts follow

RED.-T-PIECE, BUTT WELDING

Systems: **aquatherm green pipe**
 Standard: DIN 16962, DIN EN ISO 15874
 Branch: butt welding
 Form: see table

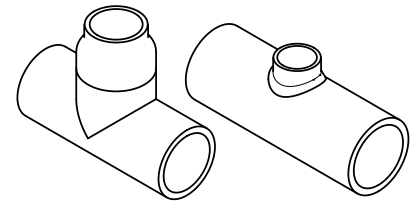
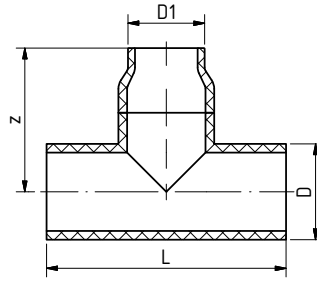

SDR	Art. no.	D [mm]	D1 [mm]	L [mm]	z [mm]	Weight [kg]	System	Pipe with reducer	Pipe with weld-in saddle	PU	Box unit	Price € m/pc
<i>branch: butt welding</i>												
7.4	13618	200	160	500,0	300,0	10,891	•	•		1		
	13634	250	160	750,0	375,0	28,000	•	•		1		
	13640	250	200	750,0	375,0	27,000	•	•		1		
9	313618	200	160	500,0	300,0	9,332	•	•		1		
	313634	250	160	750,0	375,0	21,547	•	•		1		
	313640	250	200	750,0	376,0	21,853	•	•		1		
	313906	315	160	920,0	238,0	29,237	•		•	1		
	313908	315	200	920,0	460,0	42,166	•	•		1		
	313910	315	250	920,0	460,0	42,557	•	•		1		
	313918	355	160	960,0	258,0	38,479	•		•	1		
	313920	355	200	960,0	268,0	39,237	•		•	1		
	313922	355	250	960,0	480,0	52,683	•	•		1		
	313924	355	315	960,0	480,0	55,511	•	•		1		
11	13619	200	160	500,0	300,0	7,445	•	•		1		
	13635	250	160	750,0	375,0	19,500	•	•		1		
	13641	250	200	750,0	375,0	18,500	•	•		1		
	13653	315	160	920,0	237,5	24,850	•		•	1		
	13655	315	200	920,0	460,0	29,400	•	•		1		
	13657	315	250	920,0	460,0	30,500	•	•		1		
	13665	355	160	960,0	257,5	30,893	•		•	1		
	13667	355	200	960,0	267,5	31,651	•		•	1		
	13669	355	250	960,0	480,0	39,220	•	•		1		
	13671	355	315	960,0	480,0	44,721	•	•		1		
	13678	400	160	1000,0	354,0	44,111	•		•	1		
	13680	400	200	1000,0	318,0	44,111	•		•	1		
	13682	400	250	1000,0	280,0	44,111	•		•	1		
	13684	400	315	1000,0	500,0	47,500	•	•		1		
	13685	400	355	1000,0	500,0	54,361	•	•		1		
	13692	450	160	1050,0	379,0	57,962	•		•	1		
	13694	450	200	1050,0	343,0	57,962	•		•	1		
	13696	450	250	1050,0	305,0	57,962	•		•	1		
13698	450	315	1050,0	315,0	58,818	•		•	1			
13699	450	355	1050,0	525,0	78,330	•	•		1			
13700	450	400	1050,0	525,0	78,330	•	•		1			

aquatherm blue pipe RED.-T-PIECE, SOCKET- & BUTT WELDING

Systems:	aquatherm blue pipe
Material:	Fusiolen® PP-R
Standard:	DIN 16962, DIN EN ISO 15874
Colour:	blue/green
Branch:	socket welding
Form:	pipes with weld-in saddle

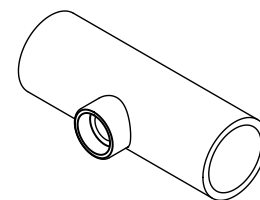
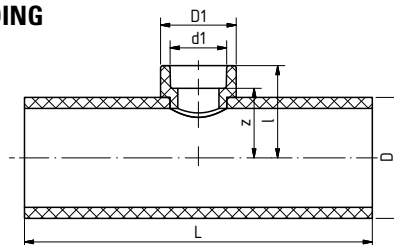

SDR	Art. no.	D [mm]	d1 [mm]	D1 [mm]	L [mm]	I [mm]	z [mm]	Weight [kg]	System	PU	Box unit	Price € m/pc
<i>branch: socket welding</i>												
	2013609	200	75	100,0	500,0	142,0	112,0	5,460	•	1		
	2013611	200	90	120,0	500,0	145,0	112,0	5,580	•	1		
	2013613	200	110	147,0	500,0	149,0	112,0	5,810	•	1		
	2013615	200	125	167,0	500,0	155,0	115,0	6,100	•	1		
	2013625	250	75	100,0	750,0	167,0	137,0	12,440	•	1		
11	2013627	250	90	120,0	750,0	170,0	137,0	12,420	•	1		
	2013629	250	110	147,0	750,0	174,0	137,0	12,760	•	1		
	2013631	250	125	167,0	750,0	180,0	140,0	13,030	•	1		
	2013651	315	125	167,0	920,0	213,0	173,0	25,000	•	1		
	2013663	355	125	167,0	960,0	233,0	193,0	32,500	•	1		
	2013676	400	125	167,0	1000,0	255,0	215,0	42,100	•	1		
	2013690	450	125	167,0	1050,0	280,0	240,0	55,700	•	1		

aquatherm blue pipe RED.-T-PIECE, BUTT WELDING

Systems:	aquatherm blue pipe
Material:	Fusiolen® PP-R
Standard:	DIN 16962, DIN EN ISO 15874
Colour:	blue/green
Branch:	butt welding

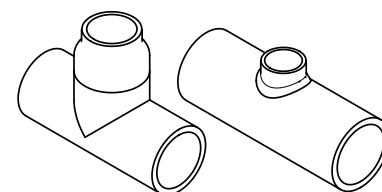
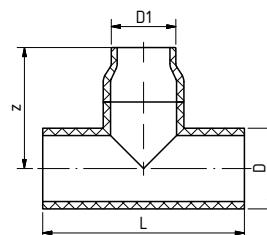

SDR	Art. no.	D [mm]	D1 [mm]	L [mm]	z [mm]	Weight [kg]	System	Pipe with reducer	Pipe with weld-in saddle	PU	Box unit	Price € m/pc
<i>branch: butt welding</i>												
	2013619	200	160	500,0	300,0	7,650	•	•		1		
	2013635	250	160	750,0	375,0	19,030	•	•		1		
	2013641	250	200	750,0	375,0	21,100	•	•		1		
	2013653	315	160	920,0	237,5	25,000	•		•	1		
	2013655	315	200	920,0	460,0	33,200	•	•		1		
	2013657	315	250	920,0	460,0	31,500	•	•		1		
	2013665	355	160	960,0	257,5	32,500	•		•	1		
	2013667	355	200	960,0	267,5	30,200	•		•	1		
	2013669	355	250	960,0	480,0	40,000	•	•		1		
	2013671	355	315	960,0	480,0	40,000	•	•		1		
11	2013678	400	160	1000,0	354,0	44,100	•		•	1		
	2013680	400	200	1000,0	318,0	44,100	•		•	1		
	2013682	400	250	1000,0	280,0	46,000	•		•	1		
	2013684	400	315	1000,0	500,0	57,790	•	•		1		
	2013685	400	355	1000,0	500,0	52,715	•	•		1		
	2013692	450	160	1050,0	379,0	57,900	•		•	1		
	2013694	450	200	1050,0	343,0	57,900	•		•	1		
	2013696	450	250	1050,0	305,0	57,900	•		•	1		
	2013698	450	315	1050,0	315,0	58,400	•		•	1		
	2013699	450	355	1050,0	525,0	62,491	•	•		1		
	2013700	450	400	1050,0	525,0	62,683	•	•		1		

aquatherm blue pipe RED.-T-PIECE SOCKET- & BUTT WELDING

Systems: aquatherm blue pipe
Material: Fusiolen® PP-R
Standard: DIN 16962, DIN EN ISO 15874
Colour: blue/green
Branch: socket welding
Form: pipes with weld-in saddle

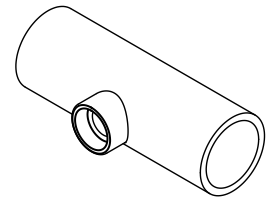
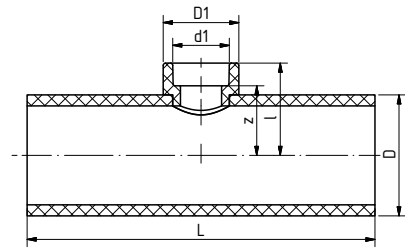

SDR	Art. no.	D [mm]	d1 [mm]	D1 [mm]	L [mm]	l [mm]	z [mm]	Weight [kg]	System	pipe segments	injection molded*	PU	Box unit	Price € m/pc
<i>branch: socket welding</i>														
17.6	2513600	160	75	100,0	460,0	122,0	92,0	2,227	•	•		1		
	2513602	160	90	120,0	460,0	125,0	92,0	2,364	•	•		1		
	2513606	160	125	167,0	290,0	120,0	80,0	2,309			•	1		
	2513608	200	75	100,0	500,0	142,0	112,0	3,620	•	•		1		
	2513610	200	90	120,0	500,0	145,0	112,0	3,742	•	•		1		
	2513612	200	110	147,0	500,0	149,0	112,0	3,976	•	•		1		
	2513614	200	125	167,0	500,0	155,0	115,0	4,269	•	•		1		
	2513624	250	75	100,0	750,0	167,0	137,0	8,149	•	•		1		
	2513626	250	90	120,0	750,0	170,0	137,0	8,274	•	•		1		
	2513628	250	110	147,0	750,0	174,0	137,0	8,504	•	•		1		
	2513630	250	125	167,0	750,0	180,0	140,0	9,000	•	•		1		
	2513651	315	125	167,0	920,0	213,0	173,0	17,570	•	•		1		
	2513663	355	125	167,0	960,0	233,0	193,0	21,500	•	•		1		
	2513676	400	125	167,0	1000,0	255,0	215,0	27,690	•	•		1		
	2513690	450	125	167,0	1050,0	280,0	240,0	36,470	•	•		1		
2513804	500	125	167,0	1200,0	305,0	265,0	51,250	•	•		1			
2513821	560	125	167,0	1260,0	335,0	295,0	66,900	•	•		1			
2513839	630	125	167,0	1330,0	370,0	330,0	89,170	•	•		1			

* status quo at the time of printing, further injection molded parts follow

aquatherm blue pipe RED.-T-PIECE, BUTT WELDING

Systems: aquatherm blue pipe
Standard: DIN 16962, DIN EN ISO 15874
Colour: blue/green
Branch: butt welding
Form: see table

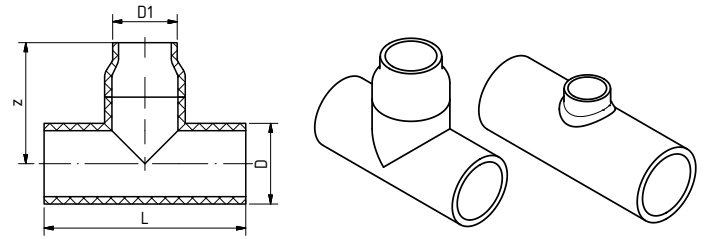

SDR	Art. no.	D [mm]	D1 [mm]	L [mm]	z [mm]	Weight [kg]	System	Pipe with reducer	Pipe with weld-in saddle	PU	Box unit	Price € m/pc
<i>butt welding</i>												
	2513618	200	160	500,0	250,0	5,000	•	•			1	
	2513634	250	160	750,0	375,0	11,600	•	•			1	
	2513640	250	200	750,0	375,0	11,500	•	•			1	
	2513653	315	160	920,0	237,5	16,500	•		•		1	
	2513655	315	200	920,0	460,0	23,600	•	•			1	
	2513657	315	250	920,0	460,0	22,600	•	•			1	
	2513665	355	160	960,0	257,5	21,500	•		•		1	
	2513667	355	200	960,0	267,5	21,900	•		•		1	
	2513669	355	250	960,0	480,0	28,300	•	•			1	
	2513671	355	315	960,0	480,0	30,500	•	•			1	
	2513678	400	160	1000,0	354,0	29,700	•		•		1	
	2513680	400	200	1000,0	318,0	29,700	•		•		1	
	2513682	400	250	1000,0	280,0	29,000	•		•		1	
	2513684	400	315	1000,0	500,0	30,667	•	•			1	
	2513685	400	355	1000,0	500,0	30,748	•	•			1	
	2513692	450	160	1050,0	379,0	37,000	•		•		1	
	2513694	450	200	1050,0	343,0	37,000	•		•		1	
	2513696	450	250	1050,0	305,0	37,000	•		•		1	
	2513698	450	315	1050,0	315,0	37,000	•		•		1	
	2513699	450	355	1050,0	525,0	50,500	•	•			1	
	2513700	450	400	1050,0	525,0	50,100	•	•			1	
17.6	2513806	500	160	1200,0	404,0	53,400	•		•		1	
	2513808	500	200	1200,0	368,0	53,500	•		•		1	
	2513810	500	250	1200,0	330,0	53,500	•		•		1	
	2513812	500	315	1200,0	340,0	54,000	•		•		1	
	2513813	500	355	1200,0	600,0	57,039	•	•			1	
	2513814	500	400	1200,0	600,0	57,245	•	•			1	
	2513815	500	450	1200,0	600,0	57,365	•	•			1	
	2513823	560	160	1260,0	434,0	69,000	•		•		1	
	2513825	560	200	1260,0	398,0	69,000	•		•		1	
	2513827	560	250	1260,0	360,0	69,000	•		•		1	
	2513829	560	315	1260,0	370,0	66,700	•		•		1	
	2513831	560	400	1260,0	630,0	74,021	•	•			1	
	2513832	560	450	1260,0	630,0	74,249	•	•			1	
	2513833	560	500	1260,0	630,0	74,381	•	•			1	
	2513841	630	160	1330,0	474,0	91,530	•		•		1	
	2513843	630	200	1330,0	438,0	91,500	•		•		1	
	2513845	630	250	1330,0	400,0	91,500	•		•		1	
	2513847	630	315	1330,0	405,0	92,350	•		•		1	
	2513849	630	400	1330,0	665,0	97,299	•	•			1	
	2513850	630	450	1330,0	665,0	97,703	•	•			1	
	2513851	630	500	1330,0	665,0	98,032	•	•			1	
	2513852	630	560	1330,0	665,0	93,967	•	•			1	

CROSS

Systems: aquatherm green pipe,
aquatherm blue pipe,
aquatherm lilac pipe

Material: Fusiolen® PP-R

Standard: DIN 16962, DIN EN ISO 15874

Colour: green

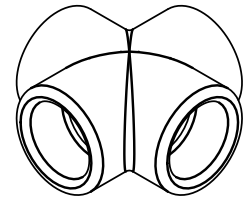
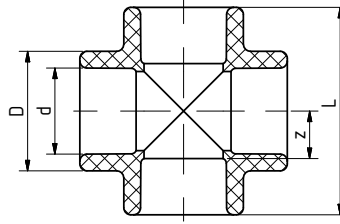

SDR	Art. no.	Dimension d [mm]	D [mm]	L [mm]	z [mm]	Weight [kg]	System	PU	Box unit	Price € m/pc
<i>socket welding</i>										
6	13708	20	29,5	51,5	11,3	0,025	• • •	10		
7.4	13710	25	34,0	59,0	13,5	0,035	• • •	10		
9	13712	32	43,0	70,0	17,0	0,062	• • •	5		
11	13714	40	52,0	83,0	21,0	0,099	• • •	5		

CROSS OVER FITTING

Systems: aquatherm green pipe,
aquatherm blue pipe,
aquatherm lilac pipe

Material: Fusiolen® PP-R

Standard: DIN 16962, DIN EN ISO 15874

Colour: green

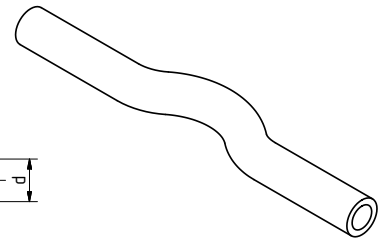
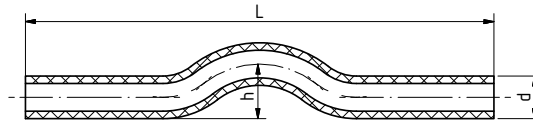

SDR	Art. no.	Dimension d [mm]	h [mm]	L [mm]	Weight [kg]	System	PU	Box unit	Price € m/pc
<i>socket welding</i>									
6	16106	16	17,0	352,0	0,038	•	10		
7.4	16108	20	22,0	352,0	0,060	• • •	10		
9	16110	25	25,0	352,0	0,091	• • •	10		
11	16112	32	32,0	352,0	0,154	• • •	5		

END CAP

Systems: aquatherm green pipe,
aquatherm blue pipe,
aquatherm lilac pipe

Material: Fusiolen® PP-R & PP-RP

Standard: DIN 16962, DIN EN ISO 15874

Colour: green

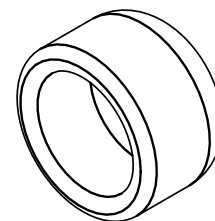
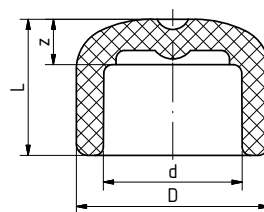

SDR	Art. no.	Dimension d [mm]	D [mm]	z [mm]	L [mm]	Weight [kg]	System	PU	Box unit	Price € m/pc
<i>socket welding</i>										
6 7.4 9 11	14106	16	26,0	13,5	26,5	0,008	•	10	2000	
	14108	20	29,5	9,5	24,0	0,009	• • •	10	2000	
	14110	25	34,0	8,0	24,0	0,011	• • •	10	1500	
	14112	32	43,0	11,0	29,0	0,023	• • •	5	1000	
	14114	40	52,0	17,5	38,0	0,042	• • •	5	500	
	14116	50	68,0	21,0	44,5	0,082	• • •	5	300	
	14118	63	84,0	24,5	52,0	0,146	• • •	1	150	
	14120	75	100,0	28,5	58,5	0,243	• • •	1	90	
	14122	90	120,0	34,5	67,5	0,365	• • •	1	60	
	14124	110	147,0	28,0	65,0	0,635	• • •	1	40	
	14126	125	167,0	42,0	82,0	0,872	• • •	1		

END CAP BUTT-WELDING

Systems: aquatherm green pipe,
aquatherm blue pipe,
aquatherm lilac pipe

Material: Fusiolen® PP-R & PP-RP

Standard: DIN 16962, DIN EN ISO 15874

Colour: green

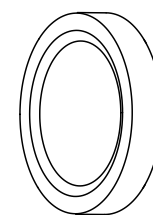
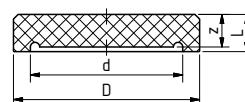

SDR	Art. no.	Dimension D [mm]	L [mm]	z [mm]	d [mm]	Weight [kg]	System	PU	Box unit	Price € m/pc
7.4	14130	160	70,0	21,9	116,2	0,876	•	1		
	14134	200	80,0	27,4	145,2	1,398	•	1		
	14138	250	90,0	34,2	181,6	2,530	•	1		
9	314130	160	70,0	17,9	124,2	0,847	•	1		
	314134	200	80,0	22,4	155,2	1,373	•	1		
	314138	250	90,0	27,9	194,2	2,856	•	1		
	314142	315	70,0	52,5	244,6	5,080	•	1		
	314144	355	80,0	66,5	275,6	7,050	•	1		
11	14131	160	70,0	14,6	130,8	0,759	• •	1		
	14135	200	80,0	18,2	163,6	1,070	• •	1		
	14139	250	90,0	22,7	204,6	1,989	• •	1		
	14143	315	70,0	52,5	257,8	4,200	• •	1		
	14145	355	80,0	67,5	290,6	6,410	• •	1		
	14147	400	70,0	60,0	327,4	7,190	• •	1		
	14149	450	80,0	70,0	368,2	10,500	• •	1		
17.6	2514130	160	70,0	9,1	141,8	0,679	•	1		
	2514134	200	80,0	11,4	177,2	0,925	•	1		
	2514138	250	90,0	14,2	221,6	2,109	•	1		
	2514142	315	70,0	60,0	279,2	4,500	•	1		
	2514144	355	70,0	60,0	314,8	5,540	•	1		
	2514146	400	75,0	65,0	354,6	6,000	•	1		
	2514148	450	70,0	56,0	399,0	8,520	•	1		
	2514150	500	75,0	62,0	443,2	12,500	•	1		
	2514152	560	80,0	69,5	496,6	16,000	•	1		
	2514154	630	90,0	78,0	558,6	23,500	•	1		

WELD-IN SADDLE

for pressureless installation

Systems:

aquatherm green pipe,
aquatherm blue pipe,
aquatherm lilac pipe

Material:

Fusiolen® PP-R

Standard:

DIN 16962, DIN EN ISO 15874

Colour:

green

Notice

*do not use with aquatherm blue pipe OT

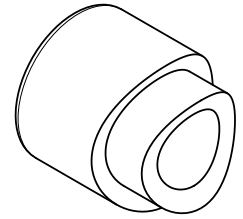
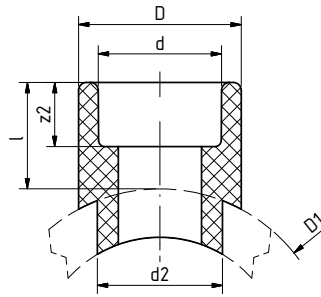

SDR	Art. no.	D1 [mm]	d [mm]	d2 [mm]	l [mm]	z2 [mm]	D [mm]	Weight [kg]	System	PU	Box unit	Price € m/pc
<i>socket welding</i>												
	15156*	40	20	25	27,0	14,5	29,5	0,016	• • •	5		
	15158*	40	25	25	28,5	16,0	34,0	0,017	• • •	5		
	15160	50	20	25	27,5	14,5	29,5	0,018	• • •	5		
	15162	50	25	25	28,5	16,0	34,0	0,019	• • •	5		
	15164	63	20	25	27,5	14,5	29,5	0,017	• • •	5		
	15166	63	25	25	28,5	16,0	34,0	0,019	• • •	5		
	15168	63	32	32	30,0	18,0	43,0	0,028	• • •	5		
	15170	75	20	25	27,5	14,5	29,5	0,018	• • •	5		
	15172	75	25	25	28,5	16,0	34,0	0,019	• • •	5		
	15174	75	32	32	30,0	18,0	43,0	0,028	• • •	5		
	15175	75	40	40	34,0	20,5	52,0	0,049	• • •	5		
	15176	90	20	25	27,5	14,5	29,5	0,018	• • •	5		
	15178	90	25	25	28,5	16,0	34,0	0,019	• • •	5		
	15180	90	32	32	30,0	18,0	43,0	0,029	• • •	5		
	15181	90	40	40	34,0	20,5	52,0	0,048	• • •	5		
	15182	110	20	25	27,5	14,5	29,5	0,019	• • •	5		
	15184	110	25	25	28,5	16,0	34,0	0,020	• • •	5		
	15186	110	32	32	30,0	18,0	43,0	0,030	• • •	5		
	15188	110	40	40	34,0	20,5	52,0	0,050	• • •	5		
	15189	110	50	50	34,0	23,5	68,0	0,091	• • •	5		
	15190	125	20	25	27,5	14,5	29,5	0,019	• • •	5		
	15192	125	25	25	28,5	16,0	34,0	0,020	• • •	5		
	15194	125	32	32	30,0	18,0	43,0	0,029	• • •	5		
	15196	125	40	40	34,0	20,5	52,0	0,050	• • •	5		
6	15197	125	50	50	34,0	23,5	68,0	0,090	• • •	5		
7.4	15198	125	63	63	38,0	27,5	84,0	0,149	• • •	5		
9	15206	160	20	25	27,5	14,5	29,5	0,021	• • •	5		
11	15208	160	25	25	28,5	16,0	34,0	0,023	• • •	5		
17.6	15210	160	32	32	30,0	18,0	43,0	0,034	• • •	5		
	15212	160	40	40	34,0	20,5	52,0	0,054	• • •	5		
	15214	160	50	50	34,0	23,5	68,0	0,094	• • •	5		
	15216	160	63	63	38,0	27,5	84,0	0,157	• • •	5		
	15218	160	75	75	42,0	30,0	100,0	0,238	• • •	5		
	15220	160	90	90	45,0	33,0	120,0	0,360	• • •	5		
	15228	200-250	20	25	27,5	14,5	29,5	0,020	• • •	5		
	15229	200-250	25	25	28,5	16,0	34,0	0,021	• • •	5		
	15230	200-250	32	32	30,0	18,0	43,0	0,031	• • •	5		
	15231	200	40	40	34,0	20,5	52,0	0,049	• • •	5		
	15232	200	50	50	34,0	23,5	68,0	0,087	• • •	5		
	15233	200	63	63	37,5	27,5	84,0	0,146	• • •	5		
	15234	200	75	75	42,0	30,0	100,0	0,225	• • •	5		
	15235	200	90	90	45,0	33,0	120,0	0,356	• • •	5		
	15236	200	110	110	49,0	37,0	147,0	0,638	• • •	5		
	15237	200	125	125	55,0	40,0	167,0	0,862	• • •	5		
	15251	250	40	40	34,0	20,5	52,0	0,053	• • •	5		
	15252	250	50	50	34,0	23,5	68,0	0,090	• • •	5		
	15253	250	63	63	37,5	27,5	84,0	0,152	• • •	5		
	15254	250	75	75	42,0	30,0	100,0	0,222	• • •	5		
	15255	250	90	90	45,0	33,0	120,0	0,348	• • •	5		
	15256	250	110	110	49,0	37,0	147,0	0,602	• • •	5		
	15257	250	125	125	55,0	40,0	167,0	0,820	• • •	5		

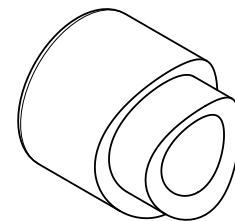
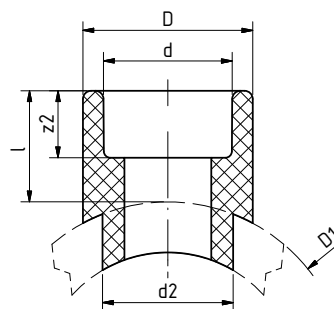
WELD-IN SADDLE*for pressureless installation***Systems:** aquatherm green pipe,
aquatherm blue pipe**Material:** Fusiolen® PP-R**Standard:** DIN 16962, DIN EN ISO 15874**Colour:** green

SDR	Art. no.	D1 [mm]	d [mm]	d2 [mm]	l [mm]	z2 [mm]	D [mm]	Weight [kg]	System	PU	Box unit	Price € m/pc
<i>socket welding</i>												
6 7.4 9 11 17.6	15260	315-355	63	63	37,5	27,5	84,0	0,153	• •	1		
	15261	315-355	75	75	42,0	30,0	100,0	0,230	• •	1		
	15262	315	90	90	45,0	33,0	120,0	0,363	• •	1		
	15263	315	110	110	49,0	37,0	147,0	0,592	• •	1		
	15264	315	125	125	55,0	40,0	167,0	0,830	• •	1		
	15268	355	90	90	45,0	33,0	120,0	0,355	• •	1		
	15269	355	110	110	49,0	37,0	147,0	0,586	• •	1		
	15270	355	125	125	55,0	40,0	167,0	0,813	• •	1		
	15275	400-500	75	75	42,0	30,0	100,0	0,216	• •	1		
	15277	400-450	110	110	49,0	37,0	147,0	0,535	• •	1		
	15278	400	125	125	55,0	40,0	167,0	0,693	• •	1		
	15288	400-500	90	90	45,0	33,0	120,0	0,330	• •	1		
	15290	450-500	125	125	55,0	40,0	167,0	0,671	• •	1		
	15300	400-630	63	63	37,5	27,5	84,0	0,498	• •	1		
	15303	500-560	110	110	49,0	37,5	147,0	0,533	• •	1		
	15315	560-630	75	75	42,0	30,0	100,0	0,260	• •	1		
	15316	560-630	90	90	45,0	33,0	120,0	0,350	• •	1		
	15318	560-630	125	125	55,0	40,0	167,0	0,689	• •	1		
15331	630	110	110	49,0	37,0	147,0	0,567	• •	1			

With weld-on surface and additional weld-in socket for the fusion with the inner pipe wall.

The necessary tools for the fusion of aquatherm green pipe weld-in saddles are listed from page 180 onwards.

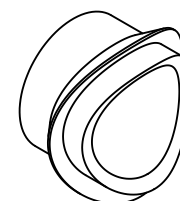
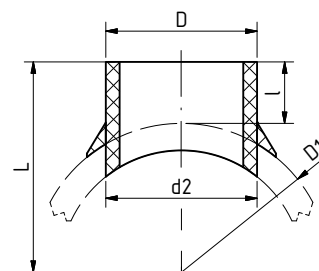
WELD-IN SADDLE BUTT WELDING*for pressureless installation***Systems:** aquatherm green pipe,
aquatherm blue pipe**Material:** Fusiolen® PP-R & PP-RP**Standard:** DIN 16962, DIN EN ISO 15874**Colour:** green

SDR	Art. no.	D1 [mm]	D [mm]	d2 [mm]	l [mm]	L [mm]	Weight [kg]	System	PU	Box unit	Price € m/pc
<i>butt welding</i>											
9	315265	315	160	160	80,0	237,5	0,831	• •	1		
	315271	355	160	160	80,0	257,5	0,845	• •	1		
11	15265	315	160	160	80,0	237,5	0,868	• •	1		
	15271	355	160	160	80,0	257,5	0,867	• •	1		

With weld-on surface and additional weld-in socket for the fusion with the inner pipe wall.

The necessary tools for the fusion of aquatherm green pipe weld-in saddles are listed from page 180 onwards.

WELD-IN SADDLE WITH FEMALE THREAD

for pressureless installation

Systems: aquatherm green pipe,
aquatherm blue pipe,
aquatherm lilac pipe

Material: Fusiolen® PP-R

Standard: DIN 16962, DIN EN ISO 15874
Fusiolen® PP-R, brass

Colour: green

Notice *do not use with aquatherm blue pipe OT

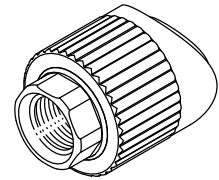
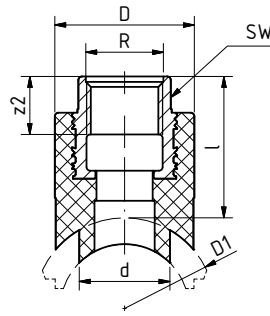

SDR	Art. no.	D1 [mm]	d [mm]	l [mm]	z2 [mm]	D [mm]	R	SW [mm]	Weight [kg]	System	PU	Box unit	Price € m/pc
<i>socket welding</i>													
	28214*	40	25	39,0	16,0	38,5	1/2"	24	0,088	• • •	5		
	28216	50	25	39,0	16,0	38,5	1/2"	24	0,090	• • •	5		
	28218	63	25	39,0	16,0	38,5	1/2"	24	0,089	• • •	5		
	28220	75	25	39,0	16,0	38,5	1/2"	24	0,083	• • •	5		
	28222	90	25	39,0	16,0	38,5	1/2"	24	0,090	• • •	5		
	28224	110	25	39,0	16,0	38,5	1/2"	24	0,089	• • •	5		
	28226	125	25	39,0	16,0	38,0	1/2"	24	0,092	• • •	5		
	28230	160	25	39,0	16,0	38,5	1/2"	24	0,092	• • •	5		
	28232	200-250	25	39,0	16,0	38,5	1/2"	24	0,092	• • •	5		
	28234	40	25	39,0	21,0	43,5	3/4"	31	0,107	• • •	5		
6	28236	50	25	39,0	21,0	43,5	3/4"	31	0,110	• • •	5		
7.4	28238	63	25	39,0	21,0	43,5	3/4"	31	0,109	• • •	5		
9	28240	75	25	39,0	21,0	43,5	3/4"	31	0,109	• • •	5		
11	28242	90	25	39,0	21,0	43,5	3/4"	31	0,110	• • •	5		
17.6	28244	110	25	39,0	21,0	43,5	3/4"	31	0,110	• • •	5		
	28246	125	25	39,0	21,0	43,5	3/4"	31	0,112	• • •	5		
	28250	160	25	39,0	21,0	43,5	3/4"	31	0,112	• • •	5		
	28254	200-250	25	39,0	21,0	43,5	3/4"	31	0,112	• • •	5		
	28260	75	32	43,0	22,0	60,0	1"	39	0,223	• • •	5		
	28262	90	32	43,0	22,0	60,0	1"	39	0,223	• • •	5		
	28264	110	32	43,0	22,0	60,0	1"	39	0,223	• • •	5		
	28266	125	32	43,0	22,0	60,0	1"	39	0,224	• • •	5		
	28270	160	32	43,0	22,0	60,0	1"	39	0,226	• • •	5		
	28274	200-250	32	43,0	22,0	60,0	1"	39	0,244	• • •	5		

WELD-IN SADDLE WITH FEMALE THREAD

for pressureless installation

Systems: aquatherm green pipe,
aquatherm blue pipe,
aquatherm lilac pipe

Material: Fusiolen® PP-R

Standard: DIN 16962, DIN EN ISO 15874
Fusiolen® PP-R, stainless steel

Colour: green

Notice *do not use with aquatherm blue pipe OT

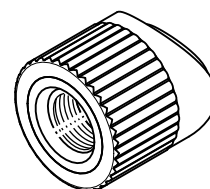
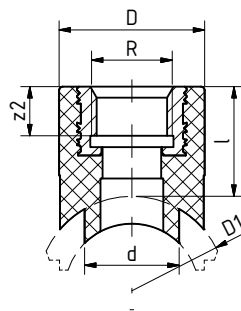

SDR	Art. no.	D1 [mm]	d [mm]	l [mm]	z2 [mm]	D [mm]	R	Weight [kg]	System	PU	Box unit	Price € m/pc
<i>socket welding</i>												
	928214*	40	25	39,0	16,0	38,5	1/2"	0,062	• • •		5	
	928216	50	25	39,0	16,0	38,5	1/2"	0,064	• • •		5	
	928218	63	25	39,0	16,0	38,5	1/2"	0,064	• • •		5	
	928220	75	25	39,0	16,0	38,5	1/2"	0,064	• • •		5	
	928222	90	25	39,0	16,0	38,5	1/2"	0,064	• • •		5	
	928224	110	25	39,0	16,0	38,5	1/2"	0,069	• • •		5	
	928226	125	25	39,0	16,0	38,5	1/2"	0,065	• • •		5	
6	928230	160	25	39,0	16,0	38,5	1/2"	0,066	• • •		5	
7.4	928232	200-250	25	39,0	16,0	38,5	1/2"	0,065	• • •		5	
9	928234	40	25	39,0	21,0	43,5	3/4"	0,082	• • •		5	
11	928236	50	25	39,0	21,0	43,5	3/4"	0,074	• • •		5	
17.6	928238	63	25	39,0	21,0	43,5	3/4"	0,073	• • •		5	
	928240	75	25	39,0	21,0	43,5	3/4"	0,074	• • •		5	
	928242	90	25	39,0	21,0	43,5	3/4"	0,074	• • •		5	
	928244	110	25	39,0	21,0	43,5	3/4"	0,083	• • •		5	
	928246	125	25	39,0	21,0	43,5	3/4"	0,074	• • •		5	
	928250	160	25	39,0	21,0	43,5	3/4"	0,076	• • •		5	
	928254	200-250	25	39,0	21,0	43,5	3/4"	0,084	• • •		5	

WELD-IN SADDLE WITH FEMALE THREAD

for pressureless installation

Systems: aquatherm green pipe,
aquatherm blue pipe,
aquatherm lilac pipe

Material: Fusiolen® PP-R

Standard: DIN 16962, DIN EN ISO 15874
Fusiolen® PP-R, stainless steel

Colour: green

Notice *do not use with aquatherm blue pipe OT

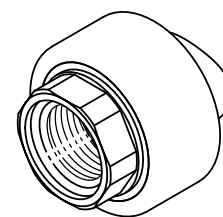
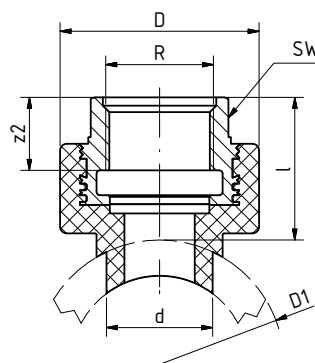

SDR	Art. no.	D1 [mm]	d [mm]	l [mm]	z2 [mm]	D [mm]	R	SW [mm]	Weight [kg]	System	PU	Box unit	Price € m/pc
<i>socket welding</i>													
	928260	75	32	43,0	22,0	60,0	1"	39	0,234	• • •		5	
6	928262	90	32	43,0	22,0	60,0	1"	39	0,235	• • •		5	
7.4	928264	110	32	43,0	22,0	60,0	1"	39	0,236	• • •		5	
9	928266	125	32	43,0	22,0	60,0	1"	39	0,235	• • •		5	
11	928270	160	32	43,0	22,0	60,0	1"	39	0,238	• • •		5	
17.6	928274	200-250	32	43,0	22,0	60,0	1"	39	0,237	• • •		5	

WELD-IN SADDLE WITH MALE THREAD

for pressureless installation

Systems: aquatherm green pipe,
aquatherm blue pipe,
aquatherm lilac pipe

Material: Fusiolen® PP-R

Standard: DIN 16962, DIN EN ISO 15874

Colour: green

Notice *do not use with aquatherm blue pipe OT

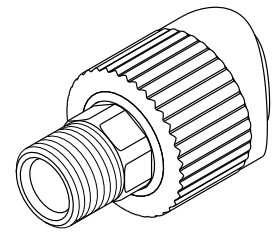
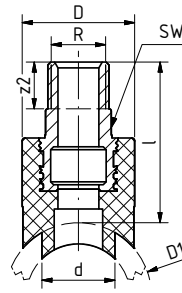

SDR	Art. no.	D1 [mm]	d [mm]	l [mm]	z2 [mm]	D [mm]	R	SW [mm]	Weight [kg]	System	PU	Box unit	Price € m/pc
<i>socket welding</i>													
6 7.4 9 11 17.6	28314*	40	25	55,0	16,0	38,5	1/2"	21	0,088	• • •	5		
	28316	50	25	55,0	16,0	38,5	1/2"	21	0,090	• • •	5		
	28318	63	25	55,0	16,0	38,5	1/2"	21	0,089	• • •	5		
	28320	75	25	55,0	16,0	38,5	1/2"	21	0,097	• • •	5		
	28322	90	25	55,0	16,0	38,5	1/2"	21	0,090	• • •	5		
	28324	110	25	55,0	16,0	38,5	1/2"	21	0,089	• • •	5		
	28326	125	25	55,0	16,0	38,5	1/2"	21	0,092	• • •	5		
	28330	160	25	55,0	16,0	38,5	1/2"	21	0,092	• • •	5		
	28334*	40	25	56,0	17,0	43,5	3/4"	24	0,107	• • •	5		
	28336	50	25	56,0	17,0	43,5	3/4"	24	0,110	• • •	5		
	28338	63	25	56,0	17,0	43,5	3/4"	24	0,109	• • •	5		
	28340	75	25	56,0	17,0	43,5	3/4"	24	0,109	• • •	5		
	28342	90	25	56,0	17,0	43,5	3/4"	24	0,110	• • •	5		
	28344	110	25	56,0	17,0	43,5	3/4"	24	0,110	• • •	5		
	28346	125	25	56,0	17,0	43,5	3/4"	24	0,112	• • •	5		
	28350	160	25	56,0	17,0	43,5	3/4"	24	0,112	• • •	5		

With hex shaped male thread, weld-in surface and weld-in socket for fusion with the inner wall of the pipe. The necessary tools for the fusion of aquatherm green pipe weld-in saddles are listed from page 180 onwards.

aquatherm WELD-ON SADDLE SET WITH BALL VALVE

for installation under pressure

in use with tapping tool page 184

Systems: aquatherm green pipe,
aquatherm blue pipe,
aquatherm lilac pipe

Material: Fusiolen® PP-R

Standard: DIN 16962, DIN EN ISO 15874

Colour: green

Notice do not use with aquatherm blue pipe OT

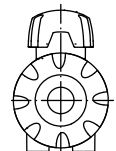
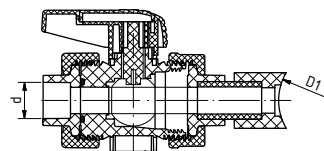
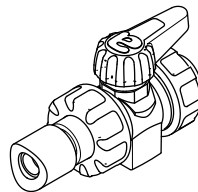

SDR	Art. no.	d [mm]	D1 [mm]	System	PU	Box unit	Price € m/pc
6 7.4 9 11 17.6	16175	40	75	• • •	1		
	16181	40	90	• • •	1		
	16188	40	110	• • •	1		
	16196	40	125	• • •	1		
	16198	63	125	• • •	1		
	16212	40	160	• • •	1		
	16216	63	160	• • •	1		
	16231	40	200	• • •	1		
	16233	63	200	• • •	1		
	16251	40	250	• • •	1		
	16253	63	250	• • •	1		
	16260	63	315-355	• • •	1		
	16300	63	400-630	• • •	1		

The required tools for the fusion of aquatherm green pipe weld-on saddles are listed from page 185 onwards.

FLANGE ADAPTER SOCKET WELDING

with gasket

Systems: aquatherm green pipe,
aquatherm blue pipe,
aquatherm lilac pipe

Material: Fusiolen® PP-R

Standard: DIN 16962, DIN EN ISO 15874

Colour: green

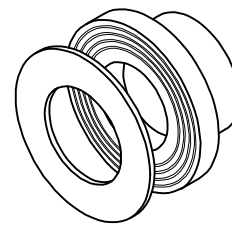
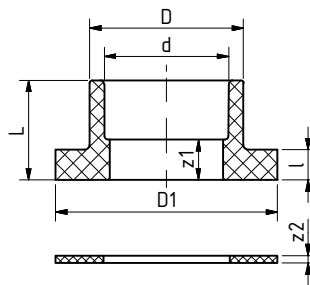

SDR	Art. no.	Dimension d [mm]	L [mm]	l [mm]	D [mm]	D1 [mm]	z1 [mm]	z2 [mm]	Weight [kg]	System	PU	Box unit	Price € m/pc
<i>socket welding</i>													
6 7.4 9 11	15512	32	34,0	10,0	41,0	68,0	16,0	3	0,053	• • •	1		
	15514	40	35,5	11,0	50,0	78,0	15,0	3	0,071	• • •	1		
	15516	50	39,5	12,0	61,0	88,0	16,0	3	0,071	• • •	1		
	15518	63	43,5	14,0	76,0	102,0	16,0	3	0,112	• • •	1		
	15520	75	46,0	16,0	90,0	122,0	16,0	3	0,169	• • •	1		
	15522	90	50,0	17,0	108,0	138,0	17,0	3	0,261	• • •	1		
	15524	110	55,5	18,5	131,0	158,0	18,5	3	0,329	• • •	1		
	15527	125	63,0	20,0	165,0	188,0	23,0	3	0,724	• • •	1		

FLANGE ADAPTER SOCKET WELDING

with gasket

Systems: aquatherm green pipe,
aquatherm blue pipe,
aquatherm lilac pipe

Material: Fusiolen® PP-R

Standard: DIN 16962, DIN EN ISO 15874

Colour: green

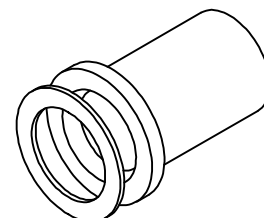
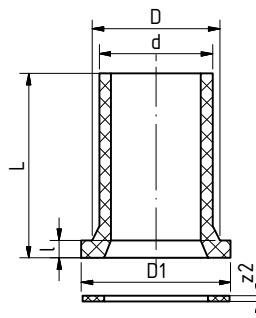

SDR	Art. no.	Dimension d [mm]	L [mm]	l [mm]	D [mm]	D1 [mm]	z2 [mm]	Weight [kg]	System	PU	Box unit	Price € m/pc
6 7.4 9 11	15526	125	195,0	18,5	131,0	158,0	3	1,180	• • •	1		

*Only use with fitting 125 mm; with 110 mm flange adapter suitable for Art. no. 15724

Suitable flange adapter for shut-off valves are available on request.

FLANGE ADAPTER BUTT WELDING

with gasket

Systems: aquatherm green pipe,
aquatherm blue pipe

Material: Fusiolen® PP-R & PP-RP

Standard: DIN 16962, DIN EN ISO 15874

Colour: green

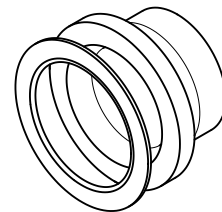
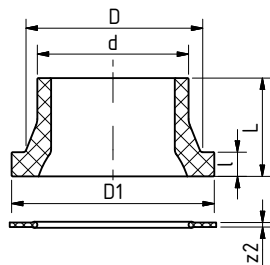

SDR	Art. no.	Dimension d [mm]	L [mm]	l [mm]	D [mm]	D1 [mm]	z2 [mm]	Weight [kg]	System	PU	Box unit	Price € m/pc	
<i>butt welding</i>													
9	15530	160	93,0	25,0	175,0	212,0	3,00	1,163	•	1			
	15534	200	130,0	32,0	232,0	268,0	6,00	2,292	•	1			
	15538	250	130,0	35,0	285,0	320,0	6,00	3,298	•	1			
	315530*	160	93,0	25,0	175,0	212,0	3	1,150	•	1			
	315534	200	130,0	32,0	232,0	268,0	6	2,292	•	1			
	315538	250	130,0	35,0	285,0	320,0	6	3,313	•	1			
	315542	315	172,5	52,0	337,0	370,0	6	5,640	•	1			
	315544	355	217,0	77,0	372,0	432,0	6	14,000	•	1			
	11	15531	160	93,0	25,0	175,0	212,0	3	0,955	• •	1		
		15535	200	130,0	32,0	232,0	268,0	6	1,957	• •	1		
15539		250	130,0	35,0	285,0	320,0	6	2,717	• •	1			
15543		315	168,0	35,0	335,0	370,0	6	6,000	• •	1			
15545		355	180,0	40,0	373,0	430,0	6	7,930	• •	1			
15547		400	195,0	46,0	427,0	482,0	6	12,000	• •	1			
15549		450	139,0	60,0	514,0	585,0	7	14,540	• •	1			
17.6	2515530	160	80,0	18,0	175,0	212,0	3	0,821	•	1			
	2515534	200	130,0	32,0	232,0	268,0	6	1,849	•	1			
	2515538	250	130,0	35,0	285,0	320,0	6	2,736	•	1			
	2515542	315	168,0	25,0	335,0	370,0	6	4,500	•	1			
	2515544	355	180,0	30,0	373,0	430,0	6	7,000	•	1			
	2515546	400	195,0	33,0	427,0	482,0	6	7,360	•	1			
	2515548	450	139,0	46,0	514,0	585,0	7	10,400	•	1			
	2515550	500	138,0	46,0	530,0	585,0	7	8,700	•	1			
	2515552	560	139,0	50,0	615,0	685,0	7	14,540	•	1			
2515554	630	140,0	50,0	642,0	685,0	7	12,530	•	1				

Up to 160 mm EPDM-gasket without steel ring insert. From 200 mm EPDM-gasket with steel ring insert.

Suitable flange adapter for shutt-off valves available on request.

FLANGE ADAPTER INCL. FLANGE PN6

without gasket

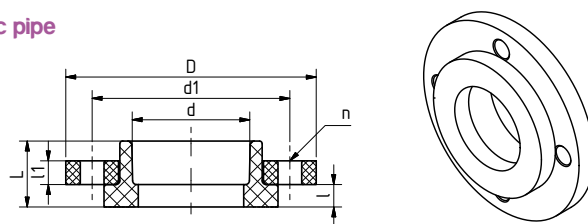
Systems: aquatherm green pipe, aquatherm blue pipe, aquatherm lilac pipe**Material:** Flange: Steel galvanized
Flange adapter: Fusiolen® PP-R**Colour:** Flange: black
Flange adapter: greend = Connection dimension, d1 = hole-circle,
PN 6 = Flange according to DIN 2641

SDR	Art. no.	Diameter d [mm]	D [mm]	d1 [mm]	L [mm]	l1 [mm]	l [mm]	n	Weight [kg]	System	PU	Box unit	Price € m/pc
<i>socket welding</i>													
6 7.4 9 11 17.6	15012	32	100,0	75,0	34,0	10,0	10,0	4	1,090	• • •	1		
	15014	40	120,0	90,0	35,5	10,0	11,0	4	1,170	• • •	1		
	15016	50	130,0	100,0	39,5	10,0	12,0	4	1,360	• • •	1		
	15018	63	140,0	110,0	43,5	10,0	14,0	4	0,886	• • •	1		
	15020	75	160,0	130,0	46,0	10,0	16,0	4	1,148	• • •	1		
	15022	90	190,0	150,0	50,0	10,0	17,0	4	1,618	• • •	1		
	15024	110	210,0	170,0	55,5	10,0	18,5	4	1,824	• • •	1		
	15027	125	240,0	200,0	63,0	12,0	20,0	8	3,945	• • •	1		

Delivery time: on request

FLANGE ADAPTER INCL. FLANGE PN6

without gasket

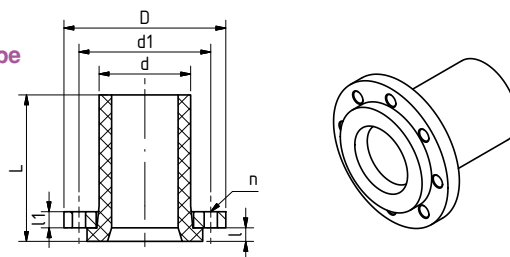
Systems: aquatherm green pipe, aquatherm blue pipe, aquatherm lilac pipe**Material:** Flange: Steel galvanized
Flange adapter: Fusiolen® PP-R**Colour:** Flange: black
Flange adapter: greend = Connection dimension, d1 = hole-circle,
PN 6 = Flange according to DIN 2641

SDR	Art. no.	Diameter d [mm]	D [mm]	d1 [mm]	L [mm]	l1 [mm]	l [mm]	n	Weight [kg]	System	PU	Box unit	Price € m/pc
6 7.4 9 11 17.6	15026	125	210,0	170,0	195,0	10,0	18,5	4	2,715	• • •	1		

Delivery time: on request

125mm Fitting with 110mm Flange adapter incl. flange PN6
Use only in combination with a fitting**FLANGE ADAPTER INCL. FLANGE PN6**

without gasket

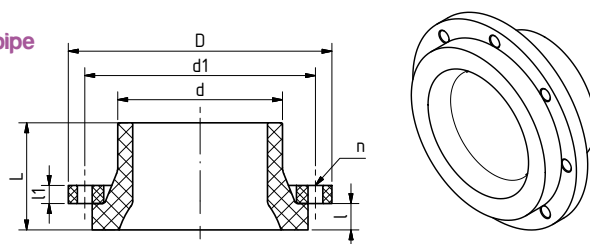
Systems: aquatherm green pipe, aquatherm blue pipe, aquatherm lilac pipe**Material:** Flange: Steel galvanized
Flange adapter: Fusiolen® PP-R**Colour:** Flange: black
Flange adapter: greend = Connection dimension, d1 = hole-circle,
PN 6 = Flange according to DIN 2641

SDR	Art. no.	Diameter d [mm]	D [mm]	d1 [mm]	L [mm]	l1 [mm]	l [mm]	n	Weight [kg]	System	PU	Box unit	Price € m/pc
<i>Butt welding</i>													
11	15031	160	265,0	225,0	93,0	12,0	25,0	8	4,136	• •	1		
	15035	200	320,0	280,0	130,0	12,0	32,0	8	6,694	• •	1		
	15039	250	375,0	335,0	130,0	12,0	35,0	8	9,500	• •	1		

Delivery time: on request

PLASTIC COATED STEEL FLANGE

Systems: aquatherm green pipe,
aquatherm blue pipe,
aquatherm lilac pipe

Material: PP/steel

Colour: grey

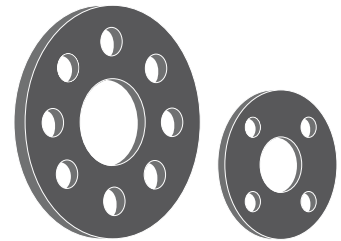
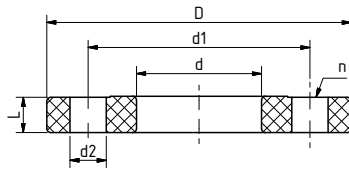

d = Connection dimension, d1 = hole-circle,
PN10/16= Flange according to DIN EN1092, DIN2501

SDR	Art. no.	fits to Art. no.	Dimension flange adapter [mm]	DN	d [mm]	d1 [mm]	D [mm]	d2 [mm]	L [mm]	n	Weight [kg]	System	PU	Box unit	Price € m/pc
<i>socket welding</i>															
	15712	15512	32	25	42,0	85,0	116,0	14,0	15,5	4	0,469	• • •	1		
	15714	15514	40	32	51,0	100,0	141,0	18,0	17,5	4	0,722	• • •	1		
	15716	15516	50	40	62,0	110,0	151,0	18,0	17,5	4	0,770	• • •	1		
	15718	15518	63	50	78,0	125,0	166,0	18,0	19,0	4	0,911	• • •	1		
	15720	15520	75	65	92,0	145,0	186,0	18,0	19,0	4	1,132	• • •	1		
	15722	15522	90	80	110,0	160,0	201,0	18,0	21,0	8	1,356	• • •	1		
	15724	15524/26	110	100	133,0	180,0	221,0	18,0	22,0	8	1,475	• • •	1		
	15726	15527	125	125	167,0	210,0	251,0	18,0	26,0	8	2,082	• • •	1		
	15730	15531 315530 2515530	160	150	178,0	240,0	286,0	22,0	27,0	8	3,671	• •	1		
6	*15734	15535 315534 2515534	200	200	235,0	295,0	341,0	22,0	28,0	8	4,709	• •	1		
7.4		15539 315538 2515538	250	250	288,0	350,0	406,0	22,0	31,0	12	7,094	• •	1		
9	*15742	15543 315542 2515542	315	300	340,0	400,0	460,0	22,0	33,5	12	9,500	• •	1		
11		15545 315544 2515544	355	350	380,0	460,0	520,0	22,0	39,0	16	15,300	• •	1		
17.6	*15746	15547 2515546	400	400	430,0	515,0	565,0	26,0	34,0	16	19,680	• •	1		
	**15748	15549 2515548	450	500	517,0	620,0	670,0	26,0	42,0	20	22,880	• •	1		
	**15750	2515550	500	500	533,0	620,0	670,0	26,0	38,0	20	19,000	• •	1		
	**15752	2515552	560	600	618,0	725,0	785,0	30,0	50,0	20	37,200	• •	1		
	**15754	2515554	630	600	645,0	725,0	785,0	30,0	40,0	20	25,800	• •	1		

*Flange PN16 ø 200–630 mm (Art. no. 15934–15954) available on request.

**Material: steel/epoxy

COUPLING SCREW JOINT

Systems: aquatherm green pipe,
aquatherm blue pipe,
aquatherm lilac pipe

Material: Fusiolen® PP-R, brass

Standard: DIN 16962, DIN EN ISO 15874

Colour: green, brassy

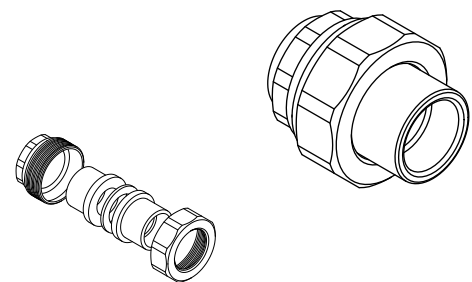
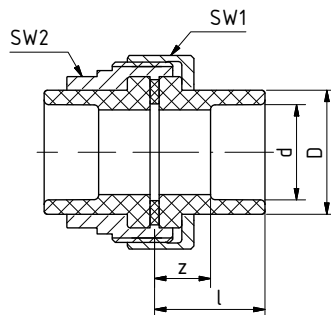

SDR	Art. no.	Dimension d [mm]	l [mm]	z [mm]	D [mm]	SW1 [mm]	SW2 [mm]	Weight [kg]	System	PU	Box unit	Price € m/pc
<i>socket welding</i>												
	15812	32	36,5	18,5	41,0	64	50	0,479	• • •	1		
6	15814	40	38,0	17,5	50,0	80	60	0,841	• • •	1		
7.4	15816	50	41,0	17,5	61,0	86	70	0,821	• • •	1		
9	15818	63	45,0	17,5	76,0	108	90	1,498	• • •	1		
11	15820	75	31,0	17,5	90,0	128	104	1,998	• • •	1		

PRINCIPLE OF FLOW-THROUGH BACK PLATE ELBOW

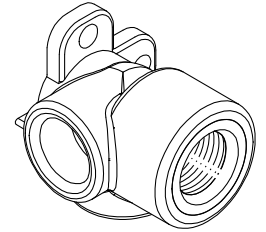
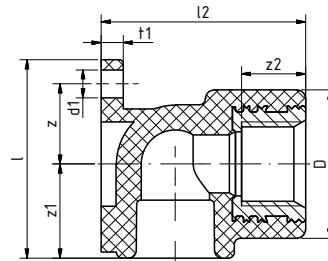

aquatherm green pipe FLOW-THROUGH BACK PLATE ELBOW 90°

Art. no.	Dimension	D [mm]	d1 [mm]	l [mm]	l2 [mm]	t1 [mm]	z [mm]	z1 [mm]	z2 [mm]	PU	Box unit	Price € m/pc
20197	20mm x 1/2" f x 20 mm	37,0	7,0	49,5	51,0	5,5	20,0	23,5	16,0	1		

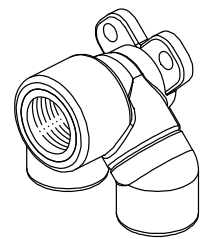
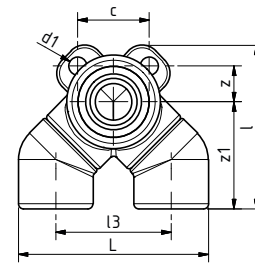
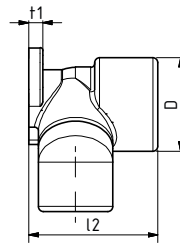

aquatherm green pipe FLOW-THROUGH BACK PLATE ELBOW, PARALLEL

Art. no.	Dimension	D [mm]	d1 [mm]	L [mm]	l [mm]	l2 [mm]	l3 [mm]	c [mm]	t1 [mm]	z [mm]	z1 [mm]	PU	Box unit	Price € m/pc
20198	20mm x 1/2" f x 20 mm	37,0	7,0	75,0	65,0	51,0	45,6	28,3	5,5	14,0	42,3	1		

COUPLING SCREW JOINT

Systems: aquatherm green pipe,
aquatherm blue pipe,
aquatherm lilac pipe

Material: Fusiolen® PP-R
Standard: DIN 16962, DIN EN ISO 15874
Colour: green

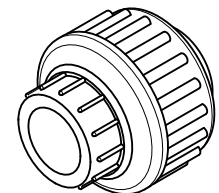
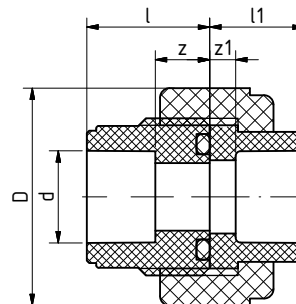

SDR	Art. no.	Dimension d [mm]	l [mm]	z [mm]	l1 [mm]	z1 [mm]	D [mm]	Weight [kg]	System	PU	Box unit	Price € m/pc
<i>socket welding</i>												
6 7.4 9 11	15838	20	26,0	12,0	20,0	5,5	46,0	0,036	• • •	10		
	15840	25	28,0	12,0	21,0	5,0	56,0	0,058	• • •	10		
	15842	32	30,0	12,0	23,0	5,0	66,0	0,089	• • •	5		
	15844	40	34,0	13,5	25,5	5,0	79,0	0,136	• • •	5		
	15846	50	39,0	15,5	28,8	5,0	87,0	0,170	• • •	5		
	15848	63	47,5	20,0	32,5	5,0	107,0	0,240	• • •	1		
	15850	75	50,0	20,0	36,0	6,0	128,0	0,546	• • •	1		

ELECTROFUSION SOCKET

- Systems:** aquatherm green pipe,
aquatherm blue pipe,
aquatherm lilac pipe
- Material:** Fusiolen® PP-R
- Standard:** DIN 16962, DIN EN ISO 15874
- Colour:** green
- Notice** do not use with 160–250 mm fittings
*do not use with aquatherm blue pipe MF OT

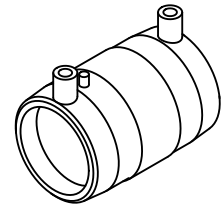
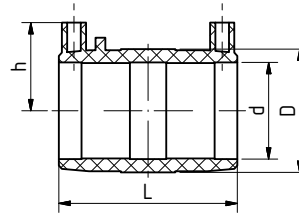

SDR	Art. no.	Dimension d [mm]	L [mm]	h [mm]	D [mm]	Weight [kg]	System	PU	Box unit	Price € m/pc
<i>Electro-socket welding</i>										
6 7.4 9 11 17.6	17208	20	70,0	36,0	31,5	0,049	• • •	1		
	17210	25	78,0	38,5	36,5	0,057	• • •	1		
	17212	32	80,0	42,5	45,0	0,077	• • •	1		
	17214	40	92,0	47,0	54,0	0,103	• • •	1		
	17216	50	103,0	52,0	65,0	0,142	• • •	1		
	17218	63	118,0	58,0	81,5	0,239	• • •	1		
	17220	75	130,0	64,5	96,0	0,347	• • •	1		
	17222	90	145,0	72,0	113,5	0,501	• • •	1		
	17224	110	160,0	82,5	139,0	0,821	• • •	1		
	17226	125	172,0	90,0	156,0	1,097	• • •	1		
	17230*	160	186,0	109,5	197,0	1,754	• • •	1		
	17234*	200	210,0	134,0	243,0	3,625	• • •	1		
	17238*	250	250,0	170,0	315,0	7,142	• • •	1		

BACK PLATE ELBOW

- Systems:** aquatherm green pipe,
aquatherm blue pipe,
aquatherm lilac pipe
- Material:** Fusiolen® PP-R, brass
Fusiolen® PP-R, stainless steel
- Standard:** DIN 16962, DIN EN ISO 15874
- Colour:** green

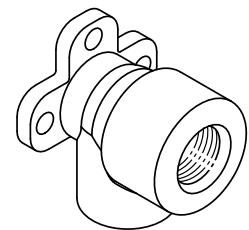
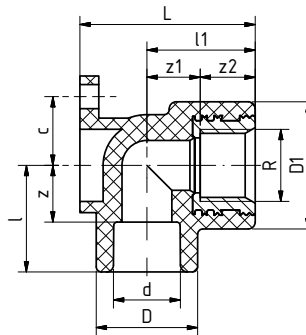

SDR	Art. no.	d [mm]	R	l [mm]	z [mm]	D [mm]	l1 [mm]	z1 [mm]	z2 [mm]	D1 [mm]	L [mm]	c [mm]	Weight [kg]	System	PU	Box unit	Price € m/pc	
<i>socket welding</i>																		
brass																		
6 7.4 11	20106	16	1/2"	31,0	18,0	29,5	31,5	18,5	13,0	37,0	51,0	20,0	0,080	•		200		
	20108	20	1/2"	31,0	16,5	29,5	31,5	18,5	13,0	37,0	51,0	20,0	0,079	• • •		200		
	20110	20	3/4"	37,0	22,5	34,0	37,0	24,0	13,0	44,0	54,0	-	0,106	• • •				
	20112	25	3/4"	37,0	21,0	34,0	37,0	24,0	13,0	44,0	54,0	-	0,105	• • •				
	20113	25	1/2"	33,5	17,5	34,0	31,0	18,0	13,0	37,0	53,0	20,0	0,080	• • •				
	stainless steel																	
	920108	20	1/2"	31,0	16,5	29,5	31,5	18,5	13,0	37,0	51,0	20,0	0,084	•				
	920110	20	3/4"	37,0	22,5	34,0	37,0	24,0	13,0	44,0	54,0	-	0,101	• • •				
	920112	25	3/4"	37,0	21,0	34,0	37,0	24,0	13,0	44,0	54,0	-	0,111	• • •				
	920113	25	1/2"	33,5	17,5	34,0	31,0	18,0	13,0	37,0	53,0	20,0	0,076	• • •				

MOUNTING PLATE

galvanized; to fix back plate elbows as double connection

Systems: aquatherm green pipe, aquatherm blue pipe, aquatherm lilac pipe

Material: iron, galvanized

Colour: zinc

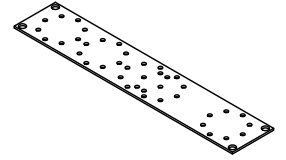
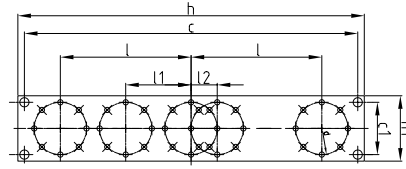

Art. no.	d [mm]	l [mm]	l1 [mm]	l2 [mm]	c [mm]	c1 [mm]	h [mm]	h1 [mm]	Weight [kg]	System	PU	Box unit	Price € m/pc
60010	40	100	50	20	255	40	265	50	0,221	• • •	1		

not suitable for connection with sound insulation plate (Art. no. 79080).
We recommend mounting rail Art. no. 79090.

MOUNTING PLATE

galvanized; to fix back plate elbows as double connection including 2 fixing plates and 4 screws

Systems: aquatherm green pipe, aquatherm blue pipe, aquatherm lilac pipe

Material: iron, galvanized

Colour: zinc

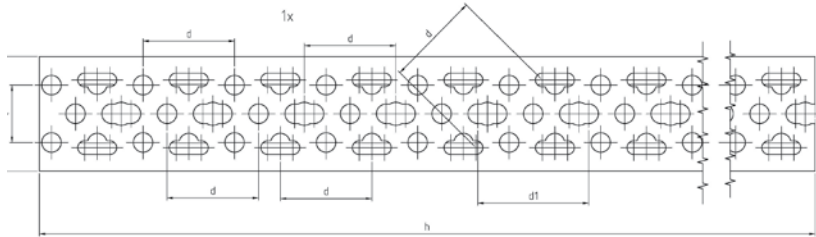
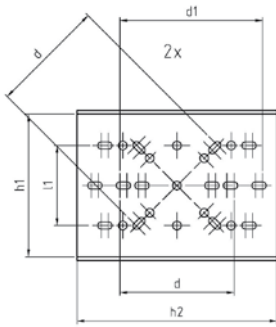
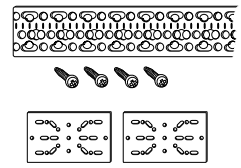

Art. no.	d [mm]	d1 [mm]	l [mm]	l1 [mm]	h [mm]	h1 [mm]	h2 [mm]	Weight [kg]	System	PU	Box unit	Price € m/pc
79090	40	50	25	28	560	70	70	0,546	• • •	1		

SOUND INSULATION PLATE

for aquatherm green pipe and aquatherm grey pipe back plate elbow

Systems: aquatherm green pipe, aquatherm blue pipe, aquatherm lilac pipe

Material: PP

Colour: white

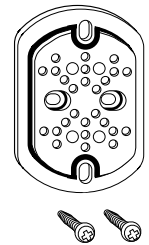
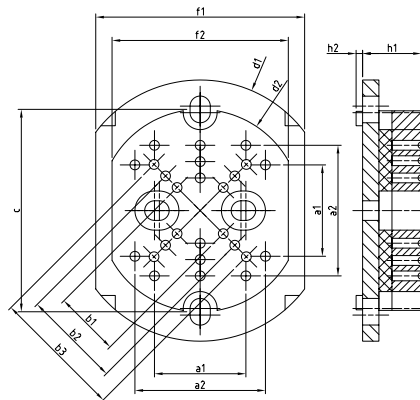

Art. no.	a1 [mm]	a2 [mm]	b1 [mm]	b2 [mm]	b3 [mm]	c [mm]	d1 [mm]	d2 [mm]	f1 [mm]	f2 [mm]	h1 [mm]	h2 [mm]	Weight [kg]	System	PU	Box unit	Price € m/pc
79080	28	20	30	40	62	62	80	62	64	54	18	2	0,058	• • •	2		

MOUNTING RAIL (DOUBLE AND SINGLE)

Systems: aquatherm green pipe,
aquatherm blue pipe,
aquatherm lilac pipe

Material: iron, galvanized

Colour: zinc

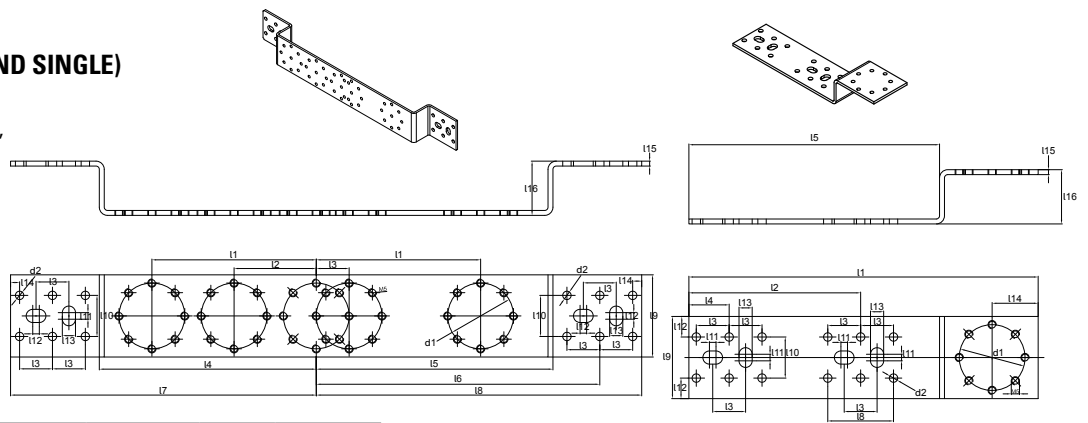

Art. no.	ø d1 [mm]	ø d2 [mm]	Weight [kg]	System	PU	Price € m/pc
79095	40	5,1	0,412	• • •	2	
79096	40	5,1	0,235	• • •	2	

DRY CONSTRUCTION WALL FITTING

Systems: aquatherm green pipe,
aquatherm blue pipe,
aquatherm lilac pipe

Material: brass

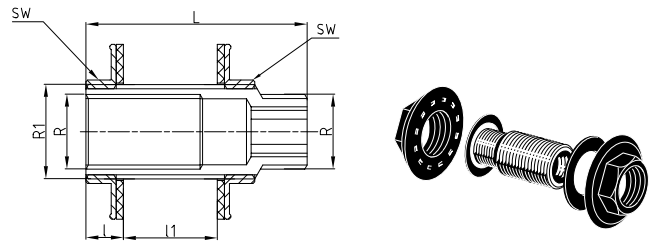

Art. no.	R	R1	l [mm]	l1 [mm]	L [mm]	SW [mm]	Weight [kg]	System	PU	Box unit	Price € m/pc
20114	1/2"	3/4"	10,5	26,0	62,0	30	0,213	• • •	10		

BACK PLATE ELBOW FOR DRY CONSTRUCTION

Systems: aquatherm green pipe,
aquatherm blue pipe,
aquatherm lilac pipe

Material: Fusiolen® PP-R, brass
Fusiolen® PP-R, stainless steel

Standard: DIN 16962, DIN EN ISO 15874

Colour: green

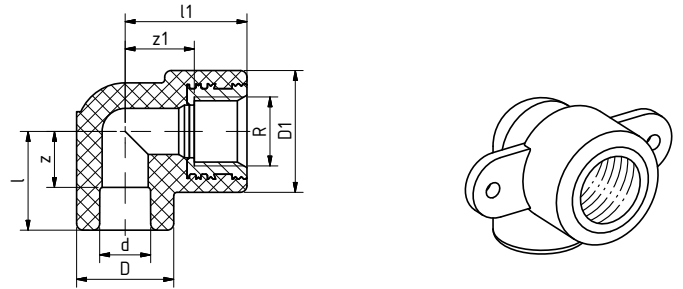

SDR	Art. no.	d [mm]	R	l [mm]	z [mm]	D [mm]	l1 [mm]	z1 [mm]	D1 [mm]	Weight [kg]	System	PU	Box unit	Price € m/pc
<i>socket welding</i>														
brass														
6	20156	16	1/2"	30,0	17,0	29,5	37,0	24,0	37,0	0,081	•		10	
7.4	20158	20	1/2"	30,0	15,5	29,5	37,0	24,0	37,0	0,079	• • •		10	
11	stainless steel													
	920158	20	1/2"	30,0	15,5	29,5	37,0	24,0	37,0	0,078	• • •		10	

TRANSITION PIECE

with counter nut, gasket and tension washer

Systems: aquatherm green pipe aquatherm blue pipe,
aquatherm lilac pipe

Material: Fusiolen® PP-R, brass

Standard: DIN 16962, DIN EN ISO 15874

Colour: green

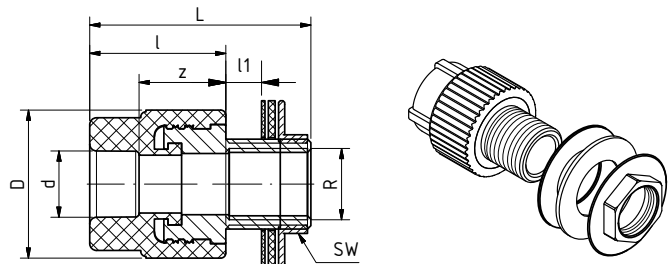

SDR	Art. no.	d [mm]	R	l [mm]	z [mm]	D [mm]	l1 [mm]	L [mm]	SW [mm]	Weight [kg]	System	PU	Box unit	Price € m/pc
<i>socket welding</i>														
6	20204	20	1/2"	40,0	25,5	43,5	13,5	65,0	29	0,204	• • •		10	
7.4														
11														

e.g. for connection of a cistern or application with mounting plate (Art. no. 60110–60115)

TRANSITION ELBOW

with counternut, gasket and tension washer

Systems: aqualtherm green pipe, aqualtherm blue pipe, aqualtherm lilac pipe

Material: Fusiolen® PP-R, brass

Standard: DIN 16962, DIN EN ISO 15874

Colour: green

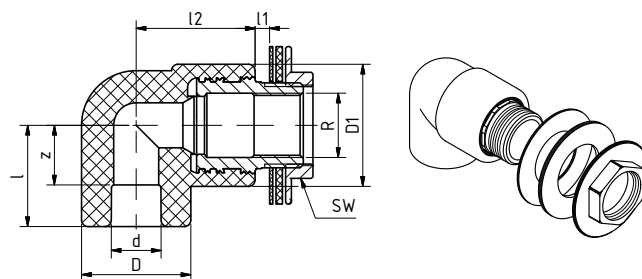

SDR	Art. no.	d [mm]	R	l [mm]	z [mm]	D [mm]	l1 [mm]	l2 [mm]	D1 [mm]	SW [mm]	Weight [kg]	System	PU	Box unit	Price € m/pc
<i>socket welding</i>															
6	20206	16	1/2"	37,0	24,0	29,5	3,5	35,0	44,0	29	0,201	•	10		
7.4	20208	20	1/2"	37,0	22,5	29,5	3,5	35,0	44,0	29	0,154	• • •	10		
11	20209	25	1/2"	37,0	21,0	34,0	3,5	37,0	44,0	29	0,206	• • •	10		

e.g. for connection of a cistern or application with mounting plate (Art. no. 60110–60115)

ASSEMBLING JIG

as water level with 2 plugs 1/2"

Systems: aqualtherm green pipe, aqualtherm blue pipe, aqualtherm lilac pipe

Material: Fusiolen® PP-R

Colour: green

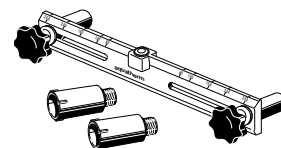

Art. no.	Weight [kg]	System	PU	Box unit	Price € m/pc
50700	0,252	• • •	1		

PLUG FOR PRESSURE TESTS

with gasket

Systems: aqualtherm green pipe, aqualtherm blue pipe, aqualtherm lilac pipe

Material: Fusiolen® PP-R

Standard: DIN 16962, DIN EN ISO 15874

Colour: green

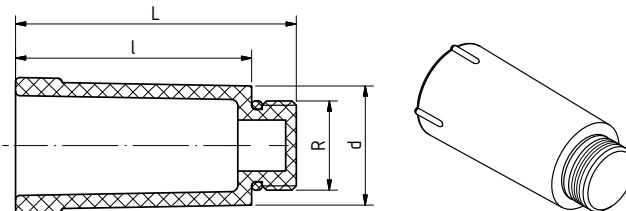

Art. no.	d [mm]	R	l [mm]	L [mm]	Weight [kg]	System	PU	Box unit	Price € m/pc
50708	28	1/2"	55,5	66,0	0,022	• • •	10		
50710	34	3/4"	55,5	66,0	0,027	• • •	10		

MOUNTING UNIT

double

Systems: aqualtherm green pipe, aqualtherm blue pipe, aqualtherm lilac pipe

Material: iron/galvanized

Colour: zinc

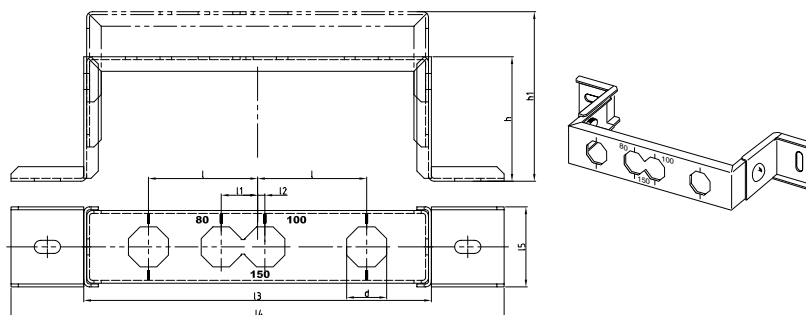

Art. no.	b [mm]	l [mm]	l1 [mm]	l2 [mm]	h [mm]	h1 [mm]	l3 [mm]	l4 [mm]	l5 [mm]	Weight [kg]	System	PU	Box unit	Price € m/pc
60110	27,5	75	25	5	92,5	122,5	239	339	55	0,630	• • •	1		

MOUNTING UNIT

single

Systems: aquatherm green pipe,
aquatherm blue pipe,
aquatherm lilac pipe

Material: iron/galvanized

Colour: zinc

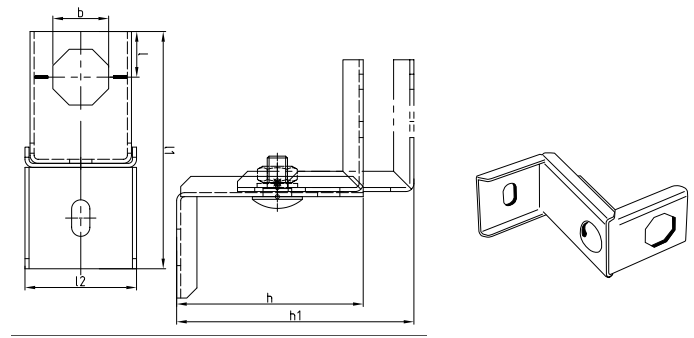

Art. no.	b [mm]	l [mm]	l1 [mm]	l2 [mm]	h [mm]	h1 [mm]	Weight [kg]	System	PU	Box unit	Price € m/pc
60115	27,5	118	22,5	55	92,5	122,5	0,278	• • •	1		

MOUNTING UNIT

with two aquatherm green pipe transition elbows (Art. no. 20208), with conternut, gasket and tension washer

Systems: aquatherm green pipe,
aquatherm blue pipe,
aquatherm lilac pipe

Material: Fusiolen® PP-R, brass
iron/galvanized

Colour: green
zinc

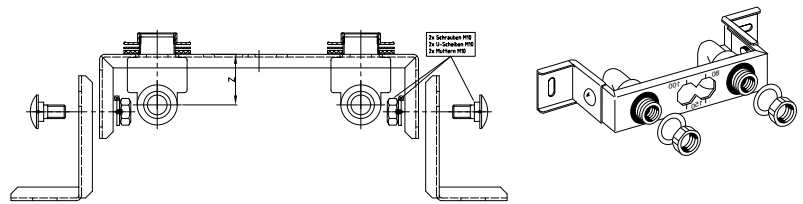

Art. no.	b [mm]	l [mm]	l1 [mm]	l2 [mm]	h [mm]	h1 [mm]	l3 [mm]	l4 [mm]	l5 [mm]	Weight [kg]	System	PU	Box unit	Price € m/pc
60150	27,5	75	25	5	92,5	122,5	239	339	55	0,942	• • •	1		

MOUNTING UNIT

with one aquatherm green pipe transition elbow (Art. no. 20208), with conternut, gasket and tension washer

Systems: aquatherm green pipe,
aquatherm blue pipe,
aquatherm lilac pipe

Material: Fusiolen® PP-R, brass
iron/galvanized

Colour: green
zinc

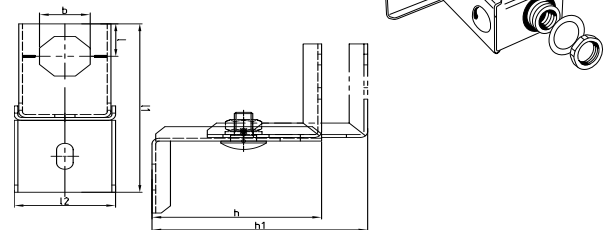

Art. no.	b [mm]	l [mm]	l1 [mm]	l2 [mm]	h [mm]	h1 [mm]	Weight [kg]	System	PU	Box unit	Price € m/pc
60155	27,5	22,5	118	55	92,5	122,5	0,434	• • •	1		

TRANSITION ELBOW

for plasterboard

Systems: aquatherm green pipe,
aquatherm blue pipe,
aquatherm lilac pipe

Material: Fusiolen® PP-R, brass

Colour: green

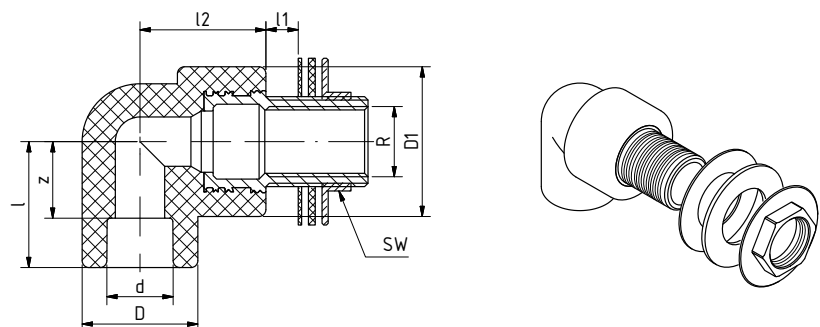

SDR	Art. no.	d [mm]	R	l [mm]	z [mm]	D [mm]	L [mm]	l1 [mm]	D1 [mm]	SW [mm]	Weight [kg]	System	PU	Box unit	Price € m/pc
6															
7.4	20210	20	1/2"	37,0	22,5	29,5	18,5	35,0	44,0	29	0,223	• • •	10		
11															

with 30 mm thread, conternut, gasket and tension washer

TRANSITION PIECE WITH FEMALE THREAD

round

Systems: aquatherm green pipe,
aquatherm blue pipe,
aquatherm lilac pipe

Material: Fusiolen® PP-R, brass
Fusiolen® PP-R, stainless steel

Standard: DIN 16962, DIN EN ISO 15874

Colour: green

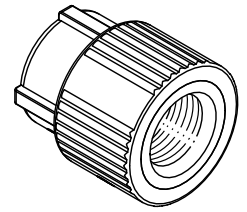
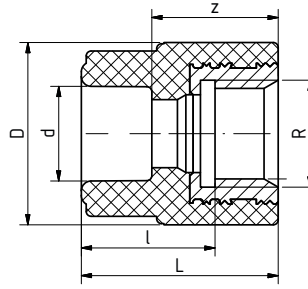

SDR	Art. no.	d [mm]	R	l [mm]	z [mm]	D [mm]	L [mm]	Weight [kg]	System	PU	Box unit	Price € m/pc
brass												
	21006	16	1/2"	28,0	28,0	38,5	41,0	0,066	•	10		
	21008	20	1/2"	27,5	26,0	37,5	40,5	0,064	• • •	10	400	
	21010	20	3/4"	27,5	26,0	43,5	40,5	0,089	• • •	10	300	
	21011	25	1/2"	29,5	26,5	38,5	42,5	0,065	• • •	10	400	
	21012	25	3/4"	27,5	24,5	43,5	40,5	0,087	• • •	10	300	
6	21013	32	3/4"	30,5	25,5	43,5	43,5	0,092	• • •	5	250	
7.4	stainless steel											
9	921008	20	1/2"	27,5	26,0	37,5	40,5	0,069	• • •	10		
11	921010	20	3/4"	27,5	26,0	43,5	40,5	0,090	• • •	10		
	921011	25	1/2"	29,5	26,5	38,5	42,5	0,069	• • •	10		
	921012	25	3/4"	27,5	24,5	43,5	40,5	0,086	• • •	10		
	921013	32	3/4"	30,5	25,5	43,5	43,5	0,092	• • •	5		
	921014	32	1/2"	28,0	23,0	37,0	41,0	0,078	• • •	5		

TRANSITION PIECE WITH FEMALE THREAD

hex shaped threaded transition

Systems: [aquatherm green pipe](#),
[aquatherm blue pipe](#),
[aquatherm lilac pipe](#)

Material: Fusiolen® PP-R, brass
Fusiolen® PP-R, stainless steel

Standard: DIN 16962, DIN EN ISO 15874

Colour: green

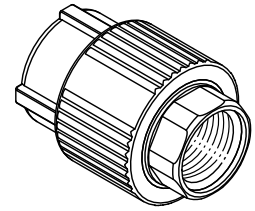
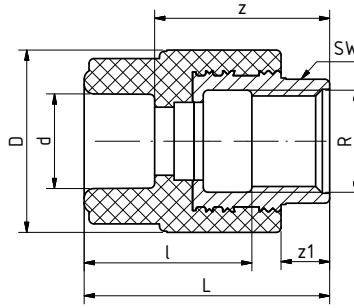

SDR	Art. no.	d [mm]	R	l [mm]	z [mm]	z1 [mm]	D [mm]	L [mm]	SW [mm]	Weight [kg]	System	PU	Box unit	Price € m/pc
brass														
6 7.4 9 11	21106	16	1/2"	34,5	37,5	10,0	38,5	50,5	24	0,089	•	10		
	21108	20	1/2"	34,5	36,0	10,0	38,5	50,5	24	0,078	• • •	10	400	
	21110	20	3/4"	29,0	35,5	10,0	43,5	50,0	31	0,112	• • •	10	300	
	21111	25	1/2"	36,0	36,0	10,0	38,5	52,0	24	0,081	• • •	10	300	
	21112	25	3/4"	29,0	34,0	10,0	43,5	50,0	31	0,109	• • •	10	300	
	21113	32	3/4"	32,0	35,0	10,0	43,5	53,0	31	0,114	• • •	5	250	
	21114	32	1"	37,5	41,5	14,0	60,0	59,5	39	0,239	• • •	5	125	
	21115	40	1"	40,0	41,5	14,0	60,0	62,0	39	0,227	• • •	5		
	21116	40	1 1/4"	40,0	42,5	15,0	74,0	63,0	50	0,385	• • •	5		
	21117	50	1 1/4"	43,0	42,5	15,0	74,0	66,0	50	0,404	• • •	5		
	21118	50	1 1/2"	45,0	43,5	15,0	84,0	67,0	55	0,418	• • •	5		
	21119	63	1 1/2"	51,5	46,0	15,0	84,0	73,5	55	0,442	• • •	1		
21120	63	2"	51,0	49,5	19,0	101,0	77,0	67	0,600	• • •	1			
21122	75	2"	51,0	47,0	19,0	100,0	77,0	67	0,608	• • •	1			
stainless steel														
	921114	32	1"	37,5	41,5	14,0	60,0	59,5	39	0,232	• • •	5		
	921115	40	1"	40,0	41,5	14,0	60,0	62,0	39	0,219	• • •	5		
	921116	40	1 1/4"	40,0	42,5	15,0	74,0	63,0	50	0,331	• • •	5		
	921117	50	1 1/4"	43,0	42,5	15,0	74,0	66,0	50	0,351	• • •	5		
	921118	50	1 1/2"	45,0	43,5	15,0	84,0	67,0	55	0,445	• • •	5		
	921119	63	1 1/2"	51,5	46,0	15,0	84,0	73,5	55	0,425	• • •	1		
	921120	63	2"	51,0	49,5	19,0	101,0	77,0	67	0,196	• • •	1		
	921122	75	2"	51,0	47,0	19,0	100,0	77,0	67	0,676	• • •	1		

TRANSITION PIECE WITH MALE THREAD

round, self sealing

Systems: [aquatherm green pipe](#), [aquatherm blue pipe](#),
[aquatherm lilac pipe](#)

Material: Fusiolen® PP-R, brass

Standard: DIN 16962, DIN EN ISO 15874

Colour: green

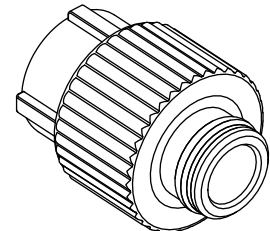
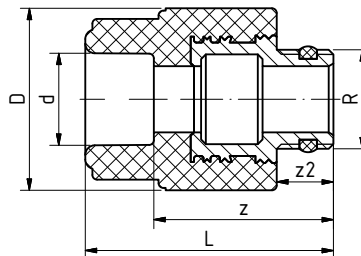

SDR	Art. no.	d [mm]	R	L [mm]	z [mm]	z2 [mm]	D [mm]	Weight [kg]	System	PU	Box unit	Price € m/pc
6	21258	20	1/2"	52,5	38,0	12,0	38,5	0,090	• • •	10		
7.4	21261	25	1/2"	54,0	38,0	12,0	38,5	0,078	• • •	10		
11	21262	25	3/4"	53,5	37,5	13,0	38,5	0,085	• • •	10		

TRANSITION PIECE WITH MALE THREAD

round

Systems: aquatherm green pipe,
aquatherm blue pipe,
aquatherm lilac pipe

Material: Fusiolen® PP-R, brass
Fusiolen® PP-R, stainless steel

Standard: DIN 16962, DIN EN ISO 15874

Colour: green

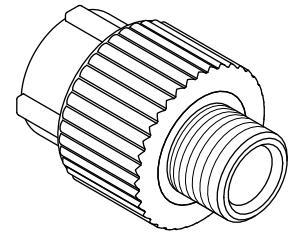
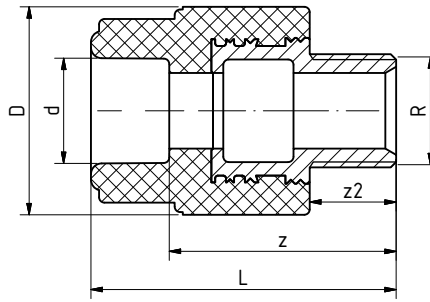

SDR	Art. no.	d [mm]	R	L [mm]	z [mm]	z2 [mm]	D [mm]	Weight [kg]	System	PU	Box unit	Price € m/pc	
brass													
6 7.4 9 11	21206	16	1/2"	56,5	43,5	16,0	38,5	0,097	•	10			
	21208	20	1/2"	56,5	42,0	16,0	38,5	0,084	• • •	10	350		
	21210	20	3/4"	57,5	43,0	17,0	38,5	0,109	• • •	10	300		
	21211	25	1/2"	58,0	42,0	16,0	38,5	0,085	• • •	10	300		
	21212	25	3/4"	57,5	41,5	17,0	38,5	0,090	• • •	10	350		
	21213	32	3/4"	59,5	41,5	17,0	38,5	0,095	• • •	5	250		
	stainless steel												
	921208	20	1/2"	56,5	42,0	16,0	38,5	0,096	• • •	10			
	921210	20	3/4"	57,5	43,0	17,0	38,5	0,108	• • •	10			
	921211	25	1/2"	58,0	42,0	16,0	38,5	0,098	• • •	10			
	921212	25	3/4"	57,5	41,5	17,0	38,5	0,108	• • •	10			
921213	32	3/4"	59,5	41,5	17,0	38,5	0,115	• • •	5				

TRANSITION PIECE WITH MALE THREAD

with hexagon or *octagon

Systems: aquatherm green pipe,
aquatherm blue pipe,
aquatherm lilac pipe

Material: Fusiolen® PP-R, brass
Fusiolen® PP-R, stainless steel

Standard: DIN 16962, DIN EN ISO 15874

Colour: green

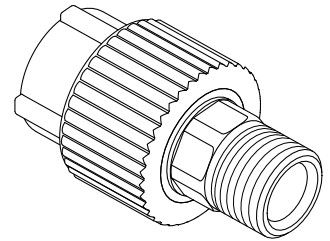
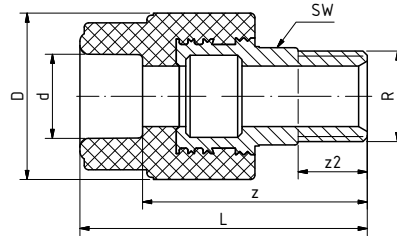

SDR	Art. no.	d [mm]	R	SW [mm]	L [mm]	z [mm]	z2 [mm]	D [mm]	Weight [kg]	System	PU	Box unit	Price € m/pc
brass													
	21306	16	1/2"	22	66,5	53,5	16,0	38,5	0,119	•	10		
	21308	20	1/2"	22	66,5	52,0	16,0	38,5	0,104	• • •	10		
	21310	20	3/4"	24	67,5	53,0	17,0	38,5	0,129	• • •	10		
	21311	25	1/2"	21	68,0	52,0	16,0	38,5	0,107	• • •	10		
	21312	25	3/4"	24	67,5	51,5	17,0	38,5	0,103	• • •	10	300	
	21314	32	1"	32	78,5	60,5	20,0	53,0	0,216	• • •	5	125	
	21316	32	1 1/4"	42	81,0	63,0	21,0	68,0	0,318	• • •	5	100	
	21317	40	1"	32	81,0	60,5	20,0	52,0	0,222	• • •	5	100	
	21318	40	1 1/4"	42	84,5	64,0	21,0	68,0	0,324	• • •	5	80	
	21319	50	1 1/4"	42	85,5	62,0	21,0	68,0	0,351	• • •	5		
	21320	50	1 1/2"	46	88,5	65,0	22,0	74,0	0,425	• • •	5		
	21321	63	1 1/2"	46	94,5	67,0	22,0	72,5	0,467	• • •	1		
6	21322	63	2"	50	102,5	75,0	23,5	84,0	0,685	• • •	1		
7.4	21323	75	2"	50	102,0	72,0	23,5	84,0	0,733	• • •	1		
9	21324	75	2 1/2"	65	105,0	75,0	26,7	100,0	0,970	• • •	1		
11	21325*	90	3"	85	121,0	88,0	30,0	120,0	1,326	• • •	1		
	21327*	110	4"	105	148,0	111,0	39,0	147,0	2,730	• • •	1		
stainless steel													
	921314	32	1"	32	78,5	60,5	20,0	53,0	0,204	• • •	5		
	921316	32	1 1/4"	41	81,0	63,0	21,0	68,0	0,360	• • •	5		
	921317	40	1"	32	81,0	60,5	20,0	52,0	0,251	• • •	5		
	921318	40	1 1/4"	41	84,5	64,0	21,0	68,0	0,362	• • •	5		
	921319	50	1 1/4"	41	85,5	62,0	21,0	68,0	0,389	• • •	5		
	921320	50	1 1/2"	46	88,5	65,0	22,0	74,0	0,480	• • •	5		
	921321	63	1 1/2"	46	94,5	67,0	22,0	72,5	0,523	• • •	1		
	921322	63	2"	50	102,5	75,0	23,5	84,0	0,708	• • •	1		
	921323	75	2"	50	102,0	72,0	23,5	84,0	0,699	• • •	1		

TRANSITION PIECE WITH MALE THREAD

self-sealing, with hex shaped threaded transition
male/male

Systems: aquatherm green pipe, aquatherm blue pipe,
aquatherm lilac pipe

Material: Fusiolen® PP-R, brass

Standard: DIN 16962, DIN EN ISO 15874

Colour: green

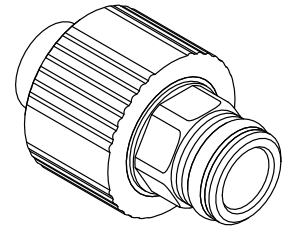
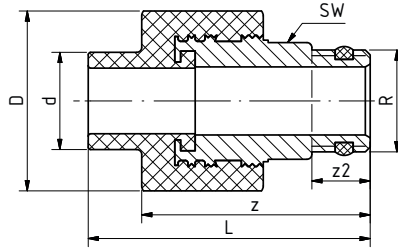

SDR	Art. no.	d [mm]	R	L [mm]	z [mm]	z2 [mm]	D [mm]	SW [mm]	Weight [kg]	System	PU	Box unit	Price € m/pc
6													
7.4	21355	20	1/2"	59,0	48,0	13,0	38,5	22	0,107	• • •	10		
11													

TRANSITION PIECE WITH MALE THREAD

self-sealing, with hex shaped threaded transition
female/male

Systems: aquatherm green pipe,
aquatherm blue pipe,
aquatherm lilac pipe

Material: Fusiolen® PP-R, brass

Standard: DIN 16962, DIN EN ISO 15874

Colour: green

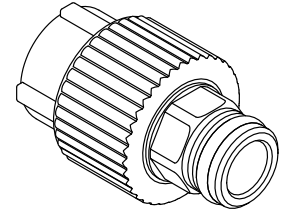
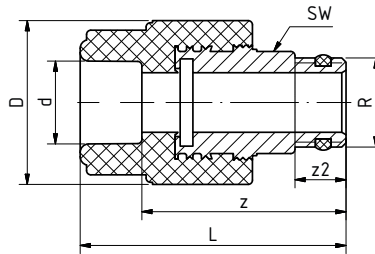

SDR	Art. no.	d [mm]	R	L [mm]	z [mm]	z2 [mm]	D [mm]	SW [mm]	Weight [kg]	System	PU	Box unit	Price € m/pc
6	21356	16	1/2"	63,5	50,5	13,0	38,5	22	0,112	•	10		
7.4													
11	21358	20	1/2"	63,5	49,0	13,0	38,5	22	0,111	• • •	10		

TRANSITION ELBOW WITH FEMALE THREAD

Systems: aquatherm green pipe,
aquatherm blue pipe,
aquatherm lilac pipe

Material: Fusiolen® PP-R, brass
Fusiolen® PP-R, stainless steel

Standard: DIN 16962, DIN EN ISO 15874

Colour: green

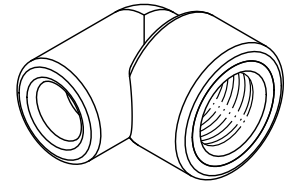
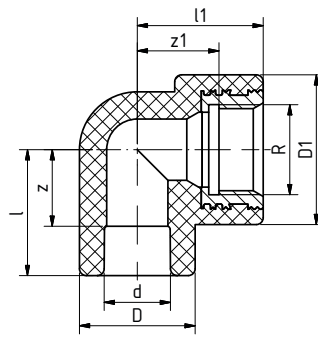

SDR	Art. no.	d [mm]	R	l [mm]	z [mm]	D [mm]	l1 [mm]	z1 [mm]	D1 [mm]	Weight [kg]	System	PU	Box unit	Price € m/pc
brass														
	23006	16	1/2"	31,5	18,5	29,5	37,0	24,0	37,0	0,072	•	10		
	23008	20	3/4"	37,0	22,5	34,0	37,0	24,0	44,0	0,102	• • •	10		
	23010	20	1/2"	31,0	16,5	29,5	31,5	18,5	37,0	0,076	• • •	10	300	
	23012	25	3/4"	37,0	21,0	34,0	37,0	24,0	44,0	0,100	• • •	10	200	
	23014	25	1/2"	33,5	17,5	34,0	31,5	18,5	37,0	0,075	• • •	10	250	
	23016	32	3/4"	27,5	9,5	43,0	51,0	38,0	44,0	0,104	• • •	5		
6	23018	32	1"	34,0	16,0	43,0	66,5	44,5	60,5	0,249	• • •	5		
7.4	stainless steel													
9	923008	20	3/4"	37,0	22,5	29,5	37,0	24,0	37,0	0,095	• • •	10		
11	923010	20	1/2"	31,0	16,5	29,5	31,5	18,5	37,0	0,081	• • •	10		
	923012	25	3/4"	37,0	21,0	34,0	37,0	24,0	44,0	0,101	• • •	10		
	923014	25	1/2"	33,5	17,5	34,0	31,5	18,5	37,0	0,082	• • •	10		
	923015	32	1/2"	35,0	17,0	43,0	37,0	24,0	37,0	0,112	• • •	5		
	923016	32	3/4"	27,5	9,5	43,0	51,0	38,0	44,0	0,097	• • •	5		
	923018	32	1"	34,0	16,0	43,0	66,5	44,5	60,5	0,240	• • •	5		

TRANSITION ELBOW WITH FEMALE THREAD

Systems: aquatherm green pipe,
aquatherm blue pipe,
aquatherm lilac pipe

Material: Fusiolen® PP-R, brass

Standard: DIN 16962, DIN EN ISO 15874

Colour: green

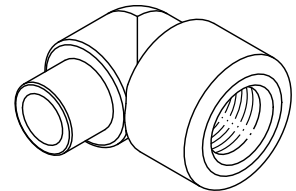
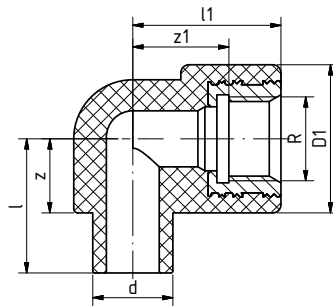

SDR	Art. no.	d [mm]	R	l [mm]	z [mm]	l1 [mm]	z1 [mm]	D1 [mm]	Weight [kg]	System	PU	Box unit	Price € m/pc
6	23208	20	1/2"	33,5	18,5	37,0	24,0	37,0	0,076	• • •	10		

TRANSITION ELBOW WITH MALE THREAD

Systems: aquatherm green pipe,
aquatherm blue pipe,
aquatherm lilac pipe

Material: Fusiolen® PP-R, brass
Fusiolen® PP-R, stainless steel

Standard: DIN 16962, DIN EN ISO 15874

Colour: green

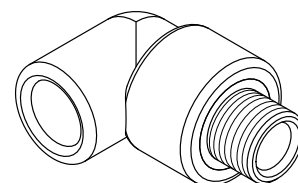
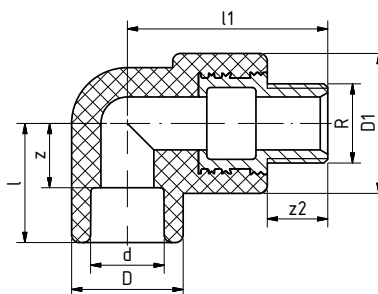

SDR	Art. no.	d [mm]	R	l [mm]	l1 [mm]	z [mm]	z2 [mm]	D [mm]	D1 [mm]	Weight [kg]	System	PU	Box unit	Price € m/pc	
brass															
6 7.4 9 11	23504	16	1/2"	31,5	53,0	18,5	16,0	29,5	37,0	0,109	•	10			
	23506	20	1/2"	31,5	53,0	17,0	16,0	29,5	37,0	0,108	• • •	10			
	23508	20	3/4"	31,5	54,0	17,0	17,0	34,0	38,0	0,128	• • •	10			
	23510	25	3/4"	31,5	54,0	15,5	17,0	34,0	38,0	0,104	• • •	10			
	23512	32	3/4"	27,5	68,0	9,5	17,0	43,0	38,0	0,112	• • •	5			
	23514	32	1"	31,0	85,5	13,0	20,0	43,0	52,0	0,231	• • •	5			
	stainless steel														
	923506	20	1/2"	31,5	53,0	17,0	16,0	29,5	37,0	0,035	• • •	10			
	923508	20	3/4"	31,5	54,0	17,0	17,0	34,0	38,0	0,123	• • •	10			
	923510	25	3/4"	31,5	54,0	15,5	17,0	34,0	38,0	0,121	• • •	10			
	923512	32	3/4"	27,5	68,0	9,5	17,0	43,0	38,0	0,128	• • •	5			

THREADED BRANCH TEE WITH FEMALE THREAD

Systems: aquatherm green pipe,
aquatherm blue pipe,
aquatherm lilac pipe

Material: Fusiolen® PP-R, brass
Fusiolen® PP-R, stainless steel

Standard: DIN 16962, DIN EN ISO 15874

Colour: green

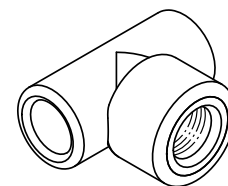
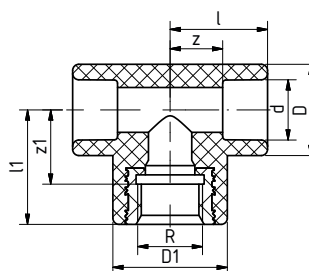

SDR	Art. no.	d [mm]	R	l [mm]	z [mm]	D [mm]	l1 [mm]	z1 [mm]	D1 [mm]	Weight [kg]	System	PU	Box unit	Price € m/pc	
brass															
6 7.4 9 11	25004	16	1/2"	31,5	18,5	29,5	37,0	24,0	37,0	0,089	•	10			
	25006	20	1/2"	31,5	17,0	29,5	37,0	24,0	37,0	0,086	• • •	10	250		
	25008	20	3/4"	37,0	22,5	34,0	37,0	24,0	44,0	0,121	• • •	10	170		
	25010	25	1/2"	34,5	18,5	34,0	38,0	25,0	37,0	0,090	• • •	10	200		
	25012	25	3/4"	37,0	21,0	34,0	37,0	24,0	44,0	0,109	• • •	10	150		
	25013	32	1/2"	35,0	17,0	43,0	37,0	24,0	37,0	0,103	• • •	5			
	25014	32	3/4"	27,5	9,5	43,0	51,0	38,0	44,0	0,111	• • •	5			
	25016	32	1"	31,5	13,5	43,0	67,0	45,0	60,0	0,255	• • •	5			
	25018	40	1/2"	42,0	21,5	52,0	40,0	27,0	37,0	0,142	• • •	5			
	25019	40	3/4"	40,5	20,0	52,0	40,5	27,5	52,0	0,147	• • •	5			
	25020	40	1"	41,5	21,0	52,0	56,0	34,0	60,0	0,276	• • •	5			
	25022	50	1"	49,5	26,0	68,0	63,5	41,5	68,3	0,385	• • •	5			
	25030	50	1/2"	49,5	26,0	68,0	44,5	31,5	43,0	0,237	• • •	5			
	25031	50	3/4"	49,5	26,0	68,0	44,5	31,5	43,0	0,243	• • •	5			
	stainless steel														
	925006	20	1/2"	31,5	17,0	29,5	37,0	24,0	37,0	0,087	• • •	10			
925008	20	3/4"	37,0	22,5	34,0	37,0	24,0	44,0	0,108	• • •	10				
925010	25	1/2"	34,5	18,5	34,0	38,0	25,0	37,0	0,093	• • •	10				
925012	25	3/4"	37,0	21,0	34,0	37,0	24,0	44,0	0,111	• • •	10				
925013	32	1/2"	35,0	17,0	43,0	37,0	24,0	37,0	0,113	• • •	5				
925014	32	3/4"	27,5	9,5	43,0	51,0	38,0	44,0	0,111	• • •	5				
925016	32	1"	31,5	13,5	43,0	67,0	45,0	60,0	0,082	• • •	5				

NOTICE: aquatherm green pipe metal compound fittings are manufactured from fusiolen PP-R and brass. Metal inserts, without hex shaped spanner flat, with 1/2" and 3/4" f are also available in stainless steel.

THREADED BRANCH TEE WITH MALE THREAD

Systems: aquatherm green pipe,
aquatherm blue pipe,
aquatherm lilac pipe

Material: Fusiolen® PP-R, brass

Standard: DIN 16962, DIN EN ISO 15874

Colour: green

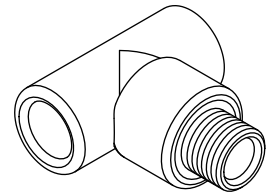
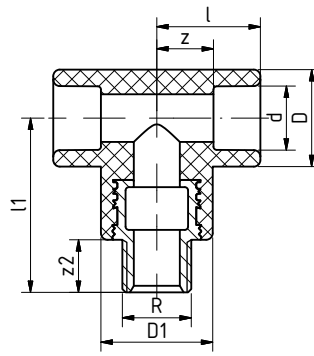

SDR	Art. no.	d [mm]	R	l [mm]	z [mm]	D [mm]	z2 [mm]	D1 [mm]	Weight [kg]	System	PU	Box unit	Price € m/pc
6													
7.4	25506	20	1/2"	31,5	17,0	29,5	16,0	37,0	0,102	• • •	10		
11													

TRANSITION COUPLING WITH MALE THREAD

with union nut and welding socket

Systems: aquatherm green pipe,
aquatherm blue pipe,
aquatherm lilac pipe

Material: Fusiolen® PP-R, brass

Standard: DIN 16962, DIN EN ISO 15874

Colour: green

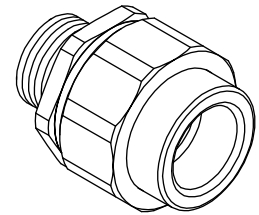
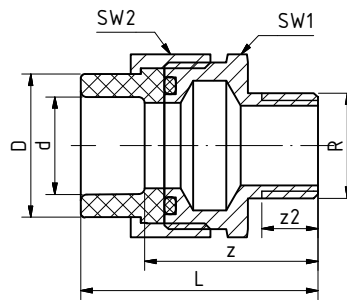

SDR	Art. no.	d [mm]	R	L [mm]	z [mm]	z2 [mm]	D [mm]	SW1 [mm]	SW2 [mm]	Weight [kg]	System	PU	Box unit	Price € m/pc
	26608	20	1/2"	52,5	38,0	13,5	27,5	34	36	0,145	• • •	1		
6	26610	25	3/4"	59,5	43,5	14,5	36,0	42	46	0,243	• • •	1		
7.4	26612	32	1"	64,5	46,5	16,8	41,5	48	52	0,336	• • •	1		
9	26614	40	1 1/4"	70,0	49,5	19,1	53,0	60	64	0,632	• • •	1		
11	26616	50	1 1/2"	84,8	61,3	22,0	59,0	48	72	0,624	• • •	1		
	26618	63	2"	95,5	68,0	25,0	74,0	62	89	1,045	• • •	1		

TRANSITION COUPLING WITH FEMALE THREAD

with union nut and welding socket

Systems: aquatherm green pipe,
aquatherm blue pipe,
aquatherm lilac pipe

Material: Fusiolen® PP-R, brass

Standard: DIN 16962, DIN EN ISO 15874

Colour: green

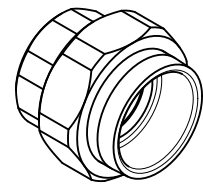
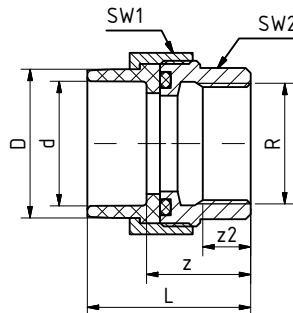

SDR	Art. no.	d [mm]	R	z [mm]	z2 [mm]	D [mm]	L [mm]	SW1 [mm]	SW2 [mm]	Weight [kg]	System	PU	Box unit	Price € m/pc
	26638	20	1/2"	30,5	15,0	27,5	45,0	36	24	0,112	• • •	1		
6	26640	25	3/4"	33,0	15,5	36,0	49,0	46	32	0,193	• • •	1		
7.4	26642	32	1"	36,0	15,0	41,5	54,0	52	40	0,291	• • •	1		
9	26644	40	1 1/4"	36,0	20,0	53,0	56,5	64	47	0,423	• • •	1		
11	26646	50	1 1/2"	41,3	19,0	59,0	64,8	72	57	0,610	• • •	1		
	26648	63	2"	47,0	18,0	74,0	74,5	89	68	0,924	• • •	1		

Notice: aquatherm green pipe metal compound fittings are manufactured from fusiolen PP-R and brass. Metal inserts, without hex shaped spanner flat, with 1/2" and 3/4" f are also available in stainless steel.

LOOSE NUT ADAPTER

length: 100 mm, with gasket

Systems: **aquatherm green pipe,**
aquatherm blue pipe,
aquatherm lilac pipe

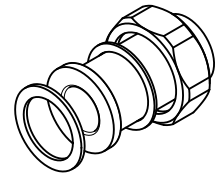
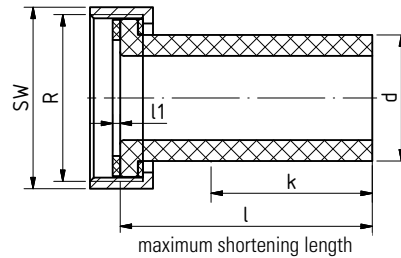
Material: Fusiolen® PP-R, brass**Standard:** DIN 16962, DIN EN ISO 15874**Colour:** green

SDR	Art. no.	d [mm]	Nut R	l [mm]	l1 [mm]	k [mm]	SW [mm]	Weight [kg]	System	PU	Box unit	Price € m/pc
6 7.4 9 11	26708	20	1"	100,0	3,0	65,0	36	0,079	• • •	1		
	26710	25	1 1/4"	100,0	3,0	62,0	46	0,104	• • •	1		
	26712	32	1 1/2"	100,0	3,0	58,0	52	0,175	• • •	1		
	26714	40	2"	100,0	3,0	53,0	64	0,258	• • •	1		
	26716	50	2 1/4"	100,0	3,0	49,0	72	0,344	• • •	1		
	26718	63	2 3/4"	100,0	3,0	43,0	89	0,583	• • •	1		
	26720	75	3 1/2"	100,0	3,0	34,0	110	0,918	• • •	1		
26722	90	4"	100,0	3,0	26,0	120	1,238	• • •	1			

WATER METER NUT ADAPTER

with gasket

Systems: **aquatherm green pipe,**
aquatherm blue pipe,
aquatherm lilac pipe

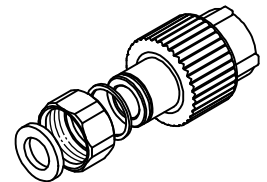
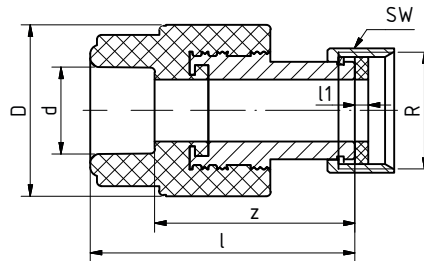
Material: Fusiolen® PP-R, brass**Standard:** DIN 16962, DIN EN ISO 15874**Colour:** green

SDR	Art. no.	d [mm]	l [mm]	l1 [mm]	z [mm]	D [mm]	R	SW [mm]	Weight [kg]	System	PU	Box unit	Price € m/pc
6	26808	20	59,5	3,0	45,0	38,5	3/4"	30	0,136	• • •	1		
7.4	26810	25	61,0	3,0	45,0	38,5	3/4"	30	0,155	• • •	1		
9	26812	32	62,0	3,0	44,0	43,5	3/4"	30	0,162	• • •	1		

NUT ADAPTER

ISO-standard

Systems: **aquatherm green pipe,**
aquatherm blue pipe,
aquatherm lilac pipe

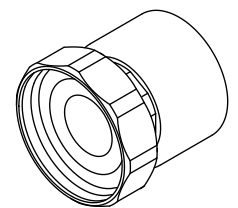
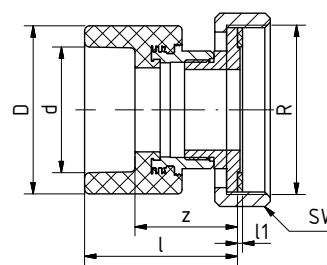
Material: Fusiolen® PP-R, brass**Standard:** DIN 16962, DIN EN ISO 15874**Colour:** green

SDR	Art. no.	d [mm]	Nut R	l [mm]	l1 [mm]	z [mm]	D [mm]	SW [mm]	Weight [kg]	System	PU	Box unit	Price € m/pc
6 7.4 9 11	27010	20	1"	58,5	3,0	34,0	38,5	36	0,182	• • •	10		
	27011	25	1"	60,0	3,0	44,0	38,5	36	0,186	• • •	10		
	27012	25	1 1/4"	60,0	3,0	44,0	43,5	46	0,274	• • •	10		
	27013	32	1 1/4"	63,0	3,0	45,0	43,5	46	0,279	• • •	5		
	27014	32	1 1/2"	69,5	3,0	51,5	60,0	52	0,446	• • •	5		
	27015	40	1 1/2"	72,0	3,0	51,5	60,0	52	0,421	• • •	5		
	27016	40	2"	72,0	3,0	51,5	74,0	64	0,719	• • •	5		
	27017	50	2"	77,0	3,0	53,5	74,0	64	0,736	• • •	5		
	27018	50	2 1/4"	77,0	3,0	53,5	84,0	72	0,831	• • •	5		
	27019	63	2 1/4"	83,5	3,0	56,0	84,0	72	0,889	• • •	1		
	27020	63	2 3/4"	82,5	3,0	55,0	101,0	89	1,306	• • •	1		
	27021	75	2 3/4"	85,0	3,0	55,0	100,0	89	1,275	• • •	1		
	27022	75	3 1/2"	91,0	3,0	61,0	100,0	110	1,818	• • •	1		

COUNTERPART

with welding socket and male thread for ISO-standard adapter

Systems: aquatherm green pipe,
aquatherm blue pipe,
aquatherm lilac pipe

Material: Fusiolen® PP-R, brass

Standard: DIN 16962, DIN EN ISO 15874

Colour: green

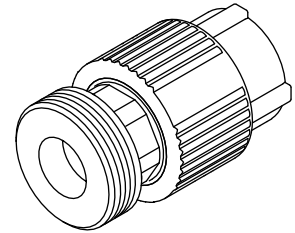
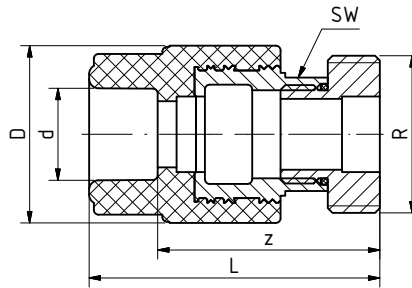

SDR	Art. no.	d [mm]	Thread R	L [mm]	z [mm]	D [mm]	SW [mm]	Weight [kg]	System	PU	Box unit	Price € m/pc
6 7.4 9 11	27310	20	1"	61,5	47,0	37,5	24	0,151	• • •	10		
	27311	25	1"	63,0	47,0	37,5	24	0,153	• • •	10		
	27312	25	1 1/4"	63,0	47,0	43,5	31	0,221	• • •	10		
	27313	32	1 1/4"	66,0	48,0	43,5	31	0,226	• • •	5		
	27314	32	1 1/2"	76,5	58,5	60,0	39	0,408	• • •	5		
	27315	40	1 1/2"	79,0	58,5	60,0	39	0,414	• • •	5		
	27316	40	2"	79,0	58,5	74,0	50	0,650	• • •	5		
	27317	50	2"	82,0	58,5	74,0	50	0,634	• • •	5		
	27318	50	2 1/4"	83,0	59,5	84,0	55	0,750	• • •	5		
	27319	63	2 1/4"	89,5	62,0	84,0	55	0,728	• • •	1		
	27320	63	2 3/4"	95,0	65,5	101,0	67	1,093	• • •	1		
	27321	75	2 3/4"	95,0	65,0	100,0	67	1,117	• • •	1		
27322	75	3 1/2"	100,0	70,0	100,0	67	1,436	• • •	1			

BRASS COUNTERPART

with female thread, for ISO-standard adapter/loose nut adapter

Systems: aquatherm green pipe,
aquatherm blue pipe,
aquatherm lilac pipe

Material: brass

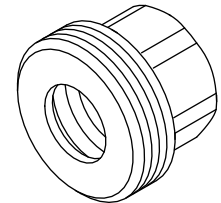
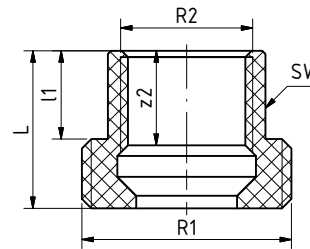

SDR	Art. no.	Male thread R1	Female thread R2	L [mm]	l1 [mm]	z2 [mm]	SW [mm]	Weight [kg]	System	PU	Box unit	Price € m/pc
6 7.4 9 11	27510	1"	1/2"	25,0	14,0	15,0	25	0,063	• • •	10		
	27512	1 1/4"	3/4"	26,0	12,5	14,0	32	0,119	• • •	10		
	27514	1 1/2"	1"	31,0	15,0	17,0	40	0,175	• • •	5		
	27516	2"	1 1/4"	33,0	17,0	22,0	47	0,263	• • •	5		
	27518	2 1/4"	1 1/2"	36,0	20,0	19,0	57	0,333	• • •	5		
	27520	2 3/4"	2"	42,0	24,0	24,0	68	0,517	• • •	1		
	27522	3 1/2"	2 1/2"	46,0	24,0	27,0	84	0,801	• • •	1		
	27524	4"	3"	46,0	27,0	27,0	97	0,943	• • •	1		

Notice: aquatherm green pipe metal compound fittings are manufactured from fusiolen PP-R and brass. Metal inserts, without hex shaped spanner flat, with 1/2" and 3/4" f are also available in stainless steel.

BRASS COUNTERPART

with male thread, for ISO-standard adapter/loose nut adapter

Systems: aquatherm green pipe,
aquatherm blue pipe,
aquatherm lilac pipe

Material: brass

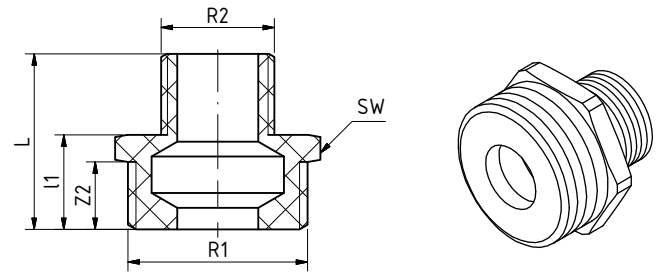

SDR	Art. no.	Thread R1	Thread R2	L [mm]	l1 [mm]	z2 [mm]	SW [mm]	Weight [kg]	System	PU	Box unit	Price € m/pc
6 7.4 9 11	27710	1"	1/2"	32,5	17,5	10,5	34	0,109	• • •	10		
	27712	1 1/4"	3/4"	38,5	21,0	12,5	42	0,188	• • •	10		
	27714	1 1/2"	1"	41,5	22,5	13,5	48	0,211	• • •	5		
	27716	2"	1 1/4"	44,5	22,5	13,0	60	0,363	• • •	5		
	27718	2 1/4"	1 1/2"	56,0	34,0	16,0	48	0,472	• • •	5		
	27720	2 3/4"	2"	63,0	38,0	16,0	62	0,803	• • •	1		
	27722	3 1/2"	2 1/2"	70,0	42,0	22,0	82	1,189	• • •	1		
	27724	4"	3"	74,0	42,0	22,0	97	1,398	• • •	1		

DISTRIBUTION BLOCK PLUMBING

including 1 plug and 2 fastenings

Systems: aquatherm green pipe,
aquatherm blue pipe,
aquatherm lilac pipe

Material: Fusiolen® PP-R

Colour: green

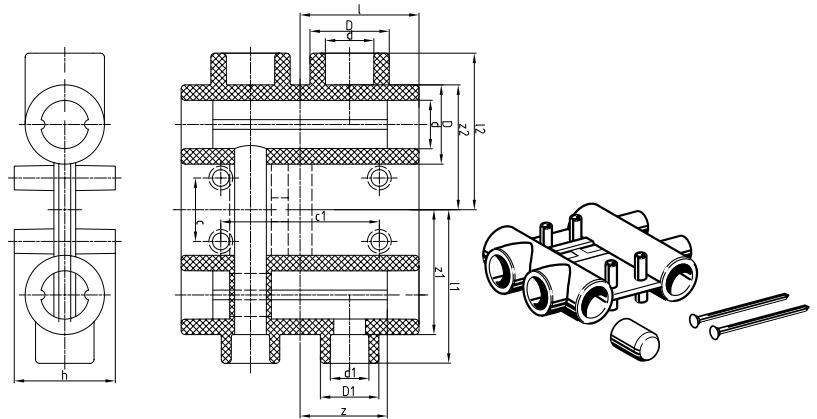

SDR	Art. no.	d [mm]	l [mm]	z [mm]	D [mm]	d1 [mm]	l1 [mm]	z1 [mm]	D1 [mm]	l2 [mm]	z2 [mm]	c [mm]	c1 [mm]	cl [mm]	l3 [mm]	h [mm]	Weight [kg]	System	PU	Box unit	Price € m/pc
6 7.4 11	30115	25	60	44	40	20	77,5	63	29,5	79	63	32	80	100	36	51	0,273	• • •	1		

FOUR-PORT MANIFOLD

length: 246 mm, with 4 branches

Systems: aquatherm green pipe,
aquatherm blue pipe,
aquatherm lilac pipe

Material: Fusiolen® PP-R

Colour: green

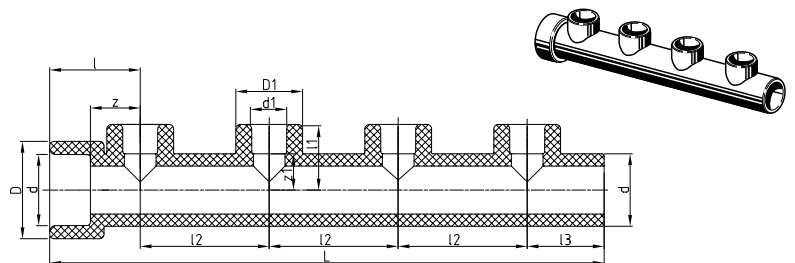

SDR	Art. no.	d [mm]	d1 [mm]	l [mm]	z [mm]	D [mm]	l1 [mm]	z1 [mm]	D1 [mm]	l2 [mm]	l3 [mm]	L [mm]	Weight [kg]	System	PU	Box unit	Price € m/pc
6 7.4	30602	32	16	40	22	43	29	16	29,5	57	36	245	0,148	•	1		
9 11	30604	32	20	40	22	43	29	14,5	29,5	57	36	245	0,134	• • •	1		

The four-port manifold can be shortened or extended by fusion with further four-port manifolds, if required.

MANIFOLD END PIECE WITH FEMALE THREAD*

Systems: aquatherm green pipe,
aquatherm blue pipe,
aquatherm lilac pipe

Material: Fusiolen® PP-R, brass

Standard: DIN 16962, DIN EN ISO 15874

Colour: green

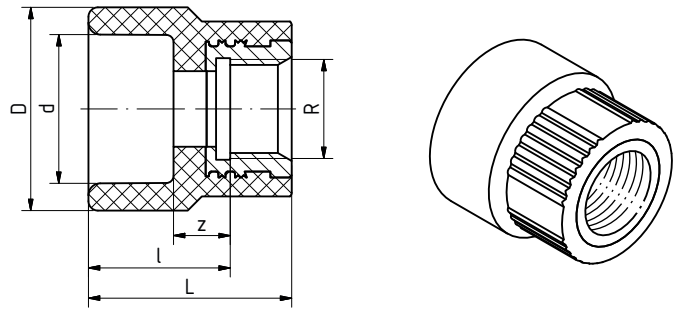

SDR	Art. no.	d [mm]	R	l [mm]	z [mm]	D [mm]	L [mm]	Weight [kg]	System	PU	Box unit	Price € m/pc
6 7.4 9 11	30804	32	1/2"	30,0	12,0	43,0	43,0	0,073	• • •	1		

* transition piece as manifold endpiece with female thread

BALL VALVE FOR MANIFOLD

female/male

Systems: aquatherm green pipe,
aquatherm blue pipe,
aquatherm lilac pipe

Material: Fusiolen® PP-R, brass

Colour: green

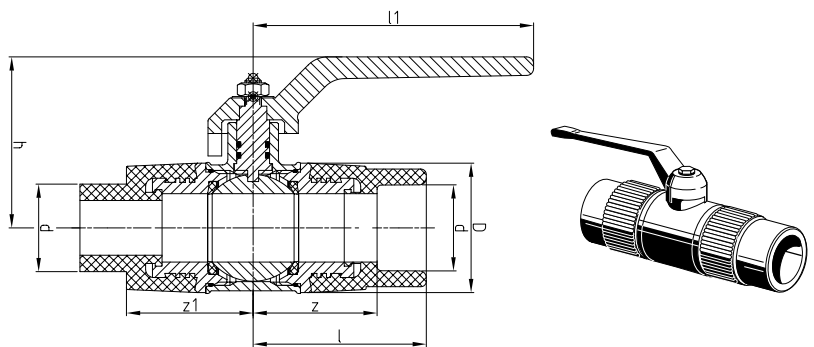

SDR	Art. no.	d [mm]	l [mm]	z [mm]	D [mm]	z1 [mm]	h [mm]	l1 [mm]	Weight [kg]	System	PU	Box unit	Price € m/pc
6 7.4 9 11	78000	32	63,0	45,0	47,5	46,5	78,0	108,0	0,575	• • •	2		

SUPPORTING STRAP FOR FOUR-PORT MANIFOLD

with clamps, galvanized, double

Systems: aquatherm green pipe,
aquatherm blue pipe,
aquatherm lilac pipe

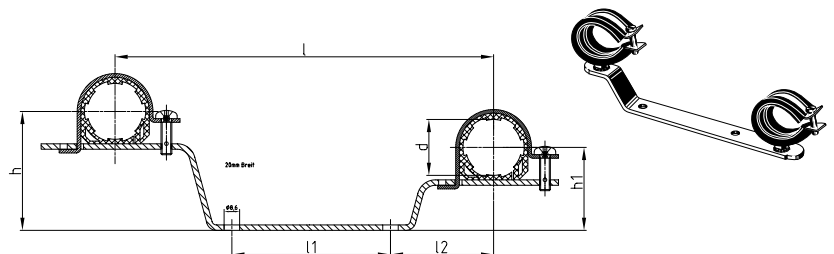

Art. no.	d [mm]	l [mm]	l1 [mm]	l2 [mm]	h [mm]	h1 [mm]	Weight [kg]	System	PU	Box unit	Price € m/pc
60210	32	210,0	80,0	57,0	66,0	46,0	0,226	• • •	2		

GLOBE VALVE*for surface installation*

Systems: aquatherm green pipe,
aquatherm blue pipe,
aquatherm lilac pipe

Material: Fusiolen® PP-R, brass

Colour: green

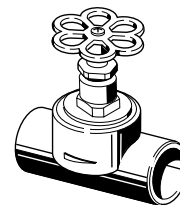
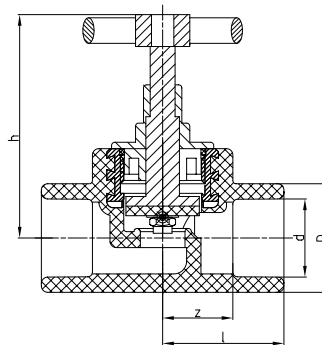

SDR	Art. no.	d [mm]	l [mm]	z [mm]	D [mm]	h [mm]	Weight [kg]	System	PU	Box unit	Price € m/pc
6	40808	20	35,0	20,5	29,5	75,3	0,165	• • •	1	100	
7.4	40810	25	38,0	22,0	34,0	75,0	0,172	• • •	1	100	
9	40812	32	49,0	31,0	43,0	97,0	0,314	• • •	1	60	
11	40814	40	60,0	39,5	52,0	111,5	0,585	• • •	1		

CONCEALED VALVE*chromium plated*

Systems: aquatherm green pipe,
aquatherm blue pipe,
aquatherm lilac pipe

Material: Fusiolen® PP-R, brass

Colour: green

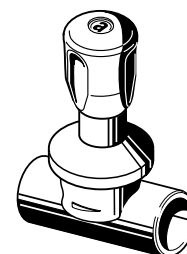
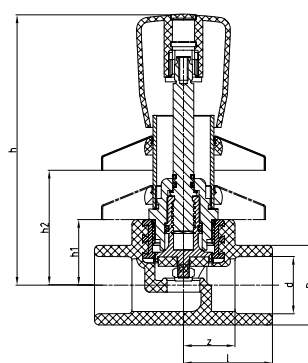

SDR	Art. no.	d [mm]	l [mm]	z [mm]	D [mm]	h [mm]	h1 [mm]	h2 [mm]	Weight [kg]	System	PU	Box unit	Price € m/pc
6	40858	20	35,0	20,5	29,5	116,0	28,0	59,0	0,319	• • •	1		
7.4	40860	25	38,0	22,0	34,0	116,0	28,0	59,0	0,330	• • •	1		
9	40862	32	49,0	31,0	43,0	121,0	34,0	59,0	0,416	• • •	1		

EXTENSION FOR CONCEALED VALVE*chromium-plated for Art. no. 40858-40862*

Systems: aquatherm green pipe,
aquatherm blue pipe,
aquatherm lilac pipe

Material: brass

Colour: chrom

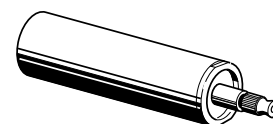
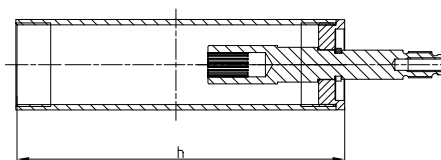

Art. no.	h [mm]	Weight [kg]	System	PU	Box unit	Price € m/pc
40900	92,0	0,148	• • •	1		
40902	132,0	0,209	• • •	1		

CONCEALED VALVE

tamper proof/chromium-plated/short design

Systems: aquatherm green pipe,
aquatherm blue pipe,
aquatherm lilac pipe

Material: Fusiolen® PP-R, brass

Colour: green, chrom

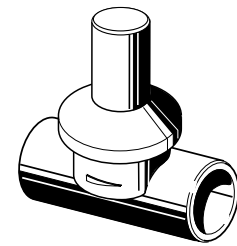
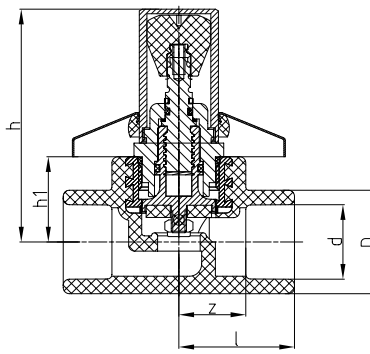

SDR	Art. no.	d [mm]	l [mm]	z [mm]	D [mm]	h [mm]	h1 [mm]	Weight [kg]	System	PU	Box unit	Price € m/pc
6	40868	20	35,0	20,5	29,5	71,5	28,0	0,258	• • •	1		
7.4	40870	25	38,0	22,0	34,0	72,0	28,0	0,288	• • •	1		
9												
11	40872	32	49,0	31,0	43,0	82,5	34,0	0,376	• • •	1		

CONCEALED VALVE

suitable for construction depth of 55 mm to 100 mm

Systems: aquatherm green pipe,
aquatherm blue pipe,
aquatherm lilac pipe

Material: Fusiolen® PP-R, brass

Colour: green, chrom

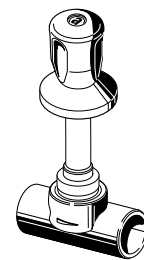
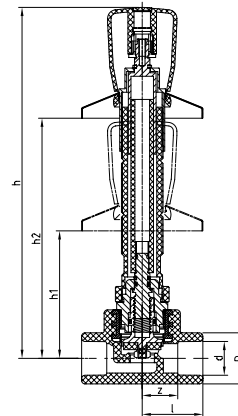

SDR	Art. no.	d [mm]	l [mm]	z [mm]	D [mm]	h [mm]	h1 [mm]	h2 [mm]	Weight [kg]	System	PU	Box unit	Price € m/pc
6	40878	20	35,0	20,5	29,5	213,0	59,0	147,0	0,357	• • •	1		
7.4	40880	25	38,0	22,0	34,0	213,0	59,0	147,0	0,369	• • •	1		
9													
11	40882	32	49,0	31,0	43,0	219,0	65,0	153,0	0,455	• • •	1		

CONCEALED VALVE

tamper proof, chromium-plated

Systems: aquatherm green pipe,
aquatherm blue pipe,
aquatherm lilac pipe

Material: Fusiolen® PP-R, brass

Colour: green, chrom

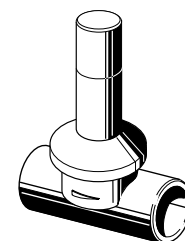
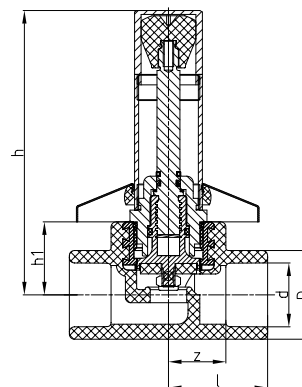

SDR	Art. no.	d [mm]	l [mm]	z [mm]	D [mm]	h [mm]	h1 [mm]	Weight [kg]	System	PU	Box unit	Price € m/pc
6	40888	20	35,0	20,5	29,5	109,0	28,0	0,342	• • •	1		
7.4	40890	25	38,0	22,0	34,0	109,0	28,0	0,350	• • •	1		
9												
11	40892	32	49,0	31,0	43,0	115,0	34,0	0,432	• • •	1		

STOP VALVE BODY

Systems: aquatherm green pipe,
aquatherm blue pipe,
aquatherm lilac pipe

Material: Fusiolen® PP-R, brass

Colour: green

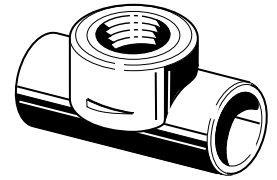
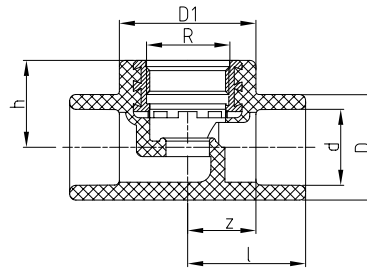

SDR	Art. no.	d [mm]	R	l [mm]	z [mm]	D [mm]	h [mm]	D1 [mm]	Weight [kg]	System	PU	Box unit	Price € m/pc
6	40908	20	3/4"	35,0	20,0	29,5	28,0	44,0	0,093	• • •	1		
7.4	40910	25	3/4"	38,0	22,0	34,0	28,0	44,0	0,101	• • •	1		
9	40912	32	1"	49,0	31,0	43,0	34,0	52,0	0,146	• • •	1		
11	40914	40	1 1/4"	60,0	39,5	52,0	41,0	69,0	0,313	• • •	1		

INCLINED VALVE

without drain

Systems: aquatherm green pipe,
aquatherm blue pipe,
aquatherm lilac pipe

Material: Fusiolen® PP-R, brass

Colour: green

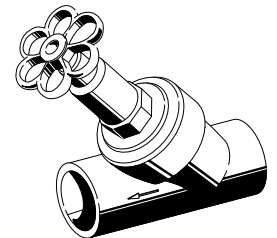
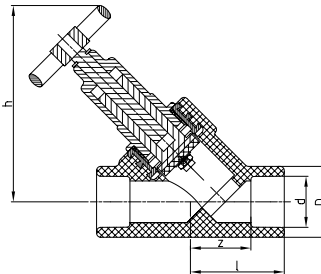

SDR	Art. no.	d [mm]	l [mm]	z [mm]	D [mm]	h [mm]	Weight [kg]	System	PU	Box unit	Price € m/pc
6	41108	20	45,0	30,5	34,0	95,5	0,294	• • •	1		
7.4	41110	25	45,0	29,0	34,0	95,5	0,283	• • •	1		
9	41112	32	56,0	38,0	43,0	111,5	0,421	• • •	1		
11	41114	40	65,0	44,5	52,0	135,0	0,834	• • •	1		

NON-RETURN VALVE

without drain

Systems: aquatherm green pipe,
aquatherm blue pipe,
aquatherm lilac pipe

Material: Fusiolen® PP-R, brass

Colour: green

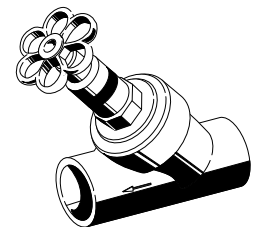
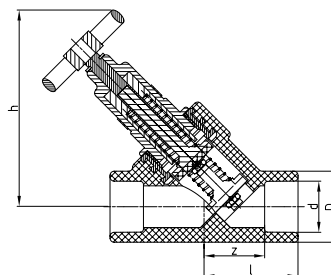

SDR	Art. no.	d [mm]	l [mm]	z [mm]	D [mm]	h [mm]	Weight [kg]	System	PU	Box unit	Price € m/pc
6	41208	20	45,0	30,5	34,0	95,5	0,297	• • •	1		
7.4	41210	25	45,0	29,0	34,0	95,5	0,292	• • •	1		
9	41212	32	56,0	38,0	43,0	111,5	0,432	• • •	1		
11	41214	40	65,0	44,5	52,0	135,0	0,840	• • •	1		

BALL VALVE PP/BRASS

Systems: aquatherm green pipe,
aquatherm blue pipe,
aquatherm lilac pipe

Material: Fusiolen® PP-R, brass

Colour: green

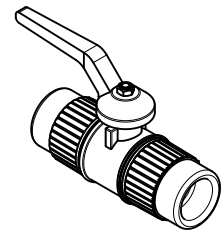
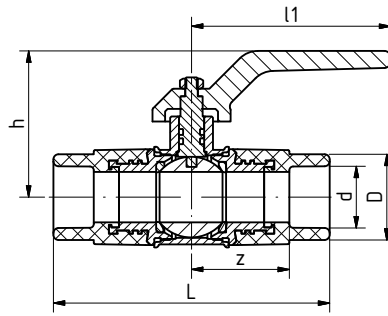

SDR	Art. no.	d [mm]	L [mm]	z [mm]	D [mm]	h [mm]	l1 [mm]	Weight [kg]	System	PU	Box unit	Price € m/pc
6 7.4 9 11	41308	20	110,00	40,50	29,50	56,00	79,00	0,280	• • •	1		
	41310	25	110,00	39,00	34,00	58,00	79,00	0,375	• • •	1		
	41312	32	127,00	45,50	43,00	66,00	103,00	0,592	• • •	1		
	41314	40	145,00	52,00	52,00	71,00	104,00	1,015	• • •	1		
	41316	50	167,00	60,00	68,00	79,00	140,00	1,689	• • •	1		
	41318	63	205,00	75,00	84,00	88,00	140,00	2,874	• • •	1		

EXTENSION FOR AQUATHERM GREEN PIPE BALL VALVE

chromium-plated for Art. no. 41308–41318

Systems: aquatherm green pipe,
aquatherm blue pipe,
aquatherm lilac pipe

Material: brass

Colour: chrom

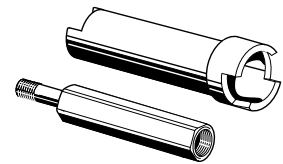
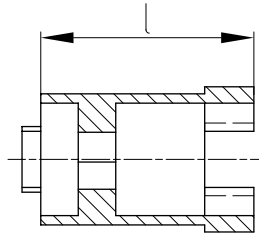

Art. no.	l [mm]	for Art. no.	Weight [kg]	System	PU	Box unit	Price € m/pc
41378	35,0	41308-41310	0,120	• • •	1		
41382	35,0	41312-41314	0,120	• • •	1		
41386	46,0	41316-41318	0,273	• • •	1		

PP-BALL VALVE

with union nut and welding socket

Systems: aquatherm green pipe,
aquatherm blue pipe,
aquatherm lilac pipe

Material: Fusiolen® PP-R

Colour: green

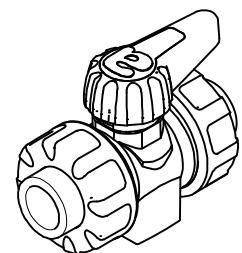
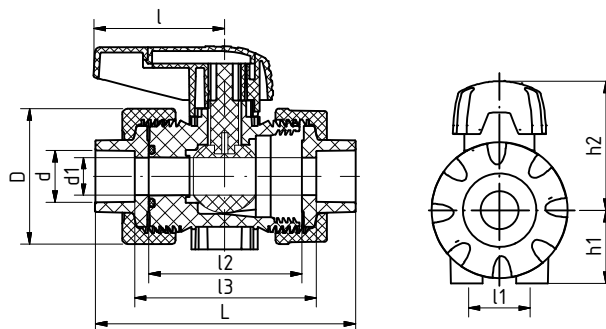

SDR	Art. no.	d [mm]	d1 [mm]	D [mm]	h1 [mm]	h2 [mm]	l1 [mm]	l2 [mm]	l3 [mm]	L [mm]	l [mm]	Weight [kg]	System	PU	Box unit	Price € m/pc
6 7.4 9 11	41488	20	13,5	50,3	27,0	48,0	25,0	56,5	68,0	97,0	48,0	0,118	• • •	1		
	41490	25	18,5	59,0	30,0	56,5	25,0	65,5	78,0	110,0	59,0	0,184	• • •	1		
	41492	32	23,9	70,3	40,0	64,5	26,0	72,0	84,5	120,5	59,0	0,274	• • •	1		
	41494	40	31,0	85,9	46,0	83,3	45,0	85,0	100,0	141,0	63,5	0,483	• • •	1		
	41496	50	38,5	99,5	55,0	89,4	45,0	89,0	107,0	154,0	63,5	0,648	• • •	1		
	41498	63	50,0	125,5	70,0	115,0	45,0	101,0	118,0	173,0	108,0	1,206	• • •	1		

ELECTRICAL DRIVE FOR BALL VALVE

incl. fixtures

For Art. no. 41488–41498

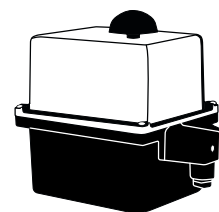

Systems: aquatherm green pipe,
aquatherm blue pipe,
aquatherm lilac pipe

Art. no.	Dimension [mm]	for Art. no.	Weight [kg]	System	PU	Box unit	Price € m/pc
230 Volt							
41489	20	incl. fixtures for 41488	1,500	• • •	1		
41491	25	incl. fixtures for 41490	1,600	• • •	1		
41493	32	incl. fixtures for 41492	1,600	• • •	1		
41495	40	incl. fixtures for 41494	1,600	• • •	1		
41497	50	incl. fixtures for 41496	1,700	• • •	1		
41499	63	incl. fixtures for 41498	1,700	• • •	1		
24 Volt							
41589	20	incl. fixtures for 41488	1,500	• • •	1		
41591	25	incl. fixtures for 41490	1,600	• • •	1		
41593	32	incl. fixtures for 41492	1,600	• • •	1		
41595	40	incl. fixtures for 41494	1,600	• • •	1		
41597	50	incl. fixtures for 41496	1,700	• • •	1		
41599	63	incl. fixtures for 41498	1,700	• • •	1		

Delivery time: on request

EXTENSION FOR BALL VALVE

For Art. no. 41488–41498

Systems: aquatherm green pipe,
aquatherm blue pipe,
aquatherm lilac pipe

Material: PVC

Colour: grey

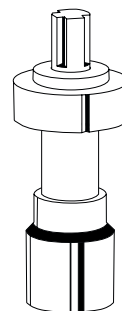

Art. no.	l [mm]	for Art. no.	Weight [kg]	System	PU	Box unit	Price € m/pc
98900	100	41488	0,020	• • •	1		
98901	100	41490/41492	0,025	• • •	1		
98902	100	41494/41496	0,030	• • •	1		
98903	100	41498	0,040	• • •	1		

Delivery time: on request

PP-BALL VALVE

with union nut and welding socket

Systems: aquatherm green pipe,
aquatherm blue pipe,
aquatherm lilac pipe

Material: Fusiolen® PP-R

Colour: green

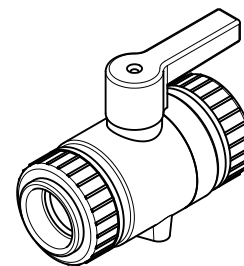
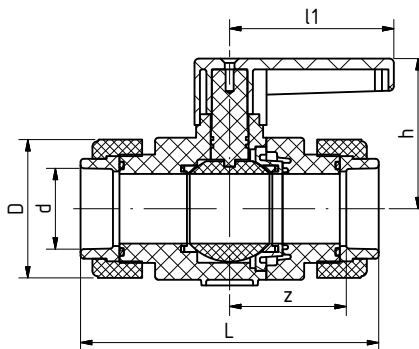

SDR	Art. no.	d [mm]	L [mm]	z [mm]	D [mm]	h [mm]	l1 [mm]	Inch R	DN	Weight [kg]	System	PU	Box unit	Price € m/pc
6 7.4 9 11	41400	75	276,0	108,0	129,0	139,0	152,0	0,00	65	2,441	• • •	1		

PP-BALL VALVE

with flange connection on both sides

Systems: aquatherm green pipe,
aquatherm blue pipe,
aquatherm lilac pipe

Material: Fusiolen® PP-R

Colour: green

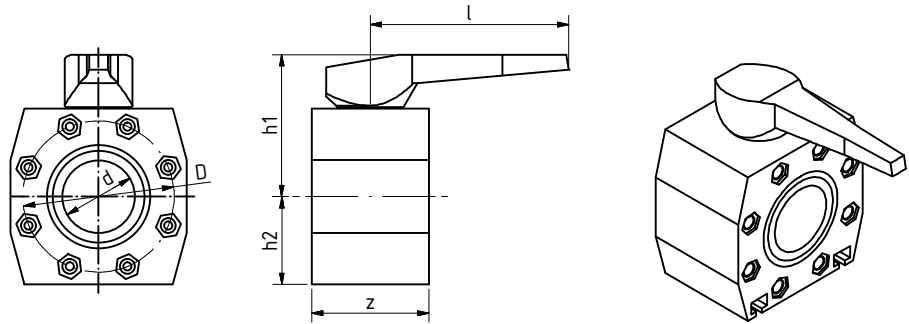

SDR	Art. no.	for \varnothing [mm]	d [mm]	l [mm]	z [mm]	D [mm]	h1 [mm]	h2 [mm]	Weight [kg]	System	PU	Box unit	Price € m/pc
6	41602	90	77,0	210,0	124,0	160,0	150,0	93,0	4,196	• • •	1		
7.4	41604	110	94,0	260,0	145,0	180,0	165,0	103,0	5,612	• • •	1		
9													
11	41607	160	135,0	310,0	205,0	240,0	210,0	136,5	13,420	• • •	1		

For dimension 125 mm the PP-ball valve Art. no. 41604 with flange adapter Art. no. 15526 and flange Art. no. 15724 is used.

For connection with aquatherm green pipe weldable flange adapter (Art. no. 15520–15531) and aquatherm green pipe plastic coated steel flange (Art. no. 15720–15730)

Hexagon screw M 16x60 mm for Art. no. 41602/41604

Hexagon screw M 20x80 mm for Art. no. 41607

corresponding flat washer M 16

NOTICE: These are not included in delivery.

ELECTRICAL DRIVE FOR BALL VALVE

incl. fixtures

For Art. no. 41602–41607

Systems: aquatherm green pipe,
aquatherm blue pipe,
aquatherm lilac pipe

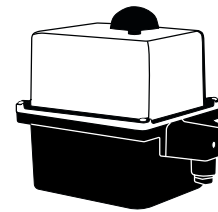

Art. no.	Dimension [mm]	for Art. no.	Weight [kg]	System	PU	Box unit	Price € m/pc
230 Volt							
41603	90	incl. fixtures for 41602	3,300	• • •	1		
41605	110	incl. fixtures for 41604	3,400	• • •	1		
41608	160	incl. fixtures for 41607	3,700	• • •	1		
24 Volt							
41703	90	incl. fixtures for 41602	3,300	• • •	1		
41705	110	incl. fixtures for 41604	3,400	• • •	1		
41708	160	incl. fixtures for 41607	3,700	• • •	1		

Delivery time: on request

EXTENSION FOR BALL VALVE

For Art. no. 41602–41607

Systems: aquatherm green pipe,
aquatherm blue pipe,
aquatherm lilac pipe

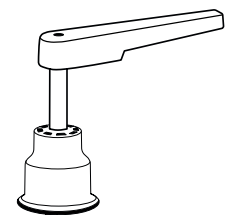

Art. no.	l [mm]	for Art. no.	Weight [kg]	System	PU	Box unit	Price € m/pc
98904	150	41602	0,788	• • •	1		
98905	150	41604	1,120	• • •	1		
98906	150	41607	1,391	• • •	1		

Delivery time: on request

aquatherm blue pipe SHUT-OFF VALVE WITH LEVER

Set consists of: 2 x flange adapter, 2 x flanges, fixing screws

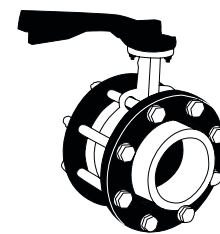
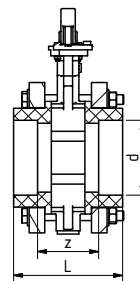
Systems: aquatherm blue pipe**Material:** Fusiolen® PP-R, Steel

SDR	Art. no.	d [mm]	z [mm]	L [mm]	Weight [kg]	System	PU	Box unit	Price € m/pc
<i>socket welding</i>									
6	2041820	75	78	138	6,763	•	1		
7.4									
9	2041822	90	80	146	9,134	•	1		
11	2041824	110	89	163	10,400	•	1		
17.6									
	2041826	125	104	184	15,600	•	1		

aquatherm blue pipe SHUT-OFF VALVE WITH LEVER

Set consists of: 2 x flange adapter, 2 x flanges, fixing screws

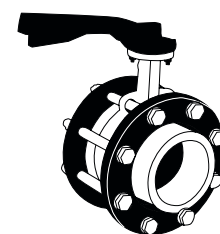
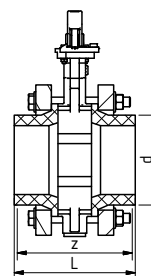
Systems: aquatherm blue pipe**Material:** Fusiolen® PP-R, Steel

SDR	Art. no.	d [mm]	z [mm]	L [mm]	Weight [kg]	System	PU	Box unit	Price € m/pc
<i>Butt welding</i>									
11	2041830	160	227	242	22,000	•	1		
17.6	2541830	160	227	242	21,700	•	1		

aquatherm blue pipe SHUT-OFF VALVE WITH DRIVE

Set consists of: 2 x flange adapter, 2 x flanges, fixing screws

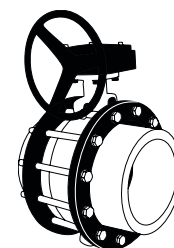
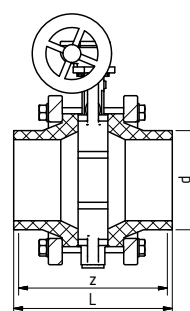
Systems: aquatherm blue pipe**Material:** Fusiolen® PP-R, Steel

SDR	Art. no.	d [mm]	z [mm]	L [mm]	Weight [kg]	System	PU	Box unit	Price € m/pc
11	2041834	200	305	320	41,400	•	1		
	2041838	250	313	328	59,200	•	1		
	2041842	315	412	432	81,800	•	1		
17.6	2541834	200	305	320	40,900	•	1		
	2541838	250	313	328	58,400	•	1		
	2541842	315	412	432	78,600	•	1		

aquatherm blue pipe NON-RETURN VALVE

Set consists of: 2 x flange adapter + seal, 2 x flanges, fixing screws

Systems: aquatherm blue pipe

Material: Fusiolen® PP-R, Steel

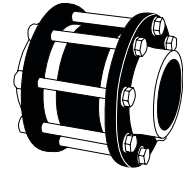
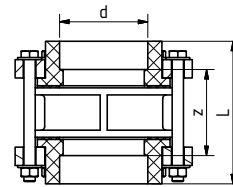

SDR	Art. no.	d [mm]	z [mm]	L [mm]	Weight [kg]	System	PU	Box unit	Price € m/pc
<i>socket welding</i>									
6	2041920	75	92	152	6,200	•	1		
7.4	2041922	90	97	163	8,800	•	1		
9	2041924	110	107	181	11,000	•	1		
11	2041926	125	124	204	15,600	•	1		
17.6									

aquatherm blue pipe NON-RETURN VALVE

Set consists of: 2 x flange adapter + seal, 2 x flanges, fixing screws

Systems: aquatherm blue pipe

Material: Fusiolen® PP-R, Steel

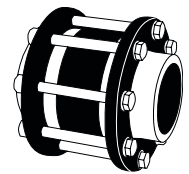
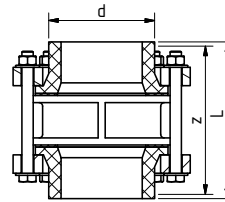

SDR	Art. no.	d [mm]	z [mm]	L [mm]	Weight [kg]	System	PU	Box unit	Price € m/pc
<i>Butt welding</i>									
	2041930	160	253	268	24,200	•	1		
11	2041934	200	352	367	37,000	•	1		
	2041938	250	365	380	58,600	•	1		
	2041942	315	476	496	83,400	•	1		
	2541930	160	253	268	23,900	•	1		
17.6	2541934	200	352	367	36,500	•	1		
	2541938	250	365	380	57,800	•	1		
	2541942	315	476	496	80,200	•	1		

DRAINING BRANCH

to weld in aquatherm green pipe valves

Systems: aquatherm green pipe,
aquatherm blue pipe,
aquatherm lilac pipe

Material: Fusiolen® PP-R, brass

Colour: green

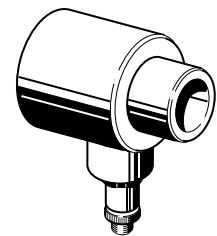
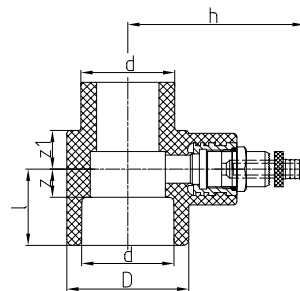

SDR	Art. no.	d [mm]	z [mm]	l [mm]	D [mm]	z1 [mm]	h [mm]	Weight [kg]	System	PU	Box unit	Price € m/pc
	41408	20	11,5	26,0	34,0	16,5	71,0	0,098	• • •	1		
	41410	25	10,0	26,0	34,0	16,5	71,0	0,096	• • •	1		
6	41412	32	14,0	32,0	43,0	17,0	74,5	0,118	• • •	1		
7.4	41414	40	12,0	32,5	52,0	16,5	80,5	0,140	• • •	1		
9	41416	50	15,5	39,0	68,0	17,0	88,0	0,202	• • •	1		
11	41418	63	16,5	44,0	84,0	16,5	96,0	0,288	• • •	1		

Important: Do not cut the aquatherm pipes with customary hack saws.
aquatherm pipes can be cut with customary saws equipped with saw blades suitable for plastic.

PIPE CUTTER

Art. no.	for pipe dimensions	PU	Box unit	Price € m/pc
50102	16-40mm	1		
50105	50-125mm	1		
50106	63-200mm	1		

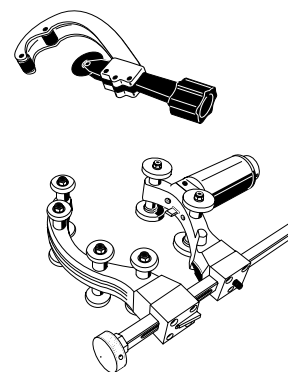

PIPE CUTTER

Art. no.	for pipe dimensions	PU	Box unit	Price € m/pc
50104	16-40mm	1		

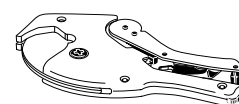

ORBITAL CIRCULAR SAW

Art. no.	for pipe dimensions	PU	Box unit	Price € m/pc
50108	160-355mm	1		

This orbital circular saw can be ordered directly from Rothenberger with Art. no. 55620 (www.rothenberger.com).
High-performance orbital circular saw for fast, precise, perfectly aligned and right-angled cutting of plastic pipes 160–355 mm at the building site or in the workshop.

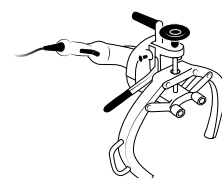

CUTTING DISC FOR PLASTIC

Art. no.	Dimension	borehole	PU	Box unit	Price € m/pc
50107	ø 125mm	22,2 mm	1		
50109	ø 230mm	22,2 mm	1		

Application: for each angle grinder
Design: diamant galvanized cutting disc

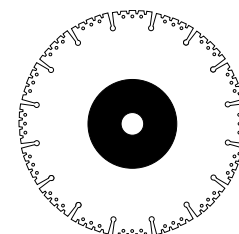

MANUAL WELDING DEVICE (500 W)

Art. no.	for pipe dimensions	PU	Box unit	Price € m/pc
50336	ø 16-32mm	1		

for one tool, with base and case for tools
Also available: 110 V (Art. no. 450336)

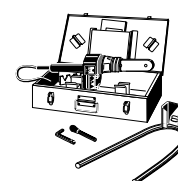

MANUAL WELDING DEVICE (800 W)

Art. no.	for pipe dimensions	PU	Box unit	Price € m/pc
50337	ø 16-63mm	1		

Also available: 110 V (Art. no. 450337)

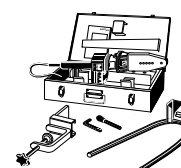

MANUAL WELDING DEVICE (1400 W)

Art. no.	for pipe dimensions	PU	Box unit	Price € m/pc
50341	ø 50-125mm	1		

Also available: 110 V (Art. no. 450341)

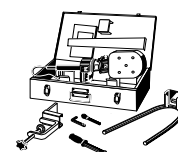

WELDING MACHINE (1400 W)

Art. no.	for pipe dimensions	PU	Box unit	Price € m/pc
50148	ø 50-125 mm - 230 V	1		

including welding tools 50–125 mm, roll stand and wooden transport case
Also available: 110 V (Art. no. 450148)

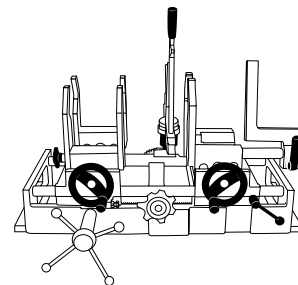

WELDING MACHINE (1400 W) LIGHT

Art. no.	for pipe dimensions	PU	Box unit	Price € m/pc
50145	ø 63-125mm	1		

including manual welding device (1400 W) and wooden transport case
Also available: 110 V (Art. no. 450145)

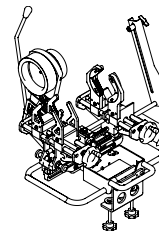

ELECTRIC WELDING JIG

Art. no.	for pipe dimensions	Weight [kg]	PU	Box unit	Price € m/pc
50159	ø 63-125mm	24,000	1		

including standby accumulator, charging station and metal case
Also available: 110 V (Art. no. 450159)

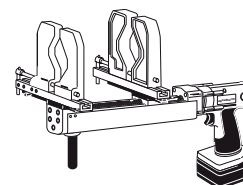

BASE FOR ART. NO. 50159

Art. no.	Dimension	PU	Box unit	Price € m/pc
50151		1		

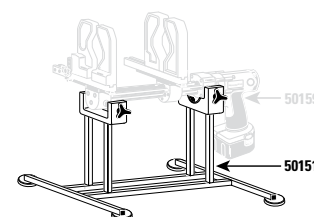

BUTT-WELDING MACHINE-TWO-RING-MACHINE WIDOS

Art. no.	Dimension [mm]	Weight [kg]	PU	Box unit	Price € m/pc
50350*	ø 160 - 250	154,000	1		
50351*	ø 160 - 315	178,000	1		

The butt-welding-two-ring machine can be purchased directly from Widos (www.widos.de)

Two-ring machine for pipes 160–355 mm available on request

* Also available in design with 110 volt (Art. no. 450350 = ø 160–250 mm / 450351 = ø 160–315 mm)

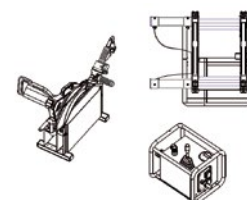

BUTT WELDING MACHINE WIDOS

Art. no.	Dimension	Weight [kg]	PU	Box unit	Price € m/pc
50352*	ø 160-250mm	195,000	1		
50353*	ø 160-315mm	250,000	1		
50354*	ø 160-355mm	425,000	1		
50355*	ø 200-450mm	430,000	1		
50356**	ø 200-500mm	500,000	1		
50357**	ø 315-630mm	885,000	1		

The butt-welding-machine can be purchased directly from Widos (www.widos.de)

* Also available in design with 110 volt (Art. no. 450352 = ø 160–250 mm / 450353 = ø 160–315 mm / 450354 = ø 160–355 mm / 450355 = ø 200–450 mm)

** special voltage on demand

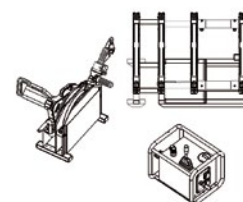

MANUAL WELDING DEVICE (1500 W) FOR SADDLE WELDING Ø 50–160 MM

Art. no.	for pipe dimensions	PU	Box unit	Price € m/pc
50330	ø 50-160mm	1		

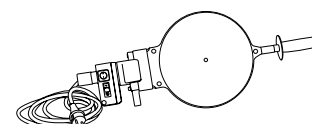

BUTT WELDING MACHINE RITMO

Art. no.	for pipe dimensions	Weight [kg]	PU	Box unit	Price € m/pc
50165*	ø 160-250mm	176,500	1		
50166*	ø 160-315mm	160,000	1		
50177	ø 160-355mm	336,500	1		
50169	ø 400-630mm	710,000	1		

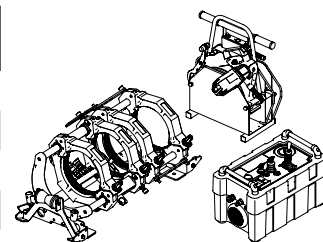

including wooden transport box. The butt welding machine can be obtained directly from Ritmo (www.ritmo.it)

* Also available: 110 V (Art. no. 450165 for ø 160–250 mm / Art. no. 450166 for ø 160–315 mm)

Two-ring machine for pipes 160–355 mm available on request

ELECTROFUSION DEVICE

Art. no.	for pipe dimensions	PU	Box unit	Price € m/pc
50175	ø 20-250mm	1		

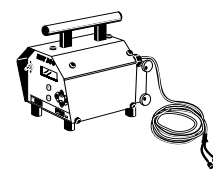

For processing with electro-fusion-sockets Art. no. 17208–17238.

Special calibration-tools – obtainable on request – are required

TEMPERATURE PENCIL

Art. no.	Dimension	PU	Box unit	Price € m/pc
50190		1		

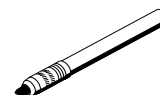

to check the correct welding temperature

SURFACE THERMOMETER

Art. no.	Dimension	PU	Box unit	Price € m/pc
50188		1		



to check the correct welding temperature

TEMPERATURE PREDECTIVE GLOVE

for tool change

Art. no.	Dimension	PU	Box unit	Price € m/pc
50195		2		



CLEANING WIPES

Art. no.	Dimension	PU	Box unit	Price € m/pc
50193	Box/100 towels	1		

for electrofusion sockets



WELDING TOOLS

Art. no.	Dimension [mm]	PU	Box unit	Price € m/pc
50206	16	1		
50208	20	1		
50210	25	1		
50212	32	1		
50214	40	1		
50216	50	1		
50218	63	1		
50220	75	1		
50222	90	1		
50224	110	1		
50226	125	1		

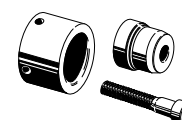

REPAIR SET

Art. no.	Dimension	PU	Box unit	Price € m/pc
50307	7mm	1		
50311	11mm	1		

to close holes of up to 10 mm in the pipe (pipe repair stick Art. no. 60600)



PIPE REPAIR STICK

for pipe repairs

Art. no.	Dimension	PU	Box unit	Price € m/pc
60600	7/11mm	10		



aquatherm UNIVERSAL PEELING TOOLS

for aquatherm green pipe MF UV, aquatherm green pipe MF RP UV, aquatherm blue pipe MF UV and aquatherm blue pipe MF OT



Required for the socket welding

(in combination with socket welding fittings from page 122 onwards, e.g. sockets, elbows, T-pieces, transition pieces with thread)

Also suitable for manual peeling (bolts included)

Art. no.	Dimension [mm]	PU	Box unit	Price € m/pc
50479	20	1		
50480	25	1		
50481	32	1		
50482	40	1		
50483	50	1		
50484	63	1		
50485	75	1		
50486	90	1		
50487	110	1		
50488	125	1		
50501	Spare blade with screw	1		

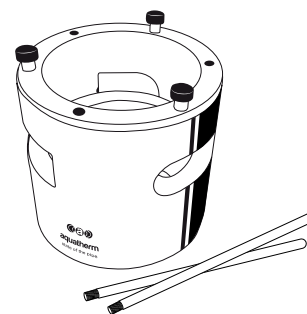

incl. bolts
for manual peeling

not suitable for aquatherm green pipe S, aquatherm blue pipe S, aquatherm green pipe MF, aquatherm blue pipe MF, aquatherm green pipe MF RP, aquatherm green pipe TI, aquatherm blue pipe TI

S = single, **MF** = multilayer fibre, **OT** = oxygen tight, **UV** = ultraviolet protected, **TI** = thermal insulation, **RP** = raised pressure

aquatherm EXTENSION FOR UNIVERSAL PEELING TOOL

Required for the electrofusion socket welding
(aquatherm electrofusion sockets on page 149)

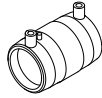

When electrofusion welding a longer welding depth is required, which is achieved by the combination of the universal peeling tool and the extension for the universal peeling tool (e.g. Art. no. 50479+50489)

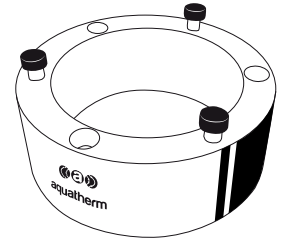

Art. no.	Dimension	PU	Box unit	Price € m/pc
50489	for peeling tool 20 mm Art. no. 50479	1		
50490	for peeling tool 25 mm Art. no. 50480	1		
50491	for peeling tool 32 mm Art. no. 50481	1		
50492	for peeling tool 40 mm Art. no. 50482	1		
50493	for peeling tool 50 mm Art. no. 50483	1		
50494	for peeling tool 63 mm Art. no. 50484	1		
50495	for peeling tool 75 mm Art. no. 50485	1		
50496	for peeling tool 90 mm Art. no. 50486	1		
50497	for peeling tool 110 mm Art. no. 50487	1		
50498	for peeling tool 125 mm Art. no. 50488	1		

ATTACHMENT PLATE FOR UNIVERSAL PEELING TOOL

In combination with or without extension for universal peeling tools for drilling machine

Art. no.	Dimension	PU	Box unit	Price € m/pc
50499	for universal peeling tool 50479 – 50484	1		
50500	for universal peeling tool 50485 – 50488	1		

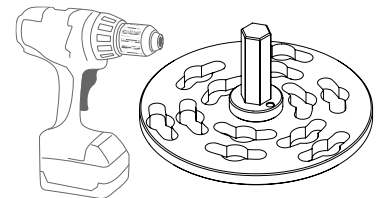

Delivery without drilling machine!

UNIVERSAL PEELING TOOL-SET

20–63 mm

Art. no.	Dimension	PU	Box unit	Price € m/pc
50477	for ø 20–63 mm	1		

consisting of:

- 1x case
- Each 1x 50479–50484 peeling tool 20–63 mm
- 1x 50499 attachment plate for universal peeling tool 50479–50484
- 1x 50503 1 toggle-set
- 1x 50504 torx wrench
- 1x 50505 hexagon Allen key size 4
- 6x 99793 6 fixing screws for Art. no. 50489–50494 M5x25



UNIVERSAL PEELING TOOL-SET

75–125 mm

Art. no.	Dimension	PU	Box unit	Price € m/pc
50478	for ø 75 - 125 mm	1		

consisting of:

- 1 x case
- Each 1x 50485–50488 peeling tool 75–125 mm
- 1x 50500 attachment plate for universal peeling tool 50485–50488
- 1x 50503 1 toggle-set
- 1x 50504 torx wrench
- 1x 50505 hexagon Allen key size 4
- 6x 99794 6 fixing screws for Art. no. 50495–50498 M5x35



MANUAL SCRAPER FOR aquatherm blue pipe OT PIPES

Art. no.	Dimension	PU	Box unit	Price € m/pc
50509	with 4-fold blade, 35 mm wide	1		

For removal of OT-coat before butt-welding.
In addition the manual scraper can be used for removal of oxid coating for the E-socket welding.

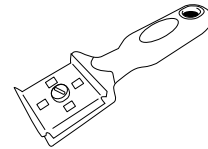

SPARE BLADE SET FOR ART. NO. 50509

Art. no.	Dimension	PU	Box unit	Price € m/pc
99909	2 pieces = 1 set	1		

CHAMFERING TOOL FOR aquatherm blue pipe OT UND UV PIPES

Art. no.	Dimension	PU	Box unit	Price € m/pc
50510	32-250mm	1		

For removal of oxid coating before butt-welding.

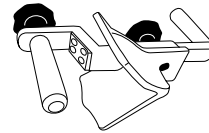

aquatherm PEELING TOOLS FOR ELECTROFUSION SOCKET WELDING (ART. NO.17208–17238)

for aquatherm green pipe S, aquatherm green pipe MF, aquatherm green pipe MF RP, aquatherm green pipe MF TI, aquatherm blue pipe S, aquatherm blue pipe MF and aquatherm blue pipe MF TI

Required to remove the **oxid coating**
(aquatherm electrofusion sockets on page 149)

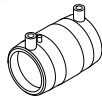

Art. no.	Dimension [mm]	PU	Box unit	Price € m/pc
<i>In combination with a drilling machine</i>				
50558	20	1		
50560	25	1		
50562	32	1		
50564	40	1		
50566	50	1		
50568	63	1		
50570	75	1		
50572	90	1		

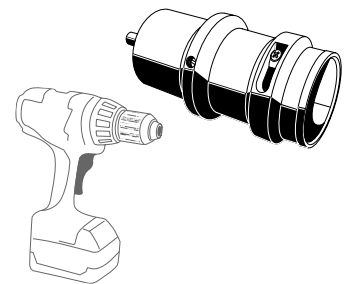

Art. no. 50558–50572

In combination with a drilling machine (not included!)

50440	spare blade	1		
-------	-------------	---	--	--

For manual peeling

50574	110	1		
50576	125	1		
50580	160	1		

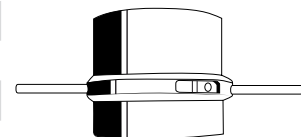

Art. no. 50574–50580

50441	spare blade	1		
-------	-------------	---	--	--

For manual peeling

50592	200 + 250	1		
99739	spare blade	1		

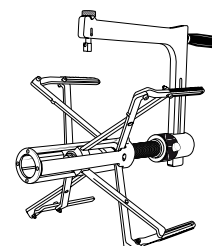

Art. no. 50592

Not suitable for aquatherm green pipe UV, aquatherm blue pipe UV and aquatherm blue pipe OT

S = single, **MF** = multilayer fibre, **OT** = oxygen tight, **UV** = ultraviolet protected, **TI** = thermal insulation, **RP** = raised pressure

Spare parts such as blades can be requested under service@aquatherm.de!

SADDLE WELDING TOOLS

for welding saddles

Art. no.	Dimension	PU	Box unit	Price € m/pc
50614	40x20/25mm	1		
50616	50x20/25mm	1		
50619	63x20/25mm	1		
50620	63x32mm	1		
50623	75x20/25mm	1		
50624	75x32mm	1		
50625	75x40mm	1		
50627	90x20/25mm	1		
50628	90x32mm	1		
50629	90x40mm	1		
50631	110x20/25mm	1		
50632	110x32mm	1		
50634	110x40mm	1		
50635	110x50mm	1		
50636	125x20/25mm	1		
50638	125x32mm	1		
50640	125x40mm	1		
50642	125x50mm	1		
50644	125x63mm	1		
50648	160x20/25mm	1		
50650	160x32mm	1		
50652	160x40mm	1		
50654	160x50mm	1		
50656	160x63mm	1		
50657	160x75mm	1		
50658	160x90mm	1		
50660	200x20/25mm	1		
50662	200x32mm	1		
50664	200x40mm	1		
50666	200x50mm	1		
50667	200x75mm	1		
50668	200x63mm	1		
50669	200x90mm	1		
50670	200x110mm	1		
50671	200x125mm	1		
50672	250x20/25mm	1		
50674	250x32mm	1		
50676	250x40mm	1		
50678	250x50mm	1		
50680	250x63mm	1		
50682	250x75mm	1		

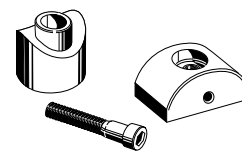

SADDLE WELDING TOOLS

for welding saddles

Art. no.	Dimension	PU	Box unit	Price € m/pc
50684	250x90mm	1		
50686	250x110mm	1		
50688	250x125mm	1		
50690	315x63mm	1		
50692	315x75mm	1		
50694	315x90mm	1		
50696	315x110mm	1		
50698	315x125mm	1		
50699	315x160mm	1		
50712	355x63mm	1		
50714	355x75mm	1		
50716	355x90mm	1		
50718	355x110mm	1		
50720	355x125mm	1		
50722	355x160mm	1		
50726	400-630x63mm	1		
50728	400-500x75mm	1		
50730	560-630x75mm	1		
50732	400-500x90mm	1		
50734	560-630x90mm	1		
50736	400-450x110mm	1		
50738	500-560x110mm	1		
50740	630x110mm	1		
50742	400x125mm	1		
50744	450-500x125mm	1		
50746	560-630x125mm	1		

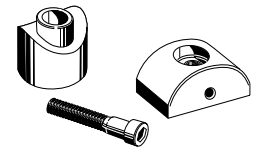

SADDLE PEELING TOOLS FOR OT UND UV PIPES Ø 50–125 mm

Art. no.	Dimension	PU	Box unit	Price € m/pc
50921	for welding saddles 20 & 25 mm	1		
50922	for ø 32 mm	1		
50924	for ø 40 mm	1		
50926	for ø 50 mm	1		
50928	for ø 63 mm	1		

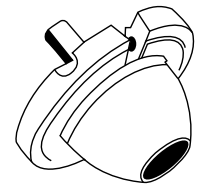

SADDLE PEELING TOOLS FOR OT UND UV PIPES Ø 160–250 mm

Art. no.	Dimension	PU	Box unit	Price € m/pc
50421	for welding saddles ø 20 & 25 mm	1		
50422	for welding saddles ø 32 mm	1		
50424	for welding saddles ø 40 mm	1		
50426	for welding saddles ø 50 mm	1		
50428	for welding saddles ø 63 mm	1		

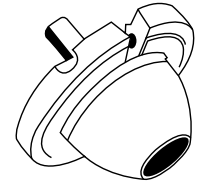

DRILLS for installation of weld-in saddles

Art. no.	Dimension	PU	Box unit	Price € m/pc
50940	20&25mm (40-160mm)	1		
50941	20&25mm (63-250mm)	1		
50942	32mm	1		
50944	40mm	1		
50946*	50mm	1		
50948*	63mm	1		

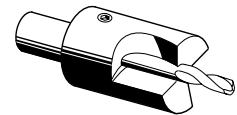

* may only be used in fixed drilling machines!

DRILL DUSS DIA303

Art. no.	Dimension	PU	Box unit	Price € m/pc
50978		1		

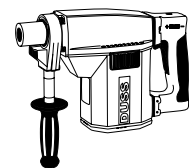

CHUCK ADAPTER FOR ART. NO. 50971

Art. no.	Dimension	PU	Box unit	Price € m/pc
50969		1		

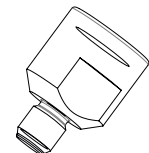

KEYLESS CHUCK clamping range 1,5–13mm

Art. no.	Dimension	PU	Box unit	Price € m/pc
50971		1		

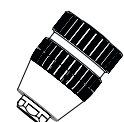

HOLE SAW HOLDER LSA3

Art. no.	Dimension	PU	Box unit	Price € m/pc
50976	1/2" for drill chuck	1		

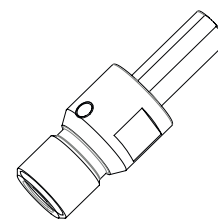

HOLE SAW HOLDER LSA2

Art. no.	Dimension	PU	Box unit	Price € m/pc
50974	1/2" for DUSS-machines	1		

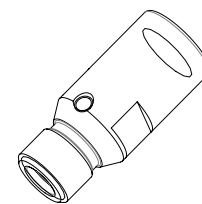

SADDLE-HOLE SAW FOR BRANCH *for assembly of weld-in saddles*

Art. no.	Dimension	PU	Box unit	Price € m/pc
50987	75mm	1		
50988	90mm	1		
50989	110mm	1		
50990	125mm	1		
50991	160mm	1		

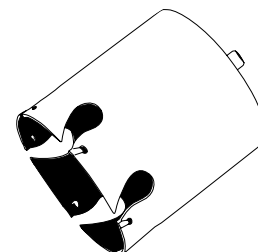

QUICK CHANGE ADAPTER 75-90MM

Art. no.	Dimension	PU	Box unit	Price € m/pc
50973	for Art. no. 50987-50988	1		

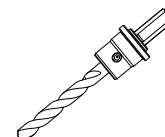

CENTER DRILL LSZ 1

Art. no.	Dimension	PU	Box unit	Price € m/pc
50975	with capture sleeve	1		



DRILL RIG FOR DUSS-DRILL

Art. no.	Dimension	PU	Box unit	Price € m/pc
50977		1		

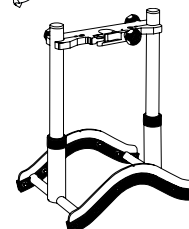

WELDING FIXTURE FOR DRILL RIG 50977

Art. no.	Dimension	PU	Box unit	Price € m/pc
50979		1		

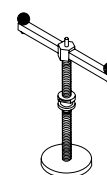

HOLE SAW SYSTEM

The diagram illustrates the Hole Saw System components and their assembly. It shows a cross-section of a hole saw assembly with labels for various parts:

- Art. no. 50969**: Drill chuck
- Art. no. 50971**: Drill bit
- Art. no. 50974**: Hole Saw Holder LSA3
- Art. no. 50976**: Hole Saw Holder LSA2
- Art. no. 50989-50991**: Saddle-Hole Saw for Branch
- Art. no. 50975**: Center Drill LSZ 1
- Art. no. 50973**: Quick Change Adapter 75-90mm
- Art. no. 50987 & 50988**: Saddle-Hole Saw for Branch (75mm and 90mm)

HOT TAPPING TOOL

for drilling of pipes under pressure

The hot tapping tool (Art. no. 50890) is used for drilling pipes for branch connections in the dimensions 40 and 63 mm.

The PP-main pipes aquatherm green pipe, blue pipe and lilac pipe with the **pipe structure S and MF UV** from 75 mm to 630 mm can be drilled under **medium pressure (water) of maximum 6 bar** and a **medium temperature of 10–60 °C**.

HOT TAPPING TOOL

for weld-on saddle set with ball valve

Art. no.	Dimension	PU	Box unit	Price € m/pc
50890	for dimension 40 + 63mm	1		



ADAPTER FOR WELD-ON SADDLE SET WITH BALL VALVE 40 MM

for installation under pressure

Art. no.	Dimension [mm]	PU	Box unit	Price € m/pc
50891	40	1		

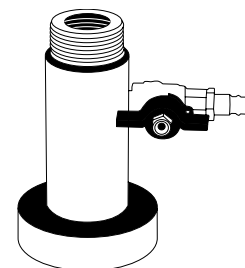

ADAPTER FOR WELD-ON SADDLE SET WITH BALL VALVE 63 MM

for installation under pressure

Art. no.	Dimension [mm]	PU	Box unit	Price € m/pc
50892	63	1		

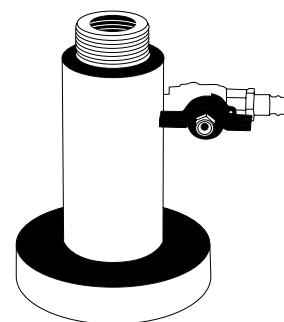

PP-MILLING CUTTER FOR WELD-ON SADDLE SET WITH BALL VALVE 40 MM

for installation under pressure

for Art. no. 50891

Art. no.	Dimension [mm]	PU	Box unit	Price € m/pc
50893	40	1		

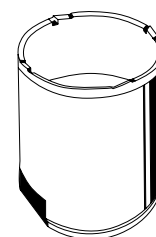

PP-MILLING CUTTER FOR WELD-ON SADDLE SET WITH BALL VALVE 63 MM

for installation under pressure

for Art. no. 50892

Art. no.	Dimension [mm]	PU	Box unit	Price € m/pc
50894	63	1		

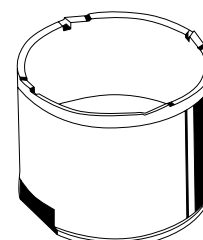

aquatherm WELD-ON SADDLE TOOL

for weld-on saddle set with ball valve for installation under pressure
for hot tapping tool Art. no. 50890

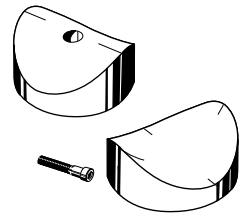

Art. no.	Dimension	PU	Box unit	Price € m/pc
50760	75x40mm	1		
50761	90x40mm	1		
50762	110x40mm	1		
50763	125x40mm	1		
50764	125x63mm	1		
50765	160x40mm	1		
50766	160x63mm	1		
50767	200x40mm	1		
50768	200x63mm	1		
50769	250x40mm	1		
50770	250x63mm	1		
50771	315x63mm	1		
50772	355x63mm	1		
50773	400-630x63mm	1		

HOT TAPPING TOOL

for drilling pipes under pressure

The hot tapping tool (Art. no. 50890) is for drilling of pipelines. PP-main pipes from 75 mm to 630 mm can be drilled under pressure.

The following accessories are required for processing:

adapter for ball valve 40 mm	Art. no. 50891
adapter for ball valve 63 mm	Art. no. 50892
PP-milling cutter 40 mm	Art. no. 50893
PP-milling cutter 63 mm	Art. no. 50894
aquatherm weld-on saddle tool	Art. no. 50760–50773
aquatherm weld-on saddle set with ball valve	Art. no. 16175–16300

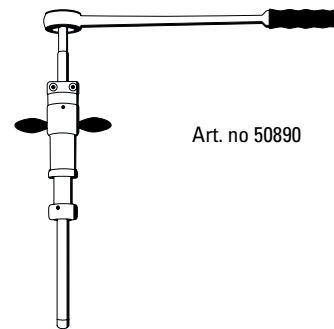

Art. no 50890

Art. no 50893



Art. no 50894



Art. no 50891

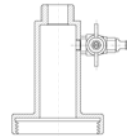

Art. no 50892

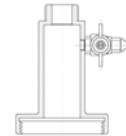

Art. no
16175
16181
16188
16196
16212
16231
16251

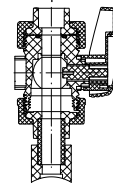

Art. no
16198
16216
16233
16253
16260
16300

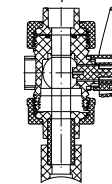

In combination with
weld-on saddle tool

Art. no
50760
50761
50762
50763
50765
50767
50769

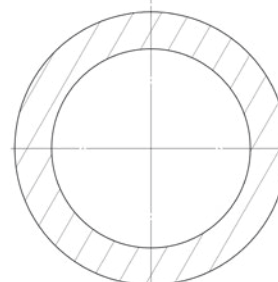

In combination with
weld-on saddle tool

Art. no
50764
50766
50768
50770
50771
50772
50773

aquatherm Prefabrication

Advantages aquatherm Prefabrication: Planning, fabrication and service

Investors

- Support from planning to commissioning
- Service technicians provide advice and support on site
- Development of customized solutions
- Time- and cost savings due to pre-fabrication
- Cost transparency
- Quick and easy installation into existing systems
- Reduce dead-time
- Over 40 years of proven quality and experience
- Insurance cover up to 20 million Euros per individual case

Architects and planners

- Planning support from the aquatherm design team
- Support for the plausibility and completeness check
- Provision of CAD and planning data
- Detailed planning data for testing and production release
- 3D drawings minimize design errors
- Early detailed planning means planning and cost reliability
- High precision of the components due to pre-fabrication
- Time saving through pre-fabrication
- Years of experience in manifold and plant construction

Advantages of aquatherm manifolds and special components

- Consistent quality by industrial prefabrication „Made in Germany“
- Certified and inspected – ISO 9001/ISO 14001/ISO 50001
- Resistance to corrosion, chemicals and aggressive media
- Pre-insulated available
- Thinner insulation
- UV-resistance available
- Heat-/sound-insulating properties
- Oxygen-tight¹
- Hygienic²
- Weight reduction due to the use of PP-R
- No silting by corrosion products
- Less pipe roughness and high abrasion resistance
- High impact strength
- Tight connection of pipe and fitting by fusion
- Three-layer pipe structure with glass fiber-reinforced middle-layer
- Flame resistant according to DIN 4102-1, building material class B 1³
- Recyclable
- Durable

Plumbers/Plant engineers

- High, tested quality with a 10 years warranty
- Support and advice of service technicians on site
- Highest accuracy due to detailed planning
- Order monitoring and delivery by the specialized wholesale
- No delays due to missing parts
- Low tooling costs
- Rapid add-on by aquatherm saddle-technique
- Weight reduction due to the use of PP-R, thus easier handling during transport and on site
- No improvise on site
- Fast installation times
- Installation in confined spaces is possible
- Compensation of skills shortage

¹ aquatherm blue pipe OT

² aquatherm green pipe

³ aquatherm red pipe



aquatherm green / blue pipe TWO-SIDED WITH FLANGE ADAPTER AND LOOSE FLANGE 5.8 M

MF = Multifaser / S = single layer pipe as single pipe in 5.8 m length

Outside diameter [mm]	aquatherm green pipe SDR 9		aquatherm green pipe SDR 11		aquatherm blue pipe SDR 11		aquatherm blue pipe ot SDR 11		aquatherm blue pipe SDR 17.6		PU m/pc
	Art. no.	Price € m/pc	Art. no.	Price € m/pc	Art. no.	Price € m/pc	Art. no.	Price € m/pc	Art. no.	Price € m/pc	
160	7270729		7310229*		8370129		8570129		8470129		5.8
200	7270733		7310233*		8370133		8570133		8470133		5.8
250	7270737		7310237*		8370137		8570137		8470137		5.8
315	7270741		7310241*		8370141				8470141		5.8
355	7270743		7310243*		8370143				8470143		5.8
400			7310245		8370145				8470145		5.8
450			7310247		8370147				8470147		5.8
500									8470149		5.8
560									8470151		5.8
630									8470153		5.8

* single layer

Flanges from 200 mm = PN 10, other flanges (PN 6 and PN 16) available on request



aquatherm green / blue pipe TWO-SIDED WITH FLANGE ADAPTER AND LOOSE FLANGE 11.6 M

MF = Multifaser / S = single layer pipe as single pipe in 11.6 m length

Outside diameter [mm]	aquatherm green pipe SDR 9		aquatherm green pipe SDR 11		aquatherm blue pipe SDR 11		aquatherm blue pipe ot SDR 11		aquatherm blue pipe SDR 17.6		PU m/pc
	Art. no.	Price € m/pc	Art. no.	Price € m/pc	Art. no.	Price € m/pc	Art. no.	Price € m/pc	Art. no.	Price € m/pc	
160	7270730		7310230*		8370130		8570130		8470130		11.6
200	7270734		7310234*		8370134		8570134		8470134		11.6
250	7270738		7310238*		8370138		8570138		8470138		11.6
315	7270742		7310242*		8370142				8470142		11.6
355	7270744		7310244*		8370144				8470144		11.6
400			7310246		8370146				8470146		11.6
450			7310248		8370148				8470148		11.6
500									8470150		11.6
560									8470152		11.6
630									8470154		11.6

* single layer



aquatherm green / blue pipe ONE-SIDED WITH FLANGE ADAPTER AND LOOSE FLANGE 5.8 M

MF = Multifaser / S = single layer pipe as single pipe in 5.8 m length

Outside diameter [mm]	aquatherm green pipe SDR 9		aquatherm green pipe SDR 11		aquatherm blue pipe SDR 11		aquatherm blue pipe ot SDR 11		aquatherm blue pipe SDR 17.6		PU m/pc
	Art. no.	Price € m/pc	Art. no.	Price € m/pc	Art. no.	Price € m/pc	Art. no.	Price € m/pc	Art. no.	Price € m/pc	
160	7270829		7310329*		8370329		8570329		8470329		5.8
200	7270833		7310333*		8370333		8570333		8470333		5.8
250	7270837		7310337*		8370337		8570337		8470337		5.8
315	7270841		7310341*		8370341				8470341		5.8
355	7270843		7310343*		8370343				8470343		5.8
400			7310345		8370345				8470345		5.8
450			7310347		8370347				8470347		5.8
500									8470349		5.8
560									8470351		5.8
630									8470353		5.8

* single layer



aquatherm green / blue pipe ONE-SIDED WITH FLANGE ADAPTER AND LOOSE FLANGE 11.6 M

MF = Multifaser / S = single layer pipe as single pipe in 11.6 m length

Outside diameter [mm]	aquatherm green pipe SDR 9		aquatherm green pipe SDR 11		aquatherm blue pipe SDR 11		aquatherm blue pipe ot SDR 11		aquatherm blue pipe SDR 17.6		PU m/pc
	Art. no.	Price € m/pc	Art. no.	Price € m/pc	Art. no.	Price € m/pc	Art. no.	Price € m/pc	Art. no.	Price € m/pc	
160	7270830		7310330*		8370330		8570330		8470330		11.6
200	7270834		7310334*		8370334		8570334		8470334		11.6
250	7270838		7310338*		8370338		8570338		8470338		11.6
315	7270842		7310342*		8370342				8470342		11.6
355	7270844		7310344*		8370344				8470344		11.6
400			7310346		8370346				8470346		11.6
450			7310348		8370348				8470348		11.6
500									8470350		11.6
560									8470352		11.6
630									8470354		11.6

* single layer

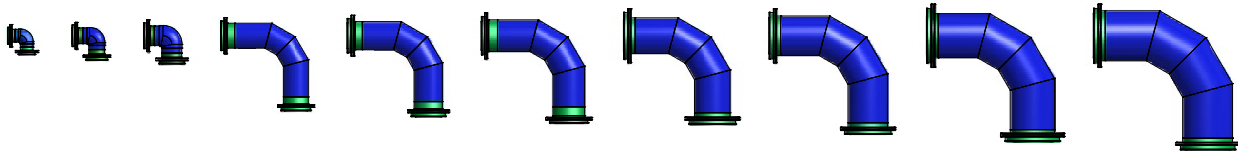

aquatherm ELBOW 90° TWO-SIDED WITH FLANGE ADAPTER AND LOOSE FLANGE

Outside diameter [mm]	aquatherm green pipe SDR 9		aquatherm green pipe SDR 11		aquatherm blue pipe SDR 11		aquatherm blue pipe ot SDR 11		aquatherm blue pipe SDR 17.6		PU pc
	Art. no.	Price € m/pc	Art. no.	Price € m/pc	Art. no.	Price € m/pc	Art. no.	Price € m/pc	Art. no.	Price € m/pc	
160	7212130		7312131		8312131		8512131		8412130		1
200	7212134		7312135		8312135		8512135		8412134		1
250	7212138		7312139		8312139		8512139		8412138		1
315	7212142		7312143		8312143				8412142		1
355	7212144		7312145		8312145				8412144		1
400			7312147		8312147				8412146		1
450			7312149		8312149				8412148		1
500									8412150		1
560									8412152		1
630									8412154		1

On demand also available in design 60° and 75°



aquatherm ti FIBER COMPOSITE PIPE **TWO-SIDED** WITH FLANGE ADAPTER AND LOOSE FLANGE **5.8 M**

Fiber composite pipe as single pipe in 5.8 m length with PUR- rigid foam insulation and PE-casing pipe.

Outside diameter		aquatherm green pipe ti SDR 9		aquatherm blue pipe ti SDR 11		aquatherm blue pipe ot ti SDR 11		aquatherm blue pipe ti SDR 17.6		PU
Medium pipe [mm]	Casing pipe [mm]	Art. no.	Price € m/pc	Art. no.	Price € m/pc	Art. no.	Price € m/pc	Art. no.	Price € m/pc	m/pc
160	250	7470729		8770129		8970129		8870129		5.8
200	315	7470733		8770133		8970133		8870133		5.8
250	400	7470737		8770137		8970137		8870137		5.8
315	450	7470741		8770141				8870141		5.8
355	500	7470743		8770143				8870143		5.8



aquatherm ti FIBER COMPOSITE PIPE **TWO-SIDED** WITH FLANGE ADAPTER AND LOOSE FLANGE **11.6 M**

Fiber composite pipe as single pipe in 11.6 m length with PUR- rigid foam insulation and PE-casing pipe.

Outside diameter		aquatherm green pipe ti SDR 9		aquatherm blue pipe ti SDR 11		aquatherm blue pipe ot ti SDR 11		aquatherm blue pipe ti SDR 17.6		PU
Medium pipe [mm]	Casing pipe [mm]	Art. no.	Price € m/pc	Art. no.	Price € m/pc	Art. no.	Price € m/pc	Art. no.	Price € m/pc	m/pc
160	250	7470730		8770130		8970130		8870130		11.6
200	315	7470734		8770134		8970134		8870134		11.6
250	400	7470738		8770138		8970138		8870138		11.6
315	450	7470742		8770142				8870142		11.6
355	500	7470744		8770144				8870144		11.6



aquatherm ti FIBER COMPOSITE PIPE **ONE-SIDED** WITH FLANGE ADAPTER AND LOOSE FLANGE **5.8 M**

Fiber composite pipe as single pipe in 5.8 m length with PUR- rigid foam insulation and PE-casing pipe.

Outside diameter		aquatherm green pipe ti SDR 9		aquatherm blue pipe ti SDR 11		aquatherm blue pipe ot ti SDR 11		aquatherm blue pipe ti SDR 17.6		PU
Medium pipe [mm]	Casing pipe [mm]	Art. no.	Price € m/pc	Art. no.	Price € m/pc	Art. no.	Price € m/pc	Art. no.	Price € m/pc	m/pc
160	250	7470829		8770329		8970329		8870329		5.8
200	315	7470833		8770333		8970333		8870333		5.8
250	400	7470837		8770337		8970337		8870337		5.8
315	450	7470841		8770341				8870341		5.8
355	500	7470843		8770343				8870343		5.8



aquatherm ti FIBER COMPOSITE PIPE **ONE-SIDED** WITH FLANGE ADAPTER AND LOOSE FLANGE **11.6 M**

Fiber composite pipe as single pipe in 11.6 m length with PUR-rigid foam insulation and PE-casing pipe.

Outside diameter		aquatherm green pipe ti SDR 9		aquatherm blue pipe ti SDR 11		aquatherm blue pipe ot ti SDR 11		aquatherm blue pipe ti SDR 17.6		PU m/pc
Medium pipe [mm]	Casing pipe [mm]	Art. no.	Price € m/pc	Art. no.	Price € m/pc	Art. no.	Price € m/pc	Art. no.	Price € m/pc	
160	250	7470830		8770330		8970330		8870330		11.6
200	315	7470834		8770334		8970334		8870334		11.6
250	400	7470838		8770338		8970338		8870338		11.6
315	450	7470842		8770342				8870342		11.6
355	500	7470844		8770344				8870344		11.6

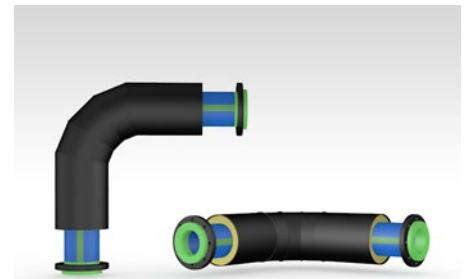
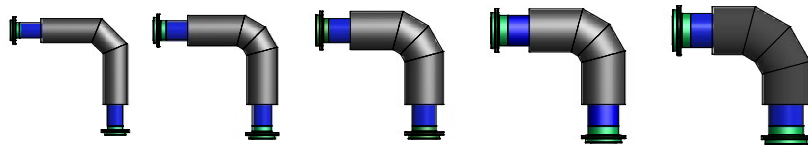

aquatherm ti **ELBOW 90° TWO-SIDED** WITH FLANGE ADAPTER AND LOOSE FLANGE

with PUR-rigid foam insulation and PE-casing pipe

Outside diameter		aquatherm green pipe ti SDR 9		aquatherm blue pipe ti SDR 11		aquatherm blue pipe ot ti SDR 11		aquatherm blue pipe ti SDR 17.6		PU pc
Medium pipe [mm]	Casing pipe [mm]	Art. no.	Price € m/pc	Art. no.	Price € m/pc	Art. no.	Price € m/pc	Art. no.	Price € m/pc	
160	250	7412130		8712131		8912131		8812130		1
200	315	7412134		8712135		8912135		8812134		1
250	400	7412138		8712139		8912139		8812138		1
315	450	7412142		8712143				8812142		1
355	500	7412144		8712145				8812144		1

On demand also available in design 60° and 75°



Management
System
ISO 9001:2015
ISO 14001:2015
ISO 50001:2011
www.tuv.com
ID 0091005348

aquatherm GmbH

Biggen 5 | D-57439 Attendorn | Phone: +49 (0) 2722 950-0 | Fax: +49 (0) 2722 950-100
info@aquatherm.de www.aquatherm.de

Order-No.: E10101
Edition: 2.2019

aquatherm - Pipe systems made of polypropylene